



**DISTRICT OF COLUMBIA**

# **STORMWATER MANAGEMENT GUIDEBOOK**

**January 2020**





**Prepared Under:**

Grant No. 2015-1508-WPD

Grant No. 2018-1819-SWR

**Prepared for:**

Department of Energy and Environment  
Regulatory Review Division  
1200 First Street NE  
Washington, DC 20002  
<https://doee.dc.gov/>

**Prepared by:**

Center for Watershed Protection, Inc.  
3290 North Ridge Road, Suite 290  
Ellicott City, MD 21043  
<http://www.cwp.org/>



## Acknowledgements

A major undertaking such as this requires the dedication and cooperative efforts of many individuals. Jeff Seltzer, Deputy Director of Natural Resources; Brian VanWye, Associate Director of Regulatory Review; and Timothy Karikari, Branch Chief of Building Permit Plan Review deserve credit for their overall leadership and support for this project. Their willingness to allow staff to pursue ideas to their fullest and provide necessary time, resources, and managerial support laid the foundation for much innovation.

### Project Managers

James Dunbar, DOEE-Regulatory Review Division  
Julienne Bautista, DOEE-Regulatory Review Division

### Lead Authors

Greg Hoffmann, P.E., Center for Watershed Protection  
Laura Gardner, P.E., formerly Center for Watershed Protection  
Matthew Espie, DOEE-Regulatory Review Division  
James Dunbar, DOEE-Regulatory Review Division

### Editors

Geoffrey Brown, DOEE-Natural Resources Administration  
Scott Drew, formerly DOEE-Natural Resources Administration  
Sherry Schwechten, formerly DOEE-Natural Resources Administration

### Contributors and Peer Reviewers

Timothy Karikari, P.E., CPESC, CFM, DOEE- Regulatory Review Division  
Margaret Noonan, DOEE-Regulatory Review Division  
Abdi Musse, P.E., DOEE-Building Permit Plan Review  
Dillon Goodell, formerly DOEE-Regulatory Review Division  
Julienne Bautista, DOEE-Regulatory Review Division  
Saba Gharavi, DOEE-Regulatory Review Division  
Elias Demessie, P.E., CFM, DOEE-Regulatory Review Division  
Massoud Massoumi, formerly DOEE-Regulatory Review Division  
Rickeisha (Ricki) Goldsby, DOEE-Inspection and Enforcement Division  
Walter Caldwell, DOEE-Inspection and Enforcement Division  
Matt Watkins, DOEE-Inspection and Enforcement Division  
Kokob Woldeyesus, Ph.D, DOEE-Inspection and Enforcement Division  
Lillian Peterson, formerly DOEE-Inspection and Enforcement Division  
Alecia Jenkins, DOEE-Inspection and Enforcement Division  
Nathaniel Lichten, DOEE-Regulatory Review Division  
Matthew Espie, DOEE-Regulatory Review Division  
Matt Johnson, DOEE-Regulatory Review Division  
Cecilia Lane, DOEE-Watershed Protection Division  
Ed Dunne, DOEE-Water Quality Division  
Phetmano Phannavong, P.E., C.F.M., formerly DOEE-Regulatory Review Division  
Stephen Reiling, DOEE-Watershed Protection Division

## **Preface**

Technical information and notices regarding updates to the District of Columbia Stormwater Management Guidebook will be available at <https://doee.dc.gov/swguidebook>.



# Contents

<b>Chapter 1</b>	<b>Introduction to the Stormwater Management Guidebook.....</b>	<b>1</b>
1.1	Introduction.....	1
1.2	Purpose and Scope.....	1
1.3	Impacts of Urban Runoff.....	2
1.3.1	Hydrologic Impacts.....	2
1.3.2	Water Quality Impacts.....	4
1.4	References.....	6
<b>Chapter 2</b>	<b>Minimum Control Requirements.....</b>	<b>7</b>
2.1	District of Columbia Stormwater Management Requirements.....	7
2.2	Regulated Site Definition and Examples.....	9
2.3	Stormwater Retention Volume (SWRv).....	10
2.4	Water Quality Treatment Volume (WQTV).....	14
2.5	Requirements and Compliance Flow Charts.....	15
2.6	Control of 2-Year Storm.....	20
2.7	Control of 15-Year Storm.....	22
2.8	Extreme Flood Requirements.....	22
2.9	Minimum Criteria for Determining Extreme Flood Requirements.....	23
2.10	Hydrology Methods.....	24
2.11	Additional Stormwater Management Requirements.....	25
2.12	Exemptions.....	25
2.12.1	Detention for Major Substantial Improvement.....	25
2.12.2	Disturbance for BMP Installation.....	25
2.12.3	Athletic Playing Fields, Permeable Athletic Tracks, and Permeable Playground Surfaces.....	26
2.12.4	Utility Work.....	27
2.13	Practicable Process.....	29
2.13.1	Affordable Housing.....	29
2.13.2	Trails.....	30
2.13.3	Small Structures at Parks.....	30
<b>Chapter 3</b>	<b>Stormwater Best Management Practices (BMPs).....</b>	<b>31</b>
3.1	Standard Stormwater Best Management Practice Design Guidance Format.....	31
3.2	Green Roofs.....	33

3.2.1	Green Roof Feasibility Criteria.....	33
3.2.2	Green Roof Conveyance Criteria.....	35
3.2.3	Green Roof Pretreatment Criteria.....	35
3.2.4	Green Roof Design Criteria.....	35
3.2.5	Green Roof Landscaping Criteria.....	43
3.2.6	Green Roof Construction Sequence.....	45
3.2.7	Green Roof Maintenance Criteria.....	47
3.2.8	Green Roof Stormwater Compliance Calculations.....	49
3.2.9	References.....	49
3.3	Rainwater Harvesting.....	51
3.3.1	Rainwater Harvesting Feasibility Criteria.....	52
3.3.2	Rainwater Harvesting Conveyance Criteria.....	55
3.3.3	Rainwater Harvesting Pretreatment Criteria.....	55
3.3.4	Rainwater Harvesting Design Criteria.....	58
3.3.5	Rainwater Harvesting Landscaping Criteria.....	68
3.3.6	Rainwater Harvesting Construction Sequence.....	68
3.3.7	Rainwater Harvesting Maintenance Criteria.....	69
3.3.8	Rainwater Harvesting: Stormwater Compliance Calculations.....	71
3.3.9	References.....	71
3.4	Impervious Surface Disconnection.....	73
3.4.1	Impervious Surface Disconnection Feasibility Criteria.....	73
3.4.2	Impervious Surface Disconnection Conveyance Criteria.....	76
3.4.3	Impervious Surface Disconnection Pretreatment Criteria.....	76
3.4.4	Impervious Surface Disconnection Design Criteria.....	76
3.4.5	Impervious Surface Disconnection Landscaping Criteria.....	77
3.4.6	Impervious Surface Disconnection Construction Sequence.....	78
3.4.7	Impervious Surface Disconnection Maintenance Criteria.....	79
3.4.8	Impervious Surface Disconnection Stormwater Compliance Calculations.....	80
3.4.9	References.....	81
3.5	Permeable Pavement Systems.....	82
3.5.1	Permeable Pavement Feasibility Criteria.....	83



3.5.2	Permeable Pavement Conveyance Criteria.....	85
3.5.3	Permeable Pavement Pretreatment Criteria .....	86
3.5.4	Permeable Pavement Design Criteria .....	86
3.5.5	Permeable Pavement Landscaping Criteria .....	93
3.5.6	Permeable Pavement Construction Sequence.....	94
3.5.7	Permeable Pavement Maintenance Criteria.....	99
3.5.8	Permeable Pavement Stormwater Compliance Calculations.....	101
3.5.9	References.....	102
3.6	Bioretention.....	104
3.6.1	Bioretention Feasibility Criteria .....	106
3.6.2	Bioretention Conveyance Criteria.....	109
3.6.3	Bioretention Pretreatment Criteria.....	110
3.6.4	Bioretention Design Criteria.....	112
3.6.5	Bioretention Landscaping Criteria.....	126
3.6.6	Bioretention Construction Sequence.....	131
3.6.7	Bioretention Maintenance Criteria.....	133
3.6.8	Bioretention Stormwater Compliance Calculations.....	135
3.6.9	References.....	136
3.7	Filtering Systems .....	139
3.7.1	Filtering Feasibility Criteria.....	148
3.7.2	Filtering Conveyance Criteria.....	149
3.7.3	Filtering Pretreatment Criteria .....	149
3.7.4	Filtering Design Criteria .....	149
3.7.5	Filtering Landscaping Criteria .....	154
3.7.6	Filter Construction Sequence.....	155
3.7.7	Filtering Maintenance Criteria.....	156
3.7.8	Filtering Volume Compliance Calculations.....	158
3.7.9	References.....	158
3.8	Infiltration .....	159
3.8.1	Infiltration Feasibility Criteria .....	161
3.8.2	Infiltration Conveyance Criteria .....	164

3.8.3	Infiltration Pretreatment Criteria.....	164
3.8.4	Infiltration Design Criteria.....	165
3.8.5	Infiltration Landscaping Criteria.....	168
3.8.6	Infiltration Construction Sequence .....	169
3.8.7	Infiltration Maintenance Criteria .....	171
3.8.8	Infiltration Stormwater Compliance Calculations .....	172
3.8.9	References.....	173
3.9	Open Channel Systems .....	174
3.9.1	Open Channel Feasibility Criteria .....	177
3.9.2	Open Channel Conveyance Criteria.....	180
3.9.3	Open Channel Pretreatment Criteria.....	180
3.9.4	Open Channel Design Criteria.....	181
3.9.5	Open Channel Landscaping Criteria.....	190
3.9.6	Open Channel Construction Sequence.....	191
3.9.7	Open Channel Maintenance Criteria.....	193
3.9.8	Open Channel Stormwater Compliance Calculations.....	194
3.9.9	References.....	196
3.10	Ponds.....	197
3.10.1	Pond Feasibility Criteria .....	200
3.10.2	Pond Conveyance Criteria .....	202
3.10.3	Pond Pretreatment Criteria.....	203
3.10.4	Pond Design Criteria.....	203
3.10.5	Pond Landscaping Criteria.....	208
3.10.6	Pond Construction Sequence .....	209
3.10.7	Pond Maintenance Criteria .....	211
3.10.8	Pond Stormwater Compliance Calculations .....	212
3.10.9	References.....	213
3.11	Stormwater Wetlands.....	215
3.11.1	Stormwater Wetland Feasibility Criteria .....	217
3.11.2	Stormwater Wetland Conveyance Criteria .....	219
3.11.3	Stormwater Wetland Pretreatment Criteria.....	220

3.11.4	Stormwater Wetland Design Criteria.....	220
3.11.5	Stormwater Wetland Construction Sequence .....	223
3.11.6	Stormwater Wetland Landscaping Criteria.....	226
3.11.7	Stormwater Wetland Maintenance Criteria .....	230
3.11.8	Stormwater Wetland Stormwater Compliance Calculations .....	232
3.11.9	References.....	232
3.12	Storage Practices.....	233
3.12.1	Storage Feasibility Criteria .....	235
3.12.2	Storage Conveyance Criteria .....	237
3.12.3	Storage Pretreatment Criteria.....	238
3.12.4	Storage Design Criteria.....	239
3.12.5	Storage Landscaping Criteria.....	241
3.12.6	Storage Construction Sequence .....	241
3.12.7	Storage Maintenance Criteria .....	243
3.12.8	Storage Volume Compliance Calculations .....	244
3.12.9	References.....	244
3.13	Proprietary Practices .....	247
3.13.1	Proprietary Practice Feasibility Criteria.....	247
3.13.2	Proprietary Practice Conveyance Criteria.....	247
3.13.3	Proprietary Practice Pretreatment Criteria .....	247
3.13.4	Proprietary Practice Design Criteria .....	247
3.13.5	Proprietary Practice Landscaping Criteria .....	248
3.13.6	Proprietary Practice Construction Sequence.....	248
3.13.7	Proprietary Practice Maintenance Criteria.....	248
3.13.8	Proprietary Practice Stormwater Compliance Calculations.....	249
3.14	Tree Planting and Preservation .....	251
3.14.1	Preserving Existing Trees During Construction .....	251
3.14.2	Planting Trees .....	253
3.14.3	Tree Inspection Criteria .....	259
3.14.4	Tree Maintenance Criteria .....	259
3.14.5	Tree Stormwater Compliance Calculations .....	260

3.14.6	References.....	262
<b>Chapter 4</b>	<b>Selecting and Locating the Most Effective Stormwater Best Management Practice System .....</b>	<b>265</b>
4.1	Choosing Stormwater Management Best Practices (BMPs) .....	265
4.2	Regulatory Compliance .....	266
4.3	Land Use Factors .....	268
4.4	Physical Feasibility Factors .....	269
4.5	Community and Environmental Factors .....	271
4.6	Location and Permitting Considerations.....	275
4.7	References.....	277
<b>Chapter 5</b>	<b>Administration of Stormwater Management Rules .....</b>	<b>279</b>
5.1	Administration .....	279
5.1.1	Approval Requirements .....	279
5.1.2	Fees .....	279
5.2	Stormwater Management Plans .....	282
5.2.1	Submittal and Review Process of Stormwater Management Plans .....	282
5.2.2	SWMP Submittal Documents.....	286
5.2.3	SWMP Components.....	286
5.2.4	Resubmission of Stormwater Management Plans.....	290
5.3	Construction Inspection Requirements .....	291
5.3.1	Inspection Schedule and Reports .....	291
5.3.2	Inspection Requirements Before and During Construction .....	292
5.3.3	Final Construction Inspection Reports.....	294
5.3.4	Inspection for Preventive Maintenance .....	294
5.4	Maintenance.....	295
5.4.1	Maintenance Responsibility.....	295
5.4.2	Maintenance Agreement .....	295
5.5	Supporting Forms.....	295
<b>Chapter 6</b>	<b>Use of Off-Site Retention by Regulated Sites.....</b>	<b>329</b>
6.1	Off-Site Retention Overview .....	329
6.2	Minimum On-Site Retention Requirement.....	330
6.3	Off-Site Retention via Stormwater Retention Credits .....	331
6.4	Off-Site Retention via In-Lieu Fee .....	334

6.5	Forms for Use of Off-Site Retention .....	334
<b>Chapter 7</b>	<b>Generation, Certification, Trading, and Retirement of Stormwater Retention Credits</b>	<b>335</b>
7.1	Stormwater Retention Credits Overview .....	335
7.2	Eligibility Requirements .....	335
7.2.2	Eligibility Requirements: Retention Volume.....	338
7.2.3	Eligibility Requirements: Design and Installation.....	339
7.2.4	Eligibility Requirements: Inspection .....	340
7.2.5	Eligibility Requirements: Maintenance .....	340
7.3	Certification of Stormwater Retention Credits .....	340
7.3.1	Certification of SRCs: Process.....	340
7.3.2	Certification of SRCs: DOEE-Funded Projects.....	342
7.4	Format of SRC Serial Numbers .....	342
7.5	Failure to Maintain Retention after Certification of Stormwater Retention Credits ...	343
7.6	Buying and Selling Stormwater Retention Credits on the Market .....	343
7.7	Voluntary Retirement of Stormwater Retention Credits .....	343
7.8	Quitting the Obligation to Maintain Retention for Stormwater Retention Credits.....	344
7.9	Calculation of Stormwater Retention Credits .....	344
7.10	Stormwater Retention Credit Calculation Scenarios .....	345
7.11	Forms for Stormwater Retention Credits.....	349
<b>Appendix A</b>	<b>Compliance Calculations and Design Examples.....</b>	<b>A-1</b>
A.1	Stormwater Database and General Retention Compliance .....	A-1
A.2	Compliance Calculations and Concepts.....	A-1
A.3	Design Examples .....	A-7
<b>Appendix B</b>	<b>Maximum Extent Practicable Process for Existing Public Right-of-Way ....</b>	<b>B-1</b>
B.1	Maximum Extent Practicable: Overview .....	B-1
B.2	Public Right-of-Way Projects .....	B-1
B.3	Codes.....	B-4
B.4	PROW Design Considerations.....	B-5
B.4.1	Considerations in the Planning Process (limited to Type 1).....	B-5
B.4.2	Site Assessment Considerations for the Retention Standard in PROW Projects..	B-5
B.4.3	Fundamental Tenets of MEP for PROW .....	B-10
B.4.4	Minor Disturbances in the PROW .....	B-10

<b>B.4.5</b>	Design Modifications for Infiltration-Based PROW BMPs for Type 1 Projects	B-11
<b>B.5</b>	Design Process for PROW	B-12
<b>B.6</b>	Summary of MEP Type 1 Submission Process	B-16
<b>B.7</b>	References	B-17
<b>Appendix C</b>	<b>Practicable Process</b>	<b>C-1</b>
<b>C.1</b>	Introduction	C-1
<b>C.1.1</b>	Practicability Definition	C-1
<b>C.1.2</b>	Practicable Factors and Considerations	C-1
<b>C.2</b>	Practicable BMPs	C-2
<b>C.3</b>	Plan review process and approval	C-3
<b>Appendix D</b>	<b>Off-Site Retention Forms for Regulated Sites</b>	<b>D-1</b>
<b>Appendix E</b>	<b>Stormwater Retention Credit Forms (Certification, Trading, and Retirement)</b>	<b>E-1</b>
<b>Appendix F</b>	<b>- Relief from Extraordinarily Difficult Site Conditions</b>	<b>F-1</b>
<b>F.1</b>	Relief from Extraordinarily Difficult Site Conditions	F-1
<b>F.2</b>	Submission requirements for Relief from Extraordinarily Difficult Site Conditions	F-2
<b>F.3</b>	Review of Requests for Relief from Extraordinarily Difficult Site Conditions	F-3
<b>Appendix G</b>	<b>Stormwater Conveyance System Design</b>	<b>G-1</b>
<b>G.1</b>	Introduction	G-1
<b>G.2</b>	Clearance with Other Utilities	G-1
<b>G.3</b>	Design of Stormwater Conveyance Systems	G-1
<b>G.4</b>	Gutters	G-2
<b>G.5</b>	Inlets	G-3
<b>G.6</b>	Street Capacity (Spread)	G-3
<b>G.7</b>	Manhole and Inlet Energy Losses	G-3
<b>G.8</b>	Open Channels	G-4
<b>G.9</b>	Pipe Systems	G-5
<b>G.10</b>	Culverts	G-5
<b>G.11</b>	Hydraulic Grade Line	G-8
<b>G.12</b>	Manholes and Inlets	G-8
<b>Appendix H</b>	<b>Design of Flow Control Structures</b>	<b>H-1</b>
<b>H.1</b>	Circular Orifices	H-1
<b>H.2</b>	Weirs	H-2

<b>Appendix I - Acceptable Hydrologic Methods and Models.....</b>	<b>I-1</b>
<b>I.1</b> Acceptable Hydrologic Methods and Models.....	I-1
<b>I.2</b> Urban Hydrology for Small Watersheds TR-55 .....	I-2
<b>I.3</b> Storage-Indication Routing.....	I-12
<b>I.4</b> HEC-1, WinTR-55, TR-20, and SWMM Computer Models .....	I-31
<b>I.5</b> Rational Method.....	I-31
<b>I.6</b> Stormwater Volume Peak Discharge .....	I-32
<b>I.7</b> References.....	I-34
<b>Appendix J Rooftop Storage Design Guidance and Criteria.....</b>	<b>J-1</b>
<b>Appendix K Soil Compost Amendment Requirements .....</b>	<b>K-1</b>
<b>K.1</b> Introduction.....	K-1
<b>K.2</b> Physical Feasibility and Design Applications.....	K-1
<b>K.3</b> Design Criteria.....	K-1
<b>K.4</b> Construction Sequence.....	K-3
<b>K.5</b> Maintenance.....	K-4
<b>K.6</b> References.....	K-5
<b>Appendix L Construction Inspection Checklists .....</b>	<b>L-1</b>
<b>Appendix M Maintenance Inspection Checklists .....</b>	<b>M-1</b>
<b>Appendix N Rainwater Harvesting Treatment and Management Requirements .....</b>	<b>N-1</b>
<b>N.1</b> Introduction.....	N-1
<b>N.2</b> Pathogen Reduction Targets .....	N-1
<b>N.3</b> Treatment Process.....	N-2
<b>N.3.1</b> Filtration.....	N-2
<b>N.3.2</b> Disinfection.....	N-3
<b>N.3.3</b> Treatment Trains.....	N-5
<b>N.4</b> Volatile Organic Compounds .....	N-5
<b>N.5</b> Storage and Distribution Management Practices.....	N-6
<b>N.6</b> Commissioning .....	N-8
<b>N.7</b> Operational Monitoring and Reporting.....	N-8
<b>N.8</b> Field Verification.....	N-9
<b>N.9</b> Design Report .....	N-9
<b>N.10</b> Treatment Design Examples.....	N-10
<b>N.10.1</b> Example 1: Rooftop Runoff for Landscape Irrigation.....	N-10
<b>N.10.2</b> Example 2: General Runoff for Landscape Irrigation .....	N-11

<b>N.10.2</b>	Example 3: General Runoff for Indoor Use.....	N-13
<b>N.10.3</b>	Example 4: Roof Runoff for Cooling Towers .....	N-14
<b>N.11</b>	References.....	N-15
<b>Appendix O</b>	<b>Land Cover Designations.....</b>	<b>O-1</b>
<b>O.1</b>	General Notes.....	O-1
<b>O.2</b>	Existing Natural Cover Requirements .....	O-1
<b>O.3</b>	Planting Requirements for the Creation of Natural Cover.....	O-1
<b>O.4</b>	Stormwater Management Plans and Natural Cover.....	O-2
<b>O.5</b>	Construction Requirements for Natural Cover Designation.....	O-3
<b>O.6</b>	Maintenance Requirements for Natural Cover Designation.....	O-4
<b>O.7</b>	Compacted Cover Designation .....	O-4
<b>O.8</b>	Impervious Cover Designation .....	O-4
<b>Appendix P</b>	<b>Geotechnical Information Requirements for Underground BMPs.....</b>	<b>P-1</b>
<b>P.1</b>	General Notes Pertinent to All Geotechnical Testing.....	P-1
<b>P.2</b>	Initial Feasibility Assessment .....	P-1
<b>P.3</b>	Test Pit/Boring Requirements for Infiltration Tests .....	P-2
<b>P.4</b>	Infiltration Testing Requirements .....	P-3
<b>P.5</b>	Saturated Hydraulic Conductivity Calculations.....	P-5
<b>P.6</b>	Infiltration Restrictions .....	P-5
<b>Appendix Q</b>	<b>Stormwater Hotspots .....</b>	<b>Q-1</b>
<b>Q.1</b>	Stormwater Hotspots.....	Q-1
<b>Q.2</b>	Stormwater Hotspot Cover Sheet.....	Q-2
<b>Q.3</b>	Stormwater Hotspot Checklist .....	Q-3
<b>Q.4</b>	Hotspot Operation Pollution Prevention Profile Sheets.....	Q-9
<b>Appendix R</b>	<b>Pollution Prevention Through Good Housekeeping .....</b>	<b>R-1</b>
<b>R.1</b>	Pollution Prevention.....	R-1
<b>R.2</b>	Stormwater Management Plan (SWMP) Good Housekeeping Stamp Notes .....	R-1
<b>Appendix S</b>	<b>Integrated Pest Management .....</b>	<b>S-1</b>
<b>S.1</b>	Integrated Pest Management.....	S-1
<b>S.2</b>	Components of an Integrated Pest Management Plan .....	S-1
<b>S.3</b>	Sample Form for an Integrated Pest Management Plan.....	S-3
<b>Appendix T</b>	<b>Proprietary Practices Approval Process .....</b>	<b>T-1</b>
<b>T.1</b>	Proprietary Practice Consideration Overview .....	T-1
<b>T.2</b>	Types of Manufactured Treatment Devices.....	T-1



<b>T.3</b>	Proprietary Practice Approval Process – Background.....	T-2
<b>T.4</b>	MTD Current Approval Status.....	T-3
<b>T.5</b>	MTD Approval Status Renewal.....	T-4
<b>T.6</b>	MTD Application Fees .....	T-4
<b>T.7</b>	References.....	T-4
<b>Appendix U Underground Sand Filter Design Example.....</b>		<b>U-1</b>
<b>Appendix V Examples of Regulated Activities.....</b>		<b>1</b>
<b>Appendix W Site Drainage Area and BMP Design Diagrams.....</b>		<b>W-1</b>
<b>W.1</b>	Design Diagram Overview .....	W-1
<b>W.2</b>	Site Drainage Area Diagrams .....	W-1
<b>W.3</b>	Determining When BMP Performance is Considered to be On-Site.....	W-5
<b>Appendix X Resources.....</b>		<b>X-1</b>
<b>Appendix Y Definitions .....</b>		<b>Y-1</b>
<b>Y.1</b>	References.....	Y-11

## List of Tables

Table 1-1 Common Pollutants in Urban Stormwater Runoff and Their Sources .....	5
Table 2-1 Sizing Criteria for Stormwater Management Performance Requirements.....	8
Table 2-2 Rainfall Depth for Construction Activities that Require Stormwater Management ....	10
Table 3-1 Extensive Green Roof Material Specifications .....	39
Table 3-2 Ground Covers Appropriate for Green Roofs in the District of Columbia .....	44
Table 3-3 Typical Maintenance Activities Associated with Green Roofs.....	48
Table 3-4 Green Roof Design Performance.....	49
Table 3-5 Advantages and Disadvantages of Typical Cistern Materials (Source: Cabell Brand Center, 2007; Cabell Brand Center, 2009).....	60
Table 3-6 Design Specifications for Rainwater Harvesting Systems .....	61
Table 3-7 Typical Maintenance Tasks for Rainwater Harvesting Systems .....	70
Table 3-8 Feasibility Criteria for Simple Disconnection.....	74
Table 3-9 Recommended Vegetation for Pervious Disconnection Areas .....	78
Table 3-10 Disconnection Retention Value and Pollutant Removal .....	80
Table 3-11 Permeable Pavement Specifications for a Variety of Typical Surface Materials .....	90
Table 3-12 Material Specifications for Typical Layers Beneath the Pavement Surface .....	90
Table 3-13 Typical Maintenance Tasks for Permeable Pavement Practices .....	99
Table 3-14 Enhanced Permeable Pavement Retention Value and Pollutant Removal.....	101
Table 3-15 Enhanced with Underdrain Pavement Retention Value and Pollutant Removal .....	101
Table 3-16 Standard Permeable Pavement Retention Value and Pollutant Removal .....	102
Table 3-17 Maximum Contributing Drainage Area to Bioretention .....	107
Table 3-18 Filter Media Grain Size Distribution.....	114
Table 3-19 Summary of Filter Media Criteria for Bioretention .....	116
Table 3-20 Determining Maximum Filter Media Depth (feet).....	117
Table 3-21 Bioretention Material Specifications.....	120
Table 3-22 Herbaceous Plants Appropriate for Bioretention Areas in the District .....	127
Table 3-23 Woody Plants Appropriate for Bioretention Areas in the District .....	129
Table 3-24 Typical Maintenance Tasks for Bioretention Practices.....	134
Table 3-25 Enhanced Bioretention Retention Value and Pollutant Removal.....	136
Table 3-26 Standard Bioretention Design Retention Value and Pollutant Removal.....	136
Table 3-27 Filtering Practice Material Specifications .....	153
Table 3-28 Typical Annual Maintenance Activities for Filtering Practices .....	157
Table 3-29 Filter Retention Value and Pollutant Removal.....	158
Table 3-30 Typical Maintenance Activities for Infiltration Practices .....	171
Table 3-31 Infiltration Retention Value and Pollutant Removal .....	172
Table 3-32 Typical Check Dam Spacing to Achieve Effective Channel Slope .....	182
Table 3-33 Grass Channel Material Specifications .....	184
Table 3-34 Dry Swale Material Specifications.....	185
Table 3-35 Recommended Vegetation for Open Channels .....	190
Table 3-36 Typical Maintenance Activities and Schedule for Open Channels .....	194
Table 3-37 Grass Channel Retention Value and Pollutant Removal .....	195
Table 3-38 Standard Bioretention Design Retention Value and Pollutant Removal.....	195
Table 3-39 Dry Swale Retention Value and Pollutant Removal .....	195
Table 3-40 Wet Swale Retention Value and Pollutant Removal.....	195

Table 3-41 Clay Liner Specifications .....	205
Table 3-42 Pond Maintenance Tasks and Frequency .....	211
Table 3-43 Pond Retention Value and Pollutant Removal .....	213
Table 3-44 Popular, Versatile, and Available Native Trees and Shrubs for Stormwater Wetlands .....	227
Table 3-45 Popular, Versatile, and Available Native Emergent and Submergent Vegetation for Stormwater Wetlands.....	228
Table 3-46 Stormwater Wetland Retention Value and Pollutant Removal .....	232
Table 3-47 Typical Maintenance Activities for Storage Practices .....	243
Table 3-48 Storage Retention Value and Pollutant Removal .....	244
Refer to the planting guides provided by DOEE’s Green Area Ratio Guidebook to determine plant species’ average mature canopy spread. Table 3-49 Selecting Priority Trees and Forests for Preservation.....	252
Table 3-50 Methods for Addressing Urban Planting Constraints.....	254
Table 3-51 Tree Planting Techniques .....	255
Table 3-52 Preserved Tree Retention Value and Pollutant Removal .....	261
Table 3-53 Planted Tree Retention Value and Pollutant Removal .....	261
Table 4-1 BMP Selection Based on Regulatory Criteria .....	267
Table 4-2 BMP Selection Based on Land Use Screening Factors.....	268
Table 4-3 BMP Selection Based on Physical Feasibility Screening Factors.....	270
Table 4-4 Selection of Infiltration BMPs Based on Measured Saturated Hydraulic Conductivity .....	271
Table 4-5 BMP Selection Based on Community and Environmental Factors.....	273
Table 4-6 Location and Permitting Considerations .....	275
Table 6-1 SRCs that a Site Can Use .....	333
Table 7-1 Standard Bioretention Design Retention Value and Pollutant Removal.....	342
Table G.1 Manning’s Roughness Coefficient (n) Values for Various Channel Materials .....	G-2
Table G.2 Minimum Structure Loss to Use in Hydraulic Grade Line Calculation .....	G-4
Table I.1 Runoff Coefficient Factors for Typical District of Columbia Land Uses .....	I-32
Table K.1 Method to Determine Compost and Incorporation Depths.....	K-2
Table N.1 Ninety-Fifth Percentile Log <sub>10</sub> Pathogen Reduction Targets (LRT) to Meet 10 <sup>-4</sup> (infection) ppy Benchmarks for Healthy Adults <sup>a</sup> .....	N-2
Table N.2 Typical Values for Pathogen Reduction Using Filtration Processes .....	N-3
Table N.3 Typical Values for Various Levels of the Inactivation of Enteric Virus in Filtered Secondary Effluent with Selected Disinfection Processes.....	N-3
Table N.4 Typical Values for Various Levels of the Inactivation of Parasitic Protozoa in Filtered Secondary Effluent with Selected Disinfection Processes.....	N-4
Table N.5 Typical Values for Various Levels of the Inactivation of Enteric Bacteria in Filtered Secondary Effluent with Selected Disinfection Processes.....	N-4
Table N.6 Volatile Organic Compound Maximum Concentrations .....	N-5
Table P.1 Number of Infiltration Tests Required per BMP.....	P-3
Table Q.1 Pollution Prevention Considerations for Vehicle Maintenance and Repair .....	Q-12

## List of Figures

Figure 1.1 Changes in the water balance resulting from urbanization (FISRWG, 1998).....	3
Figure 1.2 Changes in streamflow resulting from urbanization (Schueler, 1987).....	4
Figure 2.1 Map of the Anacostia Waterfront Development Zone. ....	9
Figure 2.2 Map of District of Columbia MS4 and CSS areas. ....	13
Figure 2.3 Determining the regulatory event used to calculate the SWRv.....	16
Figure 2.4 Determining if the site is an AWDZ site. ....	17
Figure 2.5 Determining if the minimum SDA requirements have been met. ....	18
Figure 2.6 Determining if minimum retention and water quality treatment requirements have been met. ....	19
Figure 2.7 Map of drainage types in the District. The Tidal MS4 areas in light blue may be exempt from 2-year detention requirements. ....	21
Figure 2.8 Utility trench exemption example with building in LOD. ....	28
Figure 2.9 Utility trench exemption example with building and sidewalk in LOD. ....	28
Figure 2.10 Utility trench exemption example solely for utility work. ....	29
Figure 3.1 Typical layers for a green roof. Note: the relative placement of various layers may vary depending on the type and design of the green roof system. ....	36
Figure 3.2 Optional overflow channels for rock wool drainage layer. ....	41
Figure 3.3 Design requirements for structures constructed above green roofs.....	42
Figure 3.4 Example of a rainwater harvesting system detail. ....	52
Figure 3.5 Diagram of a first flush diverter. (Texas Water Development Board, 2005).....	57
Figure 3.6 Diagram of a roof washer. (Texas Water Development Board, 2005).....	57
Figure 3.7 Cistern Design 1: Storage associated with the design storm volume only.....	62
Figure 3.8 Cistern Design 2: Storage associated with design storm, channel protection, and flood volume.....	63
Figure 3.9 Cistern Design 3: Constant drawdown version where storage is associated with design storm, channel protection, and flood volume.....	64
Figure 3.10 Incremental design volumes associated with cistern sizing. ....	65
Figure 3.11 Example of available storage volume and overflow volume for various cistern sizes in a hypothetical example. ....	67
Figure 3.12 Design requirements for rooftop and impervious surfaces.....	75
Figure 3.13 Cross section of a standard permeable pavement design. ....	82
Figure 3.14 Cross section of an enhanced permeable pavement design with an underdrain.....	83
Figure 3.15 Cross section of an enhanced standard permeable pavement design without an underdrain. ....	83
Figure 3.16 Use of flow barriers to encourage infiltration on sloped sites.....	87
Figure 3.17 Example of standard bioretention design. ....	105
Figure 3.18 Example of an enhanced bioretention design with an underdrain and infiltration sump/storage layer. ....	105
Figure 3.19 Example of enhanced bioretention design without an underdrain. ....	106
Figure 3.20 Example of an overflow structure in an on-line bioretention area. ....	110
Figure 3.21 Observation well/cleanout device.....	119
Figure 3.22 Example of tree box cross section. ....	122
Figure 3.23 Example of tree box cross section with compacted media extending below sidewalk. ....	123

Figure 3.24 Example of a stormwater planter (B-4).	124
Figure 3.25 Typical schematic for a surface sand filter (F-2). Note: Material specifications are indicated in Table 3-27.	140
Figure 3.26 Part A – Example of a three-chamber underground sand filter (F-3) for separate sewer areas. Note: Material specifications are indicated in Table 3-27.	141
Figure 3.27 Part B – Example of a three-chamber underground sand filter (F-3) for separate sewer areas. Note: Material specifications are indicated in Table 3.27.	142
Figure 3.28 Part C – Example of a three-chamber underground sand filter (F-3) for separate sewer areas. Note: Material specifications are indicated in Table 3.27.	143
Figure 3.29 Part A – Example of a three-chamber underground sand filter (F-3) for combined sewer areas. Note: Material specifications are indicated in Table 3.27.	144
Figure 3.30 Part B – Example of a three-chamber underground sand filter (F-3) for combined sewer areas. Note: Material specifications are indicated in Table 3.27.	145
Figure 3.31 Part C – Example of a three-chamber underground sand filter (F-3) for combined sewer areas. Note: Material specifications are indicated in Table 3.27.	146
Figure 3.32 Example of a perimeter sand filter (F-4).	147
Figure 3.33 Example of an infiltration trench.	159
Figure 3.34 Infiltration section with supplemental pipe storage.	160
Figure 3.35 Example of an infiltration basin.	161
Figure 3.36 Grass channel typical plan, profile, and section views (O-1).	175
Figure 3.37 Example of a dry swale (O-2).	176
Figure 3.38 Example of a wet swale (O-3).	177
Figure 3.39 Design schematics for a wet pond (C-2).	198
Figure 3.40 Typical extended detention pond (C-3) details.	199
Figure 3.41 Example of extended detention shallow wetland.	216
Figure 3.42 Cross section of a typical stormwater wetland.	217
Figure 3.43 Interior wetland zones: (I) Deep Pool (depth -48 to -18 inches), (II) Transition Zone (depth -18 to -6 inches), (III and IV) High Marsh Zone (depth -6 to +6 inches), (IV) Temporary Inundation Area, and (V) Upper Bank (adapted from Hunt et al., 2007).	217
Figure 3.44 Example of an underground detention vault and/or tank (S-1).	234
Figure 3.45 Example of a dry detention pond (S-2).	235
Figure 3.46 Tree planting guidelines. (Adapted from Flott, 2004 and ISA, 2003b).	256
Figure 3.47 The specifications for planting on a steep slope, require creating a level planting surface.	257
Figure 3.48 Deer protection cage. (Adapted from Montgomery County, MD M-NCPPC).	259
Figure 5.1 Fees.	281
Figure 5.2 Plan review process.	284
Figure 5.3 Construction inspection and maintenance process.	285
Figure 5.4 DC Water/DOEE Storm Sewer Verification form.	297
Figure 5.5 As-Built Certification By Professional Engineer form.	298
Figure 5.6 Statement By Professional Engineer Registered In the District of Columbia form.	299
Figure 5.7 Statement By Person Responsible For Maintenance form.	300
Figure 5.8 Statement By Person Responsible For Achieving Off-Site Retention form.	301
Figure 5.9 Anacostia Waterfront Development Zone Site form.	302
Figure 5.10 Application for exempt land-disturbing activity.	303
Figure 5.11 Declaration of Covenants Template.	306

Figure 5.12 Amendment to Seclaration of Covenants.....	315
Figure 5.12 (continued).....	321
Figure 5.13 Termination and Release of Declaration of Covenants.....	322
Figure 5.13 (continued).....	326
Figure 7.1 SRC Eligibility Cutoff Dates.....	337
Figure 7.2 Retention volume eligible to earn SRCs. ....	339
Figure 7.3 Scenario 1.....	346
Figure 7.4 Land Cover Type.....	347
Figure 7.5 BMP Design Information.....	347
Figure 7.6 Scenario 2.....	348
.....	349
Figure 7.7 Land Cover and Pre-Project BMP Information.....	349
Figure 7.8 BMP Design Information.....	349
Figure A.1 Approximate detention basin routing for rainfall types I, IA, II and III.....	A-13
Figure B.1 Diagram of typical residential public right-of-way in the District of Columbia (DDOT Public Realm Design Manual 2011).....	B-2
Figure D.1 Application to Use Stormwater Retention Credits for Off-Site Retention Volume.....	D-2
Figure D.2 Notification of In-Lieu Fee Payment to Meet Off-Site Retention Volume.....	D-5
Figure E.1 Application for Certification of Stormwater Retention Credits.....	E-2
Figure E.2 Application for Transfer of Stormwater Retention Credit Ownership.....	E-7
Figure E.3 Application to Retire Stormwater Retention Credits.....	E-10
Figure G.1 Typical nomograph for culverts under outlet control.....	G-7
Figure I.1 Approximate detention basin routing for rainfall types I, IA, II and III.....	I-4
Figure I.4 Approximate detention basin routing for Example 1a.....	I-8
Figure J.1 Rooftop stormwater detention.....	J-3
Figure J.2 Typical rainfall ponding ring sections.....	J-4
Figure L.1 Green Roof Construction Inspection Report.....	L-2
Figure L.2 Rainwater Harvesting Construction Inspection Report.....	L-4
Figure L.3 Impervious Surface Disconnection Construction Inspection Report.....	L-5
Figure L.4 Permeable Pavement System Construction Inspection Report.....	L-6
Figure L.6 Bioretention Construction Inspection Report.....	L-8
Figure L.7 Sand Filter Construction Inspection Report.....	L-10
Figure L.8 Infiltration Device Construction Inspection Report.....	L-12
Figure L.9 Open Channel System Construction Inspection Report.....	L-13
Figure L.10 Pond, Wetland, and Storage Practices Construction Inspection Report.....	L-15
Figure L.11 Stormwater Management Facilities Inspection Report.....	L-16
Figure L.12 Tree Planting and Preservation Construction Inspection Report.....	L-17
.....	L-18
Figure L.14 Stormwater Management Standard Testing Record.....	L-19
Figure L.15 Green Area Ratio Landscape Checklist.....	L-20
Figure M.1 Green Roof Maintenance Inspection Report.....	M-2
Figure M.2 Rainwater Harvesting Maintenance Inspection Report.....	M-4
Figure M.3 Impervious Cover Surface Disconnection Maintenance Inspection Report.....	M-6
Figure M.4 Permeable Pavement Maintenance Inspection Report.....	M-8
Figure M.5 Bioretention Maintenance Inspection Report.....	M-9
Figure M.6 Sandfilter Maintenance Inspection Report.....	M-11

Figure M.7 Infiltration Facilities Maintenance Inspection Report. ....	M-13
Figure M.8 Open Channel Systems Maintenance Inspection Report. ....	M-15
Figure M.9 Pond and Wetland Maintenance Inspection Report. ....	M-16
Figure M.10 Storage and Underground Detention Maintenance Inspection Report. ....	M-18
Figure M.11 Stormwater Management Facilities Maintenance Inspection Report. ....	M-20
Figure M.12 Tree Planting and Preservation Maintenance Inspection Report. ....	M-22
Figure M.13 Maintenance Service Completion Inspection Report. ....	M-23
Figure N.1 Example 1 Treatment Schematic. ....	N-10
Figure N.2 Example 2 Treatment Schematic. ....	N-12
Table N.11 Example 3 LRT for General Runoff. ....	N-13
Figure N.2 Example 3 Treatment Schematic. ....	N-13
Figure P.1 Infiltration restrictions related to site contamination. ....	P-7
Figure Q.1 Vehicle yard. ....	Q-11
Figure Q.2 Covered Retail Gas Operation Without Containment for Potential Spills. ....	Q-15
Figure Q.3 Containment System Preventing Wash Water from Entering the Storm Drain. ....	Q-19
Figure P.4 Unloading Area of Warehouse. ....	Q-22
Figure P.5 Mulch Stored Outdoors at a Garden Center. ....	Q-24
Figure P.6 Secondary Containment of Storage Drums Behind a Car Repair Shop. ....	Q-26
Figure S.1 Sample form for an Integrated Pest Management Plan. ....	S-3
Figure U.1 Sand filter schematic with steps shown. ....	U-2
Figure W.1 Site Drainage Areas on a single lot. ....	W-2
Figure W.2 Site Drainage Areas on projects with multiple lots. ....	W-3
Figure W.3 Site Drainage Areas on campuses. ....	W-4
Figure W.4 Single lot: BMP and CDA are entirely within the LOD. ....	W-7
Figure W.5 Single lot: CDA is partially outside the LOD, but within the lot. ....	W-8
Figure W.6 Single lot: CDA is partially in the PROW. ....	W-9
Figure W.7 Single lot: CDA includes area on an adjacent lot. ....	W-10
Figure W.8 Single lot: BMP and CDA are entirely outside the LOD. ....	W-11
Figure W.9 Single lot: BMP and CDA are outside primary LOD. ....	W-12
Figure W.10 Single lot: BMP is outside primary LOD; CDA includes area within primary LOD. ....	W-13
Figure W.11 Single lot: Tree planting. ....	W-14
Figure W.12 Single lot: Tree preservation. ....	W-15
Figure W.13 Many lots: BMP and CDA are entirely within the LOD. ....	W-16
Figure W.14 Many lots: CDA is partially outside the LOD, but within the disturbed lots. ....	W-17
Figure W.15 Many lots: CDA is partially in the PROW. ....	W-18
Figure W.16 Many lots: CDA includes area on an adjacent lot. ....	W-19
Figure W.17 Many lots: BMP and CDA are entirely outside the LOD. ....	W-20
Figure W.18 Many lots: BMP and CDA are on an adjacent, undisturbed lot. ....	W-21
Figure W.19 Many lots: BMP and CDA are outside primary LOD. ....	W-22
Figure W.20 Many lots: BMP is outside primary LOD; CDA includes area within primary LOD. ....	W-23
Figure W.21 Many lots: Tree planting. ....	W-24
Figure W.22 Many lots: Tree preservation. ....	W-25
Figure W.23 Campus: BMP and CDA are entirely within the LOD. ....	W-26
Figure W.24 Campus: CDA is partially outside the LOD. ....	W-27

Figure W.25 Campus: BMP and CDA are entirely outside the LOD.....	W-28
Figure W.26 Campus: Tree planting.....	W-29
Figure W.27 Campus: Tree preservation.....	W-30
Figure W.28 PROW: BMP and CDA are entirely within the LOD.....	W-31
Figure W.29 PROW: CDA is partially outside the LOD, but within the PROW.....	W-32
Figure W.30 PROW: CDA is partially in an adjacent lot.....	W-33
Figure W.31 PROW: Tree planting.....	W-34
Figure W.32 PROW: Tree preservation.....	W-35
Figure W.33 Shared BMPs.....	W-36



## List of Equations

Equation 2.1 Stormwater Retention Volume .....	10
Equation 2.2 Water Quality Treatment Volume .....	14
Equation 3.1 Storage Volume for Green Roofs .....	43
Equation 3.2 Reservoir Layer Minimum Depth .....	92
Equation 3.3 Drawdown Time .....	92
Equation 3.4 Permeable Pavement Storage Volume .....	93
Equation 3.5 Bioretention Storage Volume .....	125
Equation 3.6 Enhanced Bioretention Infiltration Sump Depth .....	126
Equation 3.7 Bioretention Infiltration Rate Check .....	126
Equation 3.8 Minimum Filter Surface Area for Filtering Practices .....	153
Equation 3.9 Required Ponding Volume for Filtering Practices .....	154
Equation 3.10 Storage Volume for Filtering Practices .....	154
Equation 3.11 Maximum Surface Basin Depth for Infiltration Basins .....	166
Equation 3.12 Maximum Underground Reservoir Depth for Infiltration Trenches .....	167
Equation 3.13 Surface Basin Surface Area for Infiltration Basins .....	167
Equation 3.14 Underground Reservoir Surface Area for Infiltration Trenches .....	167
Equation 3.15 Storage Volume Calculation for Surface Basin Area for Infiltration Basins .....	168
Equation 3.16 Storage Volume Calculation for Underground Reservoir Surface Area for Infiltration Trenches .....	168
Equation 3.17 Manning’s Equation .....	187
Equation 3.18 Continuity Equation .....	187
Equation 3.19 Minimum Width .....	188
Equation 3.20 Corresponding Velocity .....	188
Equation 3.21 Grass Channel Length for Hydraulic Residence Time of 9 minutes (540 seconds) .....	188
Equation 3.22 Grass Channel Storage Volume .....	189
Equation 3.23 Dry Swale Storage Volume .....	189
Equation 3.24 Wet Swale Storage Volume .....	190
Equation 3.25 Pond Storage Volume .....	207
Equation 3.26 Water Balance Equation for Acceptable Water Depth in a Wet Pond .....	208
Equation 3.27 Baseflow Conversion .....	208
Equation 3.28 Stormwater Wetland Storage Volume .....	222
Equation 3.29 Water Balance for Acceptable Water Depth in a Stormwater Wetland .....	222
Equation 3.30 Minimum Depth of the Permanent Pool .....	223



# Chapter 1                      Introduction to the Stormwater Management Guidebook

## 1.1 Introduction

The District of Columbia (District), like most ultra-urban areas, experiences increased stormwater runoff that results from development. This runoff places a burden on sewer systems and degrades aquatic resources when it is not managed adequately. Unmanaged stormwater runoff overloads the capacity of streams and storm sewers and is responsible for increased combined sewer overflow events and adverse downstream impacts, such as flash flooding, channel erosion, surface and groundwater pollution, and habitat degradation.

Recognizing this issue, the District first adopted stormwater management regulations in 1988. These regulations, Chapter 5 of Title 21 of the District of Columbia Municipal Regulations (21 DCMR), established requirements to manage both stormwater quality and quantity. Quality control focused on the removal of pollutants from up to the first 0.5 inch of stormwater runoff, often referred to as the “first flush.” Quantity control was mandated through detention requirements based on the 2-year, 24-hour storm event for stream bank protection (widely accepted as the channel shaping flow) and the 15-year, 24-hour storm event for flood protection (the typical design capacity of the District’s sewer conveyance system).

In 2013, the District’s stormwater management regulations shifted its stormwater quality standard to a retention-based standard. Major land-disturbing activities must retain the volume from a 1.2-inch storm event, and major substantial improvement activities must retain the volume from a 0.8-inch storm event. By keeping stormwater on site, retention practices effectively provide both treatment and additional volume control, significantly improving protection for District waterbodies. The Stormwater Retention Volume (SWRV) can be managed through runoff prevention (e.g., conservation of pervious cover or reforestation), runoff reduction (e.g., infiltration or water reuse), and runoff treatment (e.g., plant/soil filter systems or permeable pavement).

The Stormwater Management Guidebook (SWMG) provides technical guidance on the 2013 and 2019 revisions to the 1988 regulations.

## 1.2 Purpose and Scope

The purpose of the SWMG is to provide the technical guidance required to comply with the District’s stormwater management regulations, including the criteria and specifications engineers and planners use to plan, design, and construct regulated sites and stormwater best management practices (BMPs).

It is the responsibility of the design engineer to review, verify, and select the appropriate BMPs and materials for a specific project and submit to DOEE, as required, all reports, design

computations, worksheets, geotechnical studies, surveys, rights-of-way determinations, etc. Each such required submittal will bear the seal and signature of the professional engineer licensed to practice in the District who is responsible for that portion of the project.

### **1.3 Impacts of Urban Runoff**

Historically, the collective impacts of rooftops, sidewalks, roadways, and other impervious surfaces on District streams and rivers have been divided into two categories, those attributed to changes in hydrologic response or those resulting from human activities. The hydrologic response of an urban area changes when drainage areas become increasingly impervious, causing stormwater runoff volumes, flows, and velocities to increase while base groundwater flows decrease. Small annual storm events that would ideally be captured by the plants and soils of an undeveloped landscape are instead delivered quickly and efficiently through the receiving pipe network to city streams. Human activities in the city, ranging from heavy automobile traffic to use of various chemicals, generate increased pollutant loads. During dry weather, these pollutants combine with deposits of atmospheric pollution from outside of the city to build up on impervious surfaces where rain and snow events later wash them into the District's storm sewer pipes, streams, and rivers.

#### **1.3.1 Hydrologic Impacts**

Urban development causes significant changes in the rainfall-runoff relationship within a watershed. Rainfall volumes shift from evapotranspiration and infiltration to surface and piped runoff. This shift delivers large amounts of runoff to receiving pipes and streams during even the smallest rainfall event within an urban development (see Figure 1.1).

A city represents a transformation from a natural catchment to a sewershed through an increase in impervious surfaces and the addition of an underground, piped conveyance system. Natural drainage patterns are modified and stormwater runoff is channeled through roof drains, pavement, road gutters, and storm drains. Direct connections between impervious surfaces and stormwater conveyance systems (meant to avoid flooding) deliver these larger volumes more quickly, which leads to an increase in runoff volumes and velocities. The time runoff takes to travel downstream becomes shorter, and infiltration into underlying soils and groundwater aquifers decreases or is eliminated (see Figure 1.2).

The District's 1988 stormwater management regulations responded to these volume impacts with a focus on "peak matching," where volume releases were delayed and released at a 2-year flow rate. Recent research has found that this approach has, in many cases, led to an increase in stream erosion because the full runoff volume is still forced through the receiving channel. Even at this low flow rate, the channel is subjected to an elevated flow for prolonged durations.

In addition, a 2-year flow control structure allows the large number of smaller-sized storms to wash off a site at the discharge rate allowed for the 2-year storm, when they should have a lower discharge rate. The District's new stormwater retention requirements complement and improve peak flow matching by retaining stormwater from these smaller storms on-site and reducing the overall runoff volumes that leave the site. Retention is a better approximation of the natural drainage cycle.

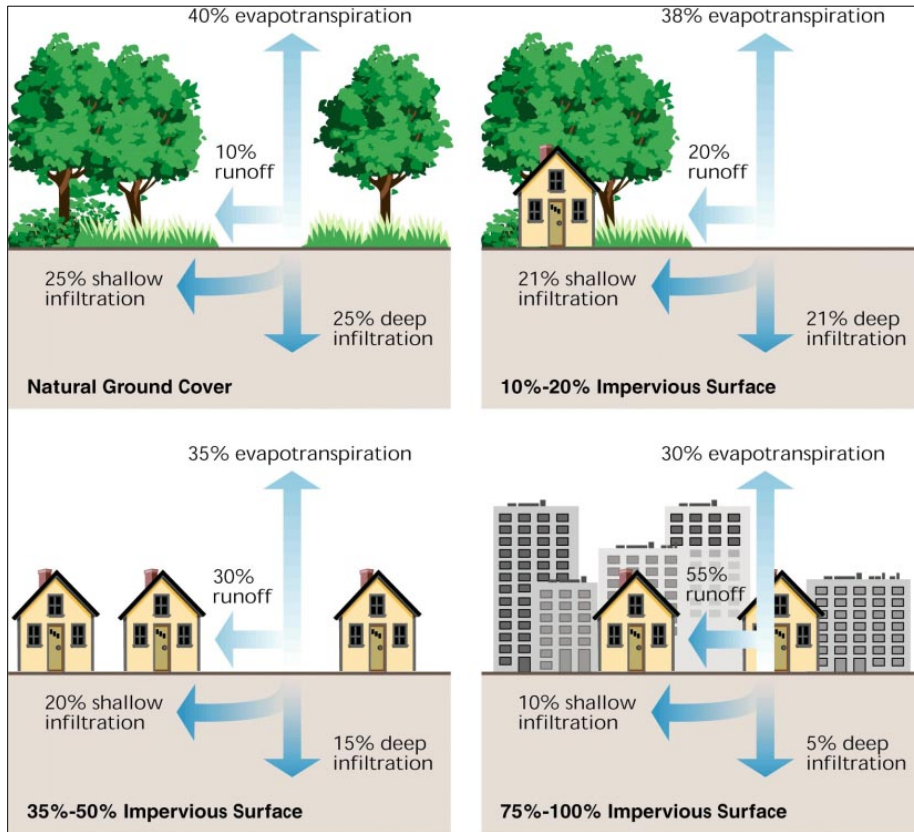


Figure 1.1 Changes in the water balance resulting from urbanization (FISRWG, 1998).

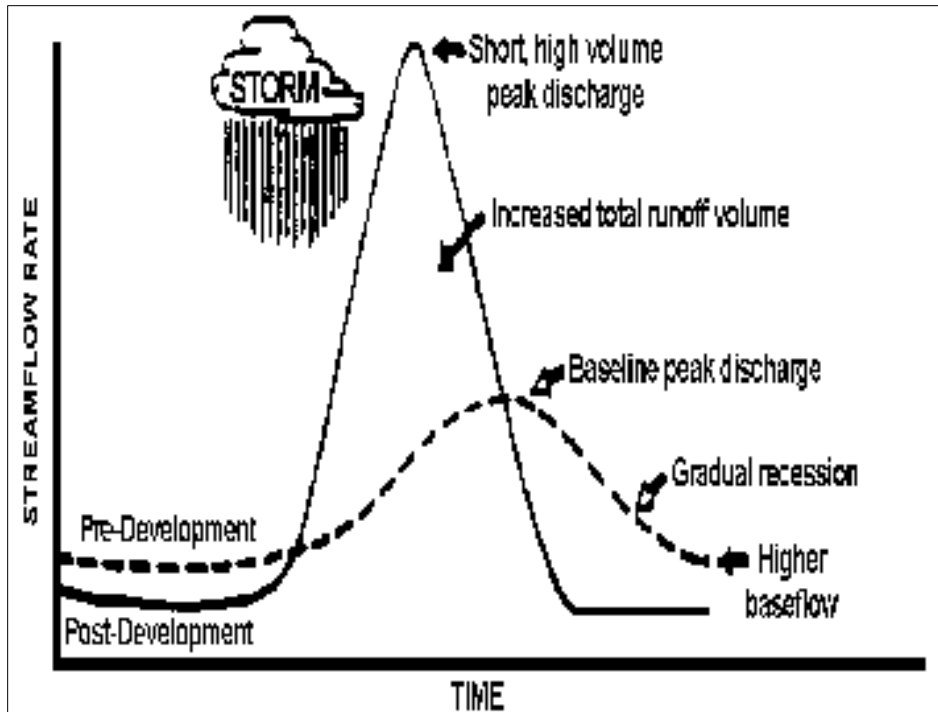


Figure 1.2 Changes in streamflow resulting from urbanization (Schueler, 1987).

### 1.3.2 Water Quality Impacts

As land is developed, impervious surfaces replace naturally vegetated areas that once allowed water to infiltrate and become purified by the soil. Approximately 43% of the District's natural groundcover has been replaced with impervious surfaces, which accumulate pollutants from the atmosphere, from vehicles, and from adjacent areas. During storm events, these pollutants quickly wash off impervious surfaces and are delivered rapidly to downstream waters. Table 1-1 profiles common pollutants found in urban stormwater runoff and their sources.

**Table 1-1 Common Pollutants in Urban Stormwater Runoff and Their Sources**  
(SWQTF, 1993)

Pollutant	Automobile/ Atmospheric Deposition	Urban Housekeeping / Landscaping Practices	Industrial Activities	Construction Activities	Connections other than Stormwater	Accidental Spills and Illegal Dumping
Sediments	X	X	X	X		
Nutrients	X	X	X	X	X	X
Bacteria and Viruses	X	X		X	X	X
Oxygen Demanding Substances		X	X	X	X	X
Oil and Grease	X	X	X	X	X	X
Anti-Freeze	X	X		X	X	X
Hydraulic Fluid	X	X	X	X	X	X
Paint		X		X	X	X
Cleaners and Solvents	X	X	X	X	X	X
Wood Preservatives		X		X	X	X
Heavy Metals	X	X	X	X	X	X
Chromium	X	X	X			
Copper	X	X	X			
Lead	X	X	X			
Zinc	X	X	X			
Iron	X		X			
Cadmium	X		X			
Nickel	X		X			
Magnesium	X		X			
Toxic Materials						
Fuels	X		X	X	X	X
PCBs	X				X	X
Pesticides	X	X	X	X	X	X
Herbicides	X		X	X	X	X
Floatables		X	X	X		

## 1.4 References

- Bannerman, R., D. Owens, R. Dodds, and N. Hornewer. 1993. Sources of Pollutants in Wisconsin Stormwater. *Water Science and Technology*. 28(3-5):241-259.
- California Stormwater Quality Taskforce (SWQTF). 1993. *California Stormwater Best Practices Handbook*.
- The Federal Interagency Stream Restoration Working Group (FISRWG). 1998. *Stream Corridor Restoration: Principles, Processes, and Practices*. GPO Item No. 0120-A; SuDocs No. A 57.6/2:EN 3/PT.653. ISBN-0-934213-59-3
- Schueler, Thomas R. 1987. *Controlling Urban Runoff: A Practice Manual for Planning and Designing Urban BMPs*. Department of Environmental Programs. Metropolitan Washington Council of Governments. Prepared for: Washington Metropolitan Water Resources Planning Board. Washington, DC.
- U.S. Environmental Protection Agency. 1983. *Results of the Nationwide Urban Runoff Program. Volume I. Final Report*. U.S. Environmental Protection Agency, Water Planning Division. Washington, DC.
- Waschbusch et al. 2000. Sources of phosphorus in stormwater and street dirt from two urban residential basins in Madison, Wisconsin, 1994-1995. In: *National Conference on Tools for Urban Water Resource Management and Protection*. US EPA February 2000: pp. 15-55.



# Chapter 2                      Minimum Control Requirements

## 2.1    District of Columbia Stormwater Management Requirements

This chapter describes minimum stormwater management performance requirements for regulated activity and the subsequent sizing of stormwater best management practices (BMPs) in the District of Columbia (District) to retain runoff, meet pollutant removal goals, reduce peak discharges, and control discharges from extreme floods. Table 2-1 presents a summary of the sizing criteria used to achieve the stormwater management performance requirements, which are described in detail later in this chapter. Stormwater management performance requirements refer to these specific aspects of BMP functions, while stormwater management requirements more broadly refer to all requirements under 21 DCMR, Chapter 5.

Those portions of regulated activity that involve the reconstruction of the existing public right-of-way (PROW) are governed by a maximum extent practicable (MEP) approach, detailed in Appendix B, “Maximum Extent Practicable Process for Existing Public Right-of-Way.” Also, there are notes throughout this chapter that identify special conditions for regulated activity located in the Anacostia Waterfront Development Zone (AWDZ) that are governed by the Anacostia Waterfront Environmental Standards Amendment Act of 2012 (see D.C. Official Code §§ 2-1226.36(c)(1)). Figure 2.1 provides a map that outlines the boundaries of the AWDZ, which are also defined in Appendix W.

**Table 2-1 Sizing Criteria for Stormwater Management Performance Requirements**

Sizing Criteria	Description of Stormwater Sizing Criteria
Stormwater Retention Volume (SWR <sub>v</sub> ) (gal) (See Section 2.3)	$SWR_v = \frac{P \times [(Rv_I \times I) + (Rv_C \times C) + (Rv_N \times N)] \times 7.48}{12}$ where: SWR <sub>v</sub> = volume required to be retained (gal) P = variable percentile rainfall event for the District dependent on regulatory trigger (in.) Rv <sub>I</sub> = 0.95 (runoff coefficient for impervious cover and BMP cover) I = impervious cover surface area (ft <sup>2</sup> ) Rv <sub>C</sub> = 0.25 (runoff coefficient for compacted cover) C = compacted cover surface area (ft <sup>2</sup> ) Rv <sub>N</sub> = 0.00 (runoff coefficient for natural cover) N = natural cover surface area (ft <sup>2</sup> ) 7.48 = conversion factor, converting cubic feet to gallons 12 = conversion factor, converting inches to feet
Precipitation value selected based on regulatory trigger (P) (See Section 2.3)	<ul style="list-style-type: none"> <li>• Major land-disturbing activity (AWDZ and District-wide): 90th percentile event (1.2 in.)</li> <li>• Major substantial improvement activity (AWDZ): 85th percentile event (1.0 in.)</li> <li>• Major substantial improvement activity (District-wide): 80th percentile event (0.8 in.)</li> </ul>
Reconstruction of public right-of-way (See Appendix B)	Maximum extent practicable process for existing public right-of-way Consult Appendix B Maximum Extent Practicable Process for Existing Public Right-of-Way
Water Quality Treatment Volume (WQT <sub>v</sub> ) (gal)  (applies only to regulated activity in the AWDZ area governed by the Anacostia Waterfront Environmental Standards Amendment Act of 2012) (See Section 2.4)	$WQT_v = \frac{P \times [(Rv_I \times I) + (Rv_C \times C) + (Rv_N \times N)] \times 7.48}{12} - SWR_v$ where: WQT <sub>v</sub> = volume required to be retained or treated, above and beyond the SWR <sub>v</sub> (gal) P = 95th percentile rain event for the District (1.7 in.) Rv <sub>I</sub> = 0.95 (runoff coefficient for impervious cover and BMP cover) I = impervious cover surface area (ft <sup>2</sup> ) Rv <sub>C</sub> = 0.25 (runoff coefficient for compacted cover) C = compacted cover surface area (ft <sup>2</sup> ) Rv <sub>N</sub> = 0.00 (runoff coefficient for natural cover) N = natural cover surface area (ft <sup>2</sup> ) 7.48 = conversion factor, converting cubic feet to gallons SWR <sub>v</sub> = volume required to be retained (gal) 12 = conversion factor, converting inches to feet
2-Year Storm Control (Q <sub>p2</sub> ) (See Section 2.6)	The post-project peak discharge rate from the 2-year, 24-hour storm event controlled to the predevelopment peak discharge rate
15-Year Storm Control (Q <sub>p15</sub> ) (See Section 2.7)	The post-project peak discharge rate from the 15-year, 24-hour storm event controlled to the pre-project peak discharge rate
Extreme Flood Requirements (Q <sub>f</sub> ) (See Section 2.8)	The post-project peak discharge rate from the 100-year storm event controlled to the pre-project peak discharge rate if the site: 1. Increases the size of a Special Flood Hazard Area (SFHA) as delineated on the effective Flood Insurance Rate Map (FIRM) or

	<p>2. Meets the following two conditions:</p> <ul style="list-style-type: none"> <li>(a) Does not discharge to the sewer system and</li> <li>(b) Has a post-development peak discharge rate for a 100-year frequency storm event that will cause flooding to a building</li> </ul>
--	--



Figure 2.1 Map of the Anacostia Waterfront Development Zone.

## 2.2 Regulated Site Definition and Examples

Stormwater management requirements are triggered if activities at a site meet the definition of either a major land disturbing activity or a major substantial improvement activity, or both. See Appendix Y – Definitions.

A major substantial improvement activity may include a substantial improvement activity that is not associated with land disturbance. Additionally, a project may include both major land-disturbing activity and major substantial improvement activity. See examples in Appendix W Site Drainage Area and BMP Design Diagrams for how designations of major land disturbing activity and major substantial improvement activity are determined. See Appendix O – Land Cover Designations for further clarification on how land cover is designated.

Sites that undergo a major land-disturbing activity or a major substantial improvement activity must employ BMPs and post-development land cover as is necessary to achieve the Stormwater Retention Volume (SWR<sub>v</sub>) that equals the post-development runoff from the applicable rainfall event, as measured for a 24-hour storm with a 72-hour antecedent dry period. The applicable rainfall depth varies depending on the type of regulated activity and whether the project qualifies as an Anacostia Waterfront Development Zone (AWDZ) project, in which case it must meet the requirements of the Anacostia Waterfront Environmental Standards Amendment Act of 2012. For projects that include more than one type of regulated activity, the SWR<sub>v</sub> is calculated individually for each activity using the applicable rainfall event and then summed together to determine the SWR<sub>v</sub> for the entire site.

**Table 2-2 Rainfall Depth for Construction Activities that Require Stormwater Management**

Type of Activity	Rainfall Depth for AWDZ projects	Rainfall Depth for non-AWDZ projects
Major Land Disturbing	1.2 inches	1.2 inches
Major Substantial Improvement	1.0 inches	0.8 inches
Land Disturbance in the PROW (met to MEP)	1.2 inches	1.2 inches

### 2.3 Stormwater Retention Volume (SWR<sub>v</sub>)

The SWR<sub>v</sub> is the volume of stormwater runoff that is required to be retained. It is calculated as shown in Equation 2.1 for the entire site and for each site drainage area (SDA).

#### Equation 2.1 Stormwater Retention Volume

$$SWR_v = \frac{P \times [(Rv_I \times I) + (Rv_C \times C) + (Rv_N \times N)] \times 7.48}{12}$$

where:

- SWR<sub>v</sub> = volume required to be retained (gal)
- P = variable percentile rainfall event for the District dependent on regulatory trigger:
  - 90th percentile (1.2 inches) for major land-disturbing activity,
  - 85th percentile (1.0 inch) for major substantial improvement activity in the AWDZ and governed by the Anacostia Waterfront Environmental Standards Amendment Act of 2012,
  - 80th percentile (0.8 inch) for other major substantial improvement activities
- Rv<sub>I</sub> = 0.95 (runoff coefficient for impervious cover and BMP cover)
- I = impervious cover surface area (ft<sup>2</sup>)

$Rv_C$	=	0.25 (runoff coefficient for compacted cover)
$C$	=	compacted cover surface area (ft <sup>2</sup> )
$Rv_N$	=	0.00 (runoff coefficient for natural cover)
$N$	=	natural cover surface area (ft <sup>2</sup> )
7.48	=	conversion factor, converting cubic feet to gallons
12	=	conversion factor, converting inches to feet

The surface area of a BMP shall be calculated as part of the impervious cover.

A site may achieve on-site retention by directly conveying volume from the regulated site to a shared BMP with available retention capacity.

A site may achieve the SWR<sub>v</sub> on-site or through a combination of on-site retention and off-site retention under the following conditions:

- If the site is located in the municipal separate storm sewer system (MS4), or drains to the Combined Sewer System (CSS) from a sewershed where combined sewer overflows (CSOs) will be reduced with green infrastructure, the site shall retain on site a minimum of 50% of the SWR<sub>v</sub> calculated for the entire site, unless DOEE approves an application for relief from extraordinarily difficult site conditions (see Appendix F - - Relief from Extraordinarily Difficult Site Conditions). Figure 2.2 provides a map that outlines the boundaries of the District's CSS and MS4 areas. A more detailed map can be found in DOEE's submittal database, the Stormwater Database.
- If the site drains to the CSS from a sewershed where CSOs will be reduced with storage tunnels, there is no minimum on-site retention provided that any Stormwater Retention Credit (SRC) used to meet the Off-Site Retention Volume (Off<sub>v</sub>) is generated from a BMP or land cover change outside the CSS. These sites do not need to request relief from extraordinarily difficult site conditions.
- The site shall use off-site retention for the portion of the SWR<sub>v</sub> that is not retained on site (see Chapter 6 - Use of Off-Site Retention by Regulated Sites and Appendix D - Off-Site Retention Forms for Regulated Sites).
- Regulated activity in the AWDZ must apply for relief from extraordinarily difficult site conditions (see Appendix F - Relief from Extraordinarily Difficult Site Conditions) for any off-site retention even if the minimum 50% on-site requirement has been achieved. These projects may apply to achieve retention compliance with off-site retention based on considerations of technical infeasibility and environmental harm as well as the limited appropriateness of on-site compliance in terms of impact on surrounding landowners or overall benefit to District waterbodies.
- Projects requesting relief from compliance with the minimum on-site retention obligation based on extraordinarily difficult site conditions are subject to the submission and evaluation process detailed in Appendix F - - Relief from Extraordinarily Difficult Site Conditions. Sites granted relief from extraordinarily difficult site conditions are still responsible for the entire SWR<sub>v</sub>, but will be allowed to use off-site retention to achieve more than 50% of the SWR<sub>v</sub>.

Site drainage area (SDA) is defined as the area that drains to a single discharge point from the site or sheet flows from a single area of the site (see Appendix W - Site Drainage Area and BMP Design Diagrams for more information about how to identify SDAs).

Retention in excess of the regulated SWR<sub>v</sub> for one SDA may be applied to the SWR<sub>v</sub> for another SDA for the same project, subject to the following conditions:

- For each SDA that does not drain to the CSS, at least 50% of the SWR<sub>v</sub> must be retained or treated with an accepted practice to remove 80% of total suspended solids (TSS). Figure 2.2 provides a map that outlines the boundaries of the District's CSS and MS4.
- For each SDA that does not drain to the CSS, at least 50% of the SWR<sub>v</sub> from the entire vehicular access area must be treated with an accepted practice to remove 80% of TSS. For vehicular access areas in the PROW that are part of a submission that follows the MEP process, the MEP narrative must identify the opportunities for placement and sizing of accepted practices and, if the minimum treatment volume is not achieved, the restrictions making such treatment impracticable.
- Retention of a volume of stormwater greater than that from a 1.7-inch rainfall event, calculated using the SWR<sub>v</sub> equation with a P equal to 1.7 inches, shall not be counted toward on-site retention.

The following are DOEE-accepted treatment practices to remove 80% of TSS:

- Green Roofs
- Permeable Pavement Systems
- Bioretention
- Filtering Systems
- Infiltration
- Ponds
- Stormwater Wetlands
- Dry Swales
- Wet Swales
- Proprietary practices that have been demonstrated to achieve an 80% reduction in TSS in accordance with the requirements of Appendix T - Proprietary Practices Approval Process.

Major land-disturbing activities in the existing PROW, including activities associated with a major land-disturbing activity on private property, must achieve the SWR<sub>v</sub> to the MEP. The MEP design and review process is detailed in Appendix B - Maximum Extent Practicable Process for Existing Public Right-of-Way.

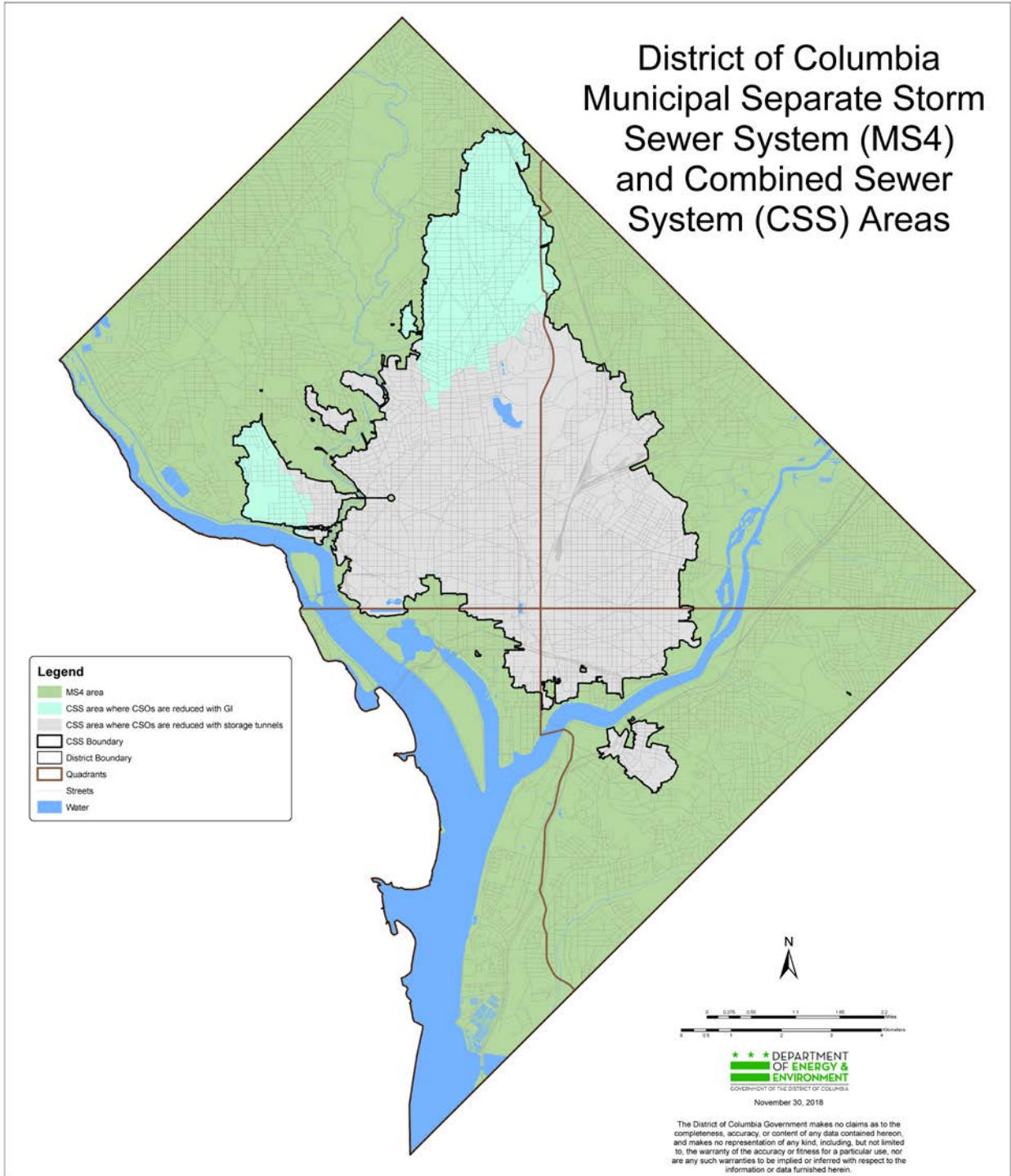


Figure 2.2 Map of District of Columbia MS4 and CSS areas.

## 2.4 Water Quality Treatment Volume (WQTV)

In addition to the SWRV requirements above, sites located in the AWDZ that are publicly owned or publicly financed and governed by the Anacostia Waterfront Environmental Standards Amendment Act of 2012 shall employ BMPs and post-development land cover necessary to achieve a water quality treatment volume (WQTV) equal to the difference between the post-development runoff from the 95th percentile rainfall event (1.7 inches), measured for a 24-hour rainfall event with a 72-hour antecedent dry period, and the SWRV. The WQTV is calculated as shown in Equation 2.2 for the entire site and each individual SDA.

### Equation 2.2 Water Quality Treatment Volume

$$WQTV = \frac{P \times [(Rv_I \times I) + (Rv_C \times C) + (Rv_N \times N)] \times 7.48}{12} - SWRV$$

where:

$WQTV$	=	volume required to be retained or treated beyond the SWRV (gal)
$P$	=	95th percentile rainfall event for the District (1.7 inches)
$Rv_I$	=	0.95 (runoff coefficient for impervious cover and BMP cover)
$I$	=	impervious cover surface area (ft <sup>2</sup> )
$Rv_C$	=	0.25 (runoff coefficient for compacted cover)
$C$	=	compacted cover surface area (ft <sup>2</sup> )
$Rv_N$	=	0.00 (runoff coefficient for natural cover)
$N$	=	natural cover surface area (ft <sup>2</sup> )
7.48	=	conversion factor, converting cubic feet to gallons
$SWRV$	=	volume required to be retained, as described in Section 2.3 (gal)
12	=	conversion factor, converting inches to feet

The surface area of a BMP shall be calculated as part of the impervious cover.

A site in the AWDZ that is governed by the Anacostia Waterfront Environmental Standards Amendment Act of 2012 may achieve on-site treatment for WQTV with the following methods:

- On-site treatment with an accepted practice designed to remove 80% of TSS;
- On-site retention; or
- Direct conveyance of stormwater from the site to an approved shared BMP with sufficient available treatment or retention capacity.

An AWDZ site that is governed by the Anacostia Waterfront Environmental Standards Amendment Act of 2012 may achieve part of the WQTV by using off-site retention if site conditions make compliance technically infeasible or environmentally harmful, DOEE approves an application for “relief from extraordinarily difficult site conditions,” and the off-site retention is from outside the CSS.



An AWDZ site governed by the Anacostia Waterfront Environmental Standards Amendment Act of 2012 that achieves 1 gallon of off-site retention volume (Offv) by using Stormwater Retention Credits (SRCs) certified for retention capacity located outside of the Anacostia watershed shall use 1.25 SRCs for that gallon of Offv.

## **2.5 Requirements and Compliance Flow Charts**

Figures 2.3–2.6 are flow charts that can be used to determine the following for a site:

- The type of regulated activity and the rainfall event needed to determine the SWRv,
- Whether a site is an AWDZ site,
- Whether compliance for SDAs outside of the CSS are met, and
- Whether the site has achieved compliance with the stormwater management requirements.

Note: For major substantial improvement projects, the 2,500 square-foot post-project impervious land cover threshold includes both the renovated building footprint and any accompanying areas of land disturbance. For major land disturbing projects, the 2,500 square-foot post-project impervious land cover threshold only includes land disturbance.

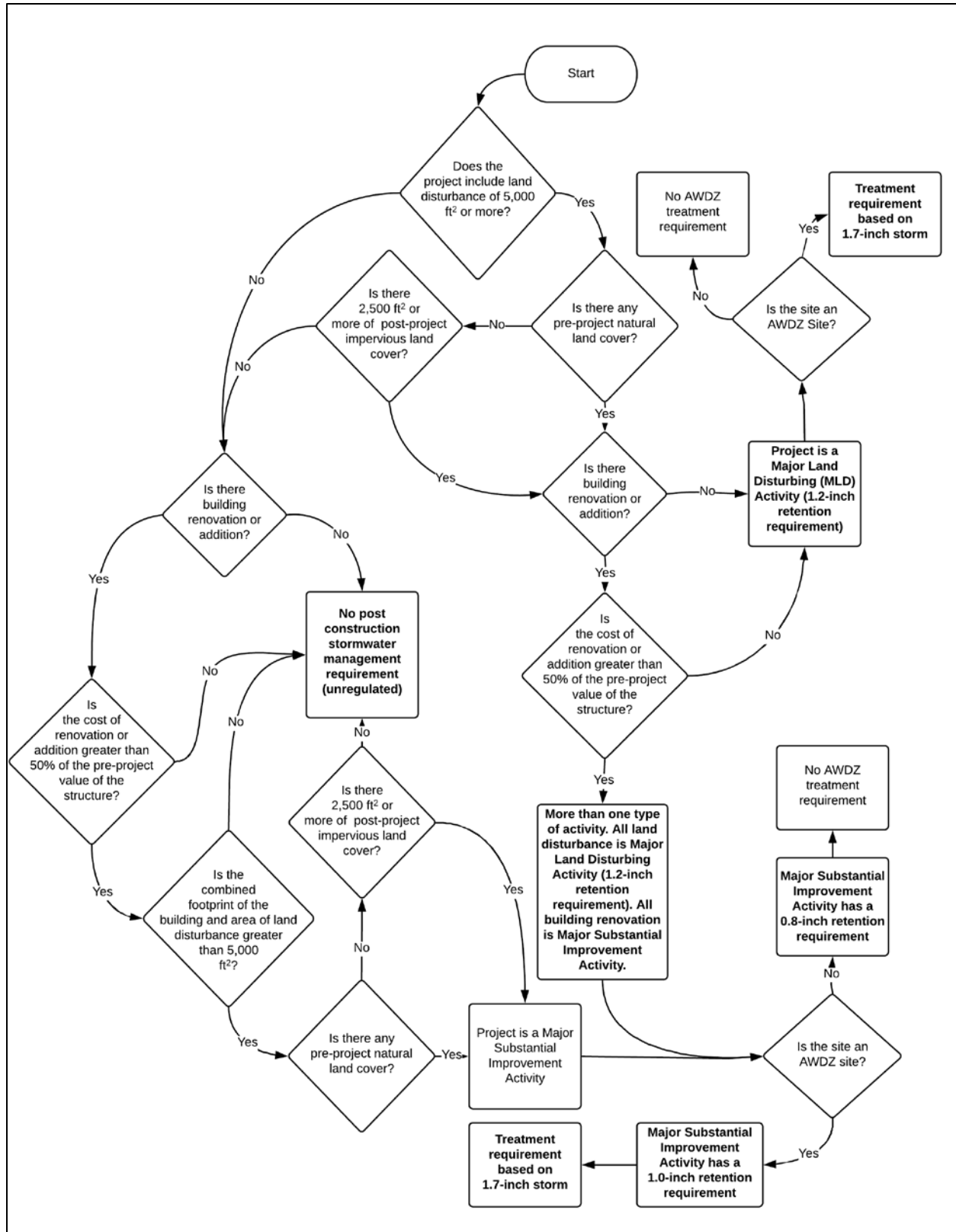


Figure 2.3 Determining the regulatory event used to calculate the SWRv.

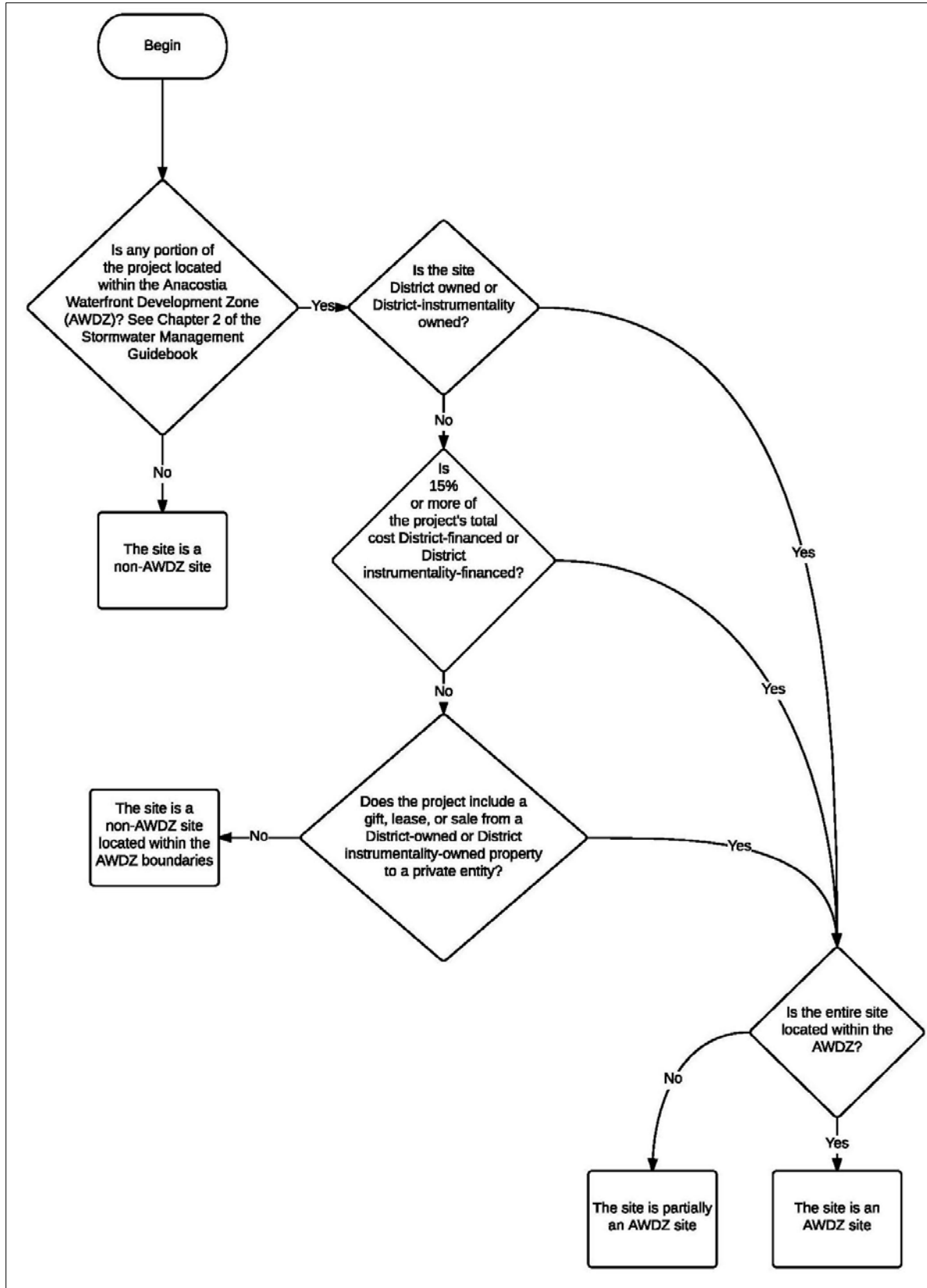


Figure 2.4 Determining if the site is an AWDZ site.

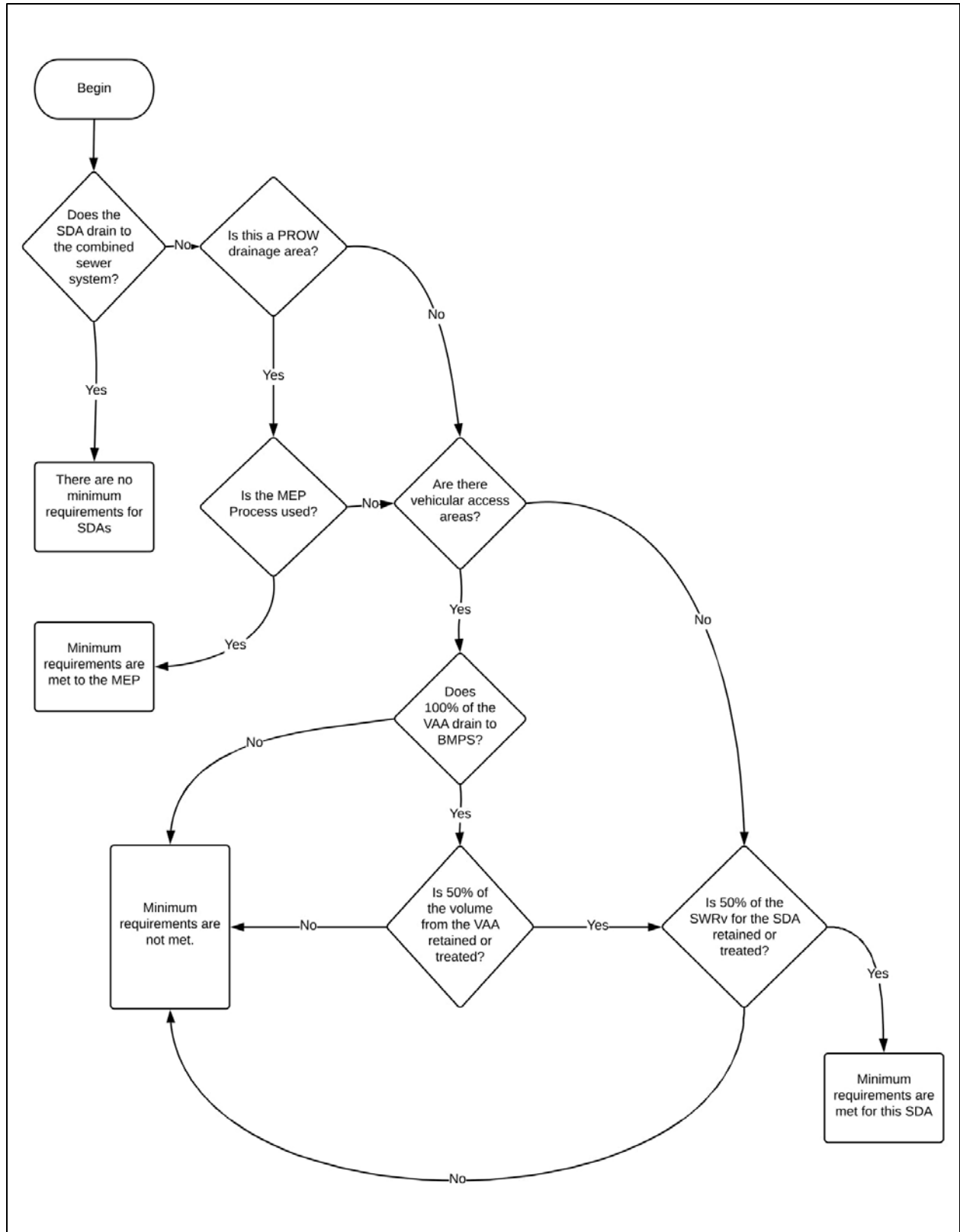


Figure 2.5 Determining if the minimum SDA requirements have been met.

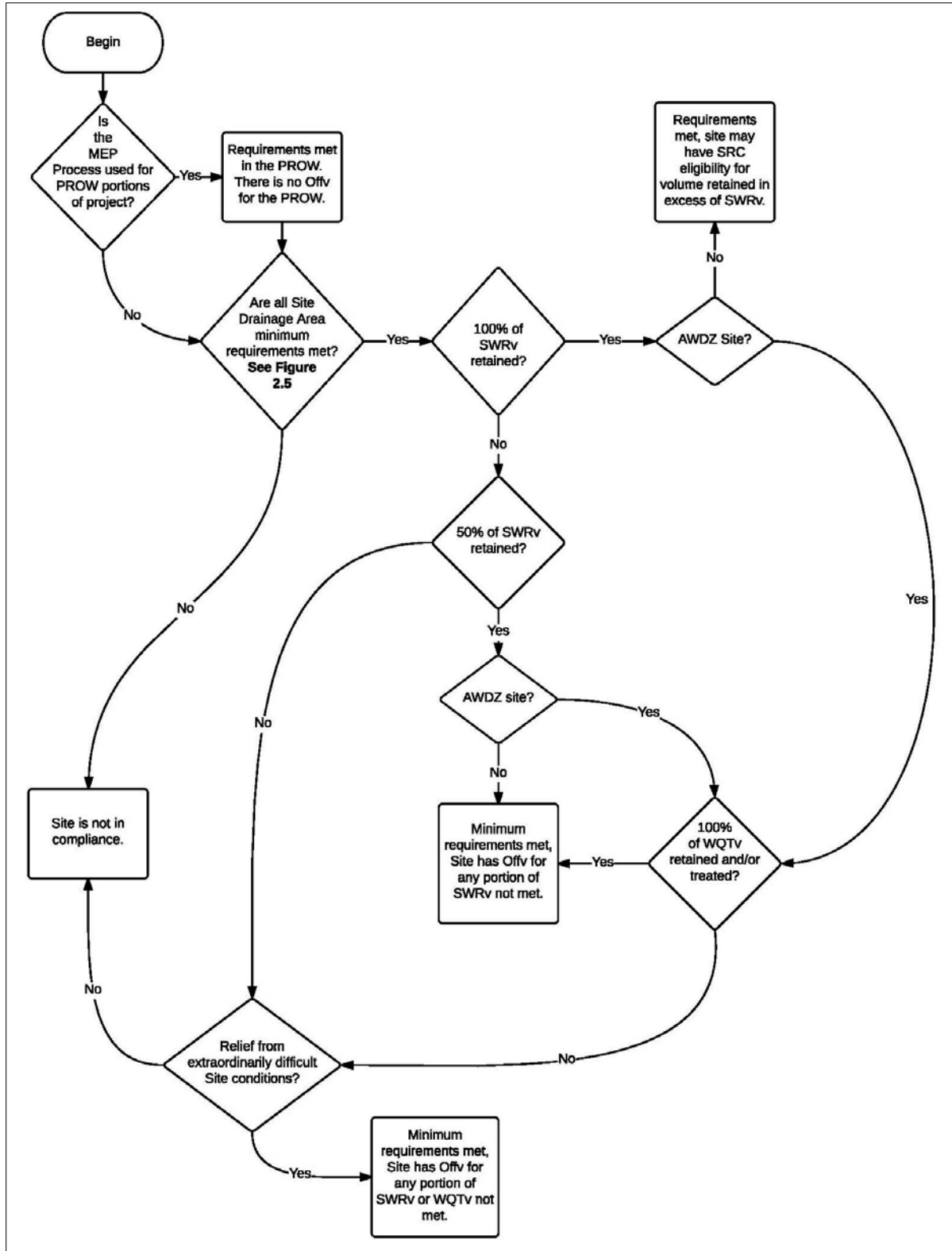


Figure 2.6 Determining if minimum retention and water quality treatment requirements have been met.

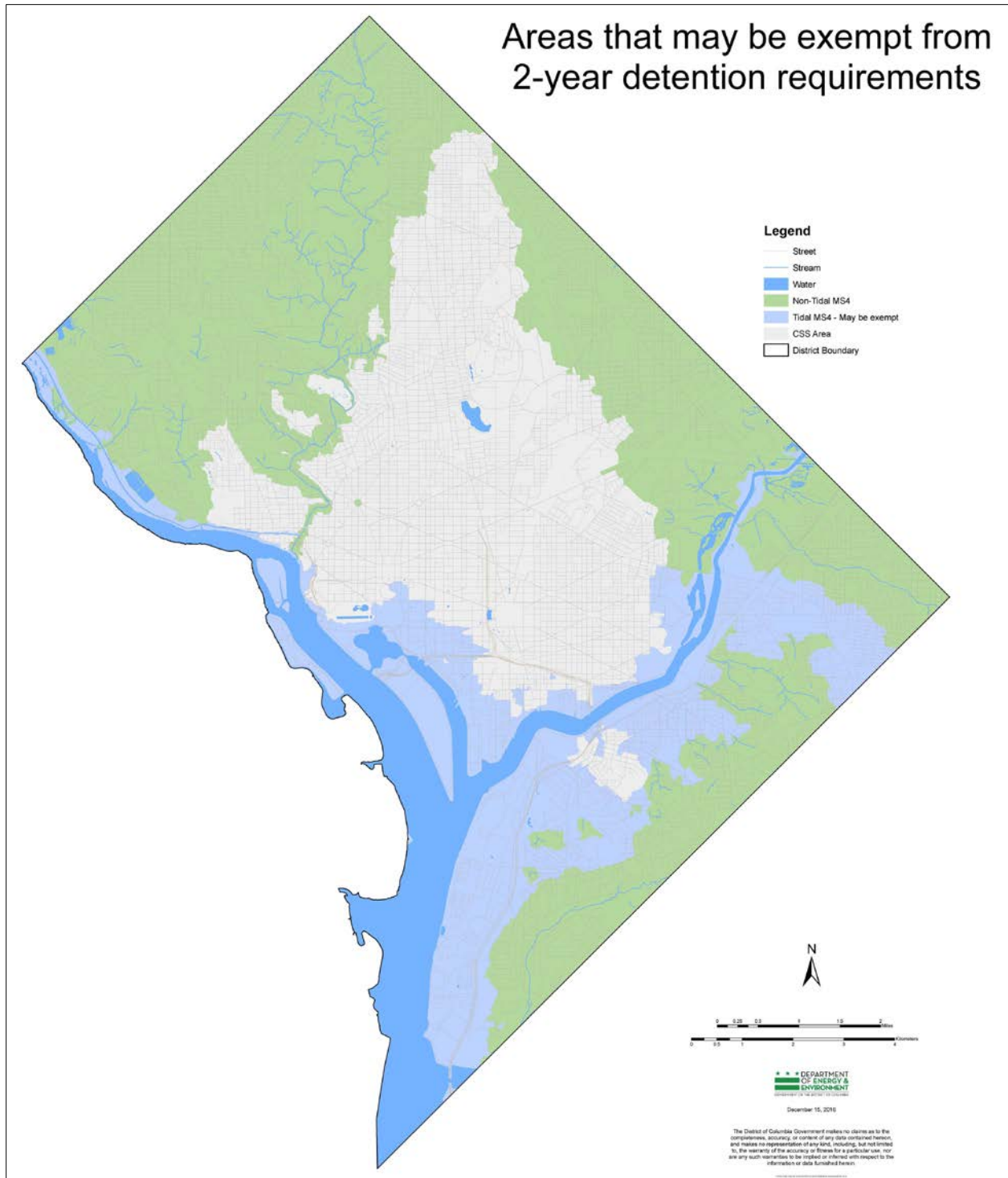
## 2.6 Control of 2-Year Storm

For most sites, detention must be provided on site to ensure the post-project peak discharge rate from the 2-year, 24-hour storm event is reduced to the predevelopment peak discharge rate for the site as a whole. Predevelopment conditions are defined hydrologically as “meadow in good condition.” Detention can be provided by the use of underground or surface storage practices or by increasing the size of BMPs used to meet SWRV requirements. Appendix A - Compliance Calculations and Design Examples includes more information about using the General Retention Compliance Calculator and Stormwater Database to account for retention BMPs when calculating detention requirements, and Appendix I - Acceptable Hydrologic Methods and Models includes further details and guidance for hydrologic computations.

Detention for the 2-year storm is not required for the following scenarios:

1. Major substantial improvement projects;
2. Projects that consist of reconstruction of the existing PROW; or
3. Projects for which stormwater runoff from the site:
  - a. Flows directly or through the MS4 to:
    - i. The main stem of the tidal Potomac or Anacostia Rivers;
    - ii. The Washington Channel; or
    - iii. The Chesapeake and Ohio Canal (C&O);
  - b. Does not flow through an above ground tributary (or through tributaries that DOEE expects to be daylighted in the future); and
  - c. Will not cause erosion of land or transport of sediment

Figure 2.7 illustrates the MS4 areas that may be exempt from the 2-year detention requirement. An interactive map of these areas is provided in the Stormwater Database. If DOEE is aware of a tributary that is expected to be daylighted in the future, the applicant will be notified.



**Figure 2.7 Map of drainage types in the District. The Tidal MS4 areas in light blue may be exempt from 2-year detention requirements.**

## 2.7 Control of 15-Year Storm

Detention must be provided on site to ensure the post-project peak discharge rate from the 15-year, 24-hour storm event is reduced to the pre-project peak discharge rate from the site as a whole (excluding the PROW areas). Pre-project conditions are defined as the conditions and land covers that existed on the site prior to construction. Detention can be provided using underground or surface storage practices, or by increasing the size of BMPs used to meet SWRV requirements. Appendix A - Compliance Calculations and Design Examples includes more information about using the General Retention Compliance Calculator and Stormwater Database to account for retention BMPs in calculating detention requirements. Appendix I - - Acceptable Hydrologic Methods and Models includes further details and guidance for hydrologic computations.

Detention for the 15-year storm is not required for major substantial improvement projects or project areas in the existing PROW.

## 2.8 Extreme Flood Requirements

To meet the extreme flood ( $Q_f$ ) requirements, a site shall maintain the post-project peak discharge rate from the 100-year storm event controlled to the pre-project peak discharge rate if the site meets one of the following:

1. Increases the size of a Special Flood Hazard Area (SFHA) as delineated on the effective Flood Insurance Rate Map (FIRM) or
2. Meets the following two conditions:
  - (a) Does not discharge to the sewer system and
  - (b) Has a post-development peak discharge rate for a 100-year-frequency storm event that will cause flooding to a building.

The intent of the extreme flood requirements is to (a) prevent flood damage from large storm events and (b) maintain the boundaries of the 100-year Federal Emergency Management Agency (FEMA) floodplain.

In general, stormwater runoff leaving a development site shall be discharged directly into an adequate natural or man-made receiving channel, pipe, or storm sewer system, or the applicant shall provide a drainage system satisfactory to DOEE to preclude an adverse impact (e.g., soil erosion, sedimentation, flooding, excessive duration of ponded water, inadequate overland relief) on downstream properties and receiving systems. If the applicant chooses to install a drainage system, the system shall be designed in accordance with established, applicable criteria for such systems.

Stormwater runoff leaving a development site where it does not discharge directly to the sewer system shall not aggravate or create a condition where an existing building is flooded from the 100-year storm event. If such a condition exists, on-site detention for the 100-year storm event shall be provided.



In situations where the size of the SFHA, as delineated on the effective FIRM by FEMA, will be increased based on the increased post-development 100-year discharge, the post-development 100-year peak discharge shall be maintained at a level that is equal to or less than the pre-project 100-year peak discharge.

## **2.9 Minimum Criteria for Determining Extreme Flood Requirements**

It is recommended that applicants use the District's online Flood Zone Determination Tool (available at <https://doee.dc.gov/floodplainmap>) as an initial screening for this section.

Applicants shall use the following minimum criteria to determine whether extreme flood requirements are applicable.

### **Downstream Analysis**

1. Consult DOEE to determine whether the downstream analysis is needed. A site visit may be necessary for the determination. This analysis is used to determine the impact of the 100-year post-development discharge on a building.
2. If the analysis is needed, the analysis shall contain supporting computations as justification for the conclusions contained in the analysis. For consistency, the following items are to be included, at a minimum:
  - (a) Site-specific narrative with a description of the elements of the storm drainage system, overland relief paths, and adjoining properties;
  - (b) A drainage plan showing outfall location(s) with the contributing drainage areas (CDAs) for each outfall, accompanied by digital photos of the outfall;
  - (c) A profile for each outfall channel and overland relief path;
  - (d) Two cross sections, at a minimum, at each critical location to verify the outfall and overland relief adequacy. Cross sections shall be based on a 2-foot contour interval and additional spot elevations in the vicinity. The cross sections shall have the same vertical and horizontal scales and shall identify the top of banks for the channel;
  - (e) Description of the outfall channel and permissible velocity. The Manning's roughness coefficient shall be supported by soil classification, cover material, and channel's or flow path's lining. The description of physical characteristics may include the amount of flow meandering, material classification of the flow path and its banks, vegetation, obstruction to flow, variations in cross sections, and surface irregularity;
  - (f) Detailed hydrologic and hydraulic (H&H) calculations to obtain the 100-year water surface elevation (WSE). The acceptable methodologies and models are specified in Appendix I - - Acceptable Hydrologic Methods and Models;
  - (g) Delineation of the 100-year WSE on the project drainage plan to show the location and approximate extent of the overland relief path and areas that may be affected by the surface storage for the 100-year storm event. Overlaying arrows, shading, or other suitable transparent graphics are suggested for this purpose; and

- (h) Certification by a District professional engineer that no buildings will be subject to increased flooding by the 100-year post-development discharge from the development site.
3. If buildings will be flooded based on the analysis, then the design engineer must perform more precise H&H computations. In addition to the on-site 100-year detention, the applicant shall design the outfall drainage system, overland relief swales, and/or surface storage in such a way that no building will be damaged by flooding.
  4. If the protection measures for the outfall drainage system or overland relief path are provided, necessary design details shall be shown and supported by calculations and submitted to DOEE for review.

### **Hydrologic and Hydraulic Analysis**

1. Consult DOEE to determine whether an H&H analysis is needed. If an H&H analysis is needed, the best available information, including topographic and structure data and modeling shall be used. This analysis is used to determine the impact on SFHA by considering the entire watershed or stream.
2. The acceptable methodologies and models for H&H analysis are specified in Section 2.10, “Hydrology Methods” and further described in Appendix I - - Acceptable Hydrologic Methods and Models.
3. H&H investigations may be required to demonstrate that upstream or downstream roads, bridges, and public utilities are adequately protected from the  $Q_f$  storm. These investigations typically extend to the first downstream tributary of equal or greater drainage area or to any downstream dam, highway, or natural point of restricted stream flow.

## **2.10 Hydrology Methods**

The following are the acceptable methodologies and computer models for estimating runoff hydrographs before and after development:

- Urban Hydrology for Small Watersheds TR-55
- Storage-Indication Routing
- HEC-HMS, WinTR-55, TR-20, and SWMM Computer Models
- Rational Method (limited to sites under 5 acres)

These methods are used to predict the runoff response from given rainfall information and site surface characteristic conditions. The design storm frequencies used in all of the hydrologic engineering calculations will be based on design storms required in this guidebook unless circumstances make consideration of another storm intensity criterion appropriate. These methods are given as valid in principle and are applicable to most stormwater management design situations in the District. Other methods may be used as approved by DOEE.

Note: Of the above methods, TR-55 and SWMM allow for the easiest correlation of the benefits of retention BMPs used to meet the SWRV with peak flow detention requirements and are

therefore strongly recommended. The Rational Method is not recommended because it cannot account for the detention benefits of smaller retention BMPs applied on a site. However, the Rational Method is useful for quickly and easily calculating peak flows and detention requirements.

## **2.11 Additional Stormwater Management Requirements**

Any BMP that may receive stormwater runoff from hotspot areas that are potential sources of oil and grease contamination (concentrations exceeding 10 milligrams per liter) shall include a baffle, skimmer, oil separator, grease trap, or other mechanism that prevents oil and grease from escaping the BMP in concentrations exceeding 10 milligrams per liter. These stormwater hotspot areas (sources of oil and grease contamination) are identified in Appendix Q - Stormwater Hotspots.

Any BMP that receives stormwater runoff from areas used to confine animals may be required to connect to a sanitary or combined sewer and to meet DC Water's pretreatment requirements.

In an area along a water body that runs above ground, a 25-foot buffer must be established in which the land immediately adjacent to the waterbody is not disturbed, except to restore native vegetation, and/or by planting vegetation or installing other measures required by DOEE to ensure that the buffer acts as a filter to trap sediment. DOEE may approve an exception to or modification of this requirement if the land disturbance in the buffer is required to construct, install, or repair a public trail, public access point, stormwater outfall, or utility line, or if the disturbance is required to enable development of the rest of the site and is done in a manner that is similar to the rest of the proposed project. In addition, the exception can only be approved if one of the following conditions is met:

1. Retention is provided for a 1.7-inch rainfall event for the disturbed area within the buffer by either directly treating the disturbed area within the buffer or by achieving the required 1.7-inch rainfall event retention for this area in another location within the same contributing drainage area;
2. The project receives relief from extraordinarily difficult site conditions for a portion of the 1.7-inch retention requirement and achieves the treatment and off-site retention requirements for the volume of relief granted; or
3. DOEE grants relief for a portion of the 1.7-inch retention requirement because on-site treatment is not feasible, and DOEE approves alternatives to on-site treatment that will help to protect or restore the waterbody.

## **2.12 Exemptions**

### **2.12.1 Detention for Major Substantial Improvement**

A major substantial improvement activity is exempt from the 2-year and 15-year storm-control requirements.

### **2.12.2 Disturbance for BMP Installation**

DOEE may determine that a land-disturbing activity is exempt from stormwater management performance requirements for major regulated projects, as well as requirements for covenants and easements, if the land-disturbing activity is conducted solely to install a BMP for the following reasons:

1. To generate a SRC as described in Chapter 7, “Generation, Certification, Trading, and Retirement of Stormwater Retention Credits,” of this guidebook;
2. To earn a stormwater fee discount through RiverSmart Rewards;
3. To voluntarily reduce stormwater runoff in a manner that would be eligible to either generate SRCs or a stormwater fee discount, even if the person conducting the activity does not intend to apply to either program;
4. To provide for off-site retention through in-lieu fee payments;
5. To comply with a Watershed Implementation Plan established under a Total Maximum Daily Load for the Chesapeake Bay; or
6. To reduce CSOs in compliance with a court-approved consent decree, including court-approved modifications, or in compliance with a National Pollutant Discharge Elimination System permit.

Note: While SWMP approval of these projects does not require a declaration of covenants or easements, the applicant must provide an executed maintenance contract or a signed promise to follow the DOEE-approved maintenance plan for the period of time for which the certification of SRCs is requested. If the site fails to maintain these retention practices, DOEE has recourse that is spelled out in Chapter 5, “Administration of Stormwater Management Rules,” and Chapter 7, “Generation, Certification, Trading, and Retirement of Stormwater Retention Credits,” of this guidebook.

### **2.12.3 Athletic Playing Fields, Permeable Athletic Tracks, and Permeable Playground Surfaces**

The portion of the land-disturbing activity that consists of installation or replacement of athletic playing fields, permeable athletic tracks, or permeable playground surfaces is exempt from the stormwater management requirements, provided the following conditions are met:

1. Pre-project land disturbance is compacted cover or impervious cover;
2. The surface is located at a school or public park and is made available for use by the general public; and
3. The activity achieves the 2- and 15-year post-development peak discharge requirements for major land-disturbing activities.

If these surfaces include an underdrain, the project must be designed with a stone reservoir at least 6 inches deep. Additionally, runoff volume from the 1.2” storm must be captured in the reservoir layer and detained between 36 to 48 hours before completely discharging through the underdrain. The minimum orifice size is 1 inch regardless of the calculated drawdown time. Table 2.2 indicates typical orifice sizes that may be used to meet these requirements. Information

on the stone reservoir layer and chosen orifice sizing should be submitted with the erosion and sediment control plan set.

**Table 2.2 Typical Orifice Sizes for Drainage of Artificial Turf Fields**

Artificial Turf Field Area (ft <sup>2</sup> )	Underdrain Orifice Diameter (in)
≤ 15,000	1
15,001 – 23,000	1.25
23,001 – 32,000	1.5
32,001 – 40,000	1.75
40,001 – 49,000	2
49,001 – 58,000	2.25
58,001 – 77,000	2.5
77,001 – 100,000	3

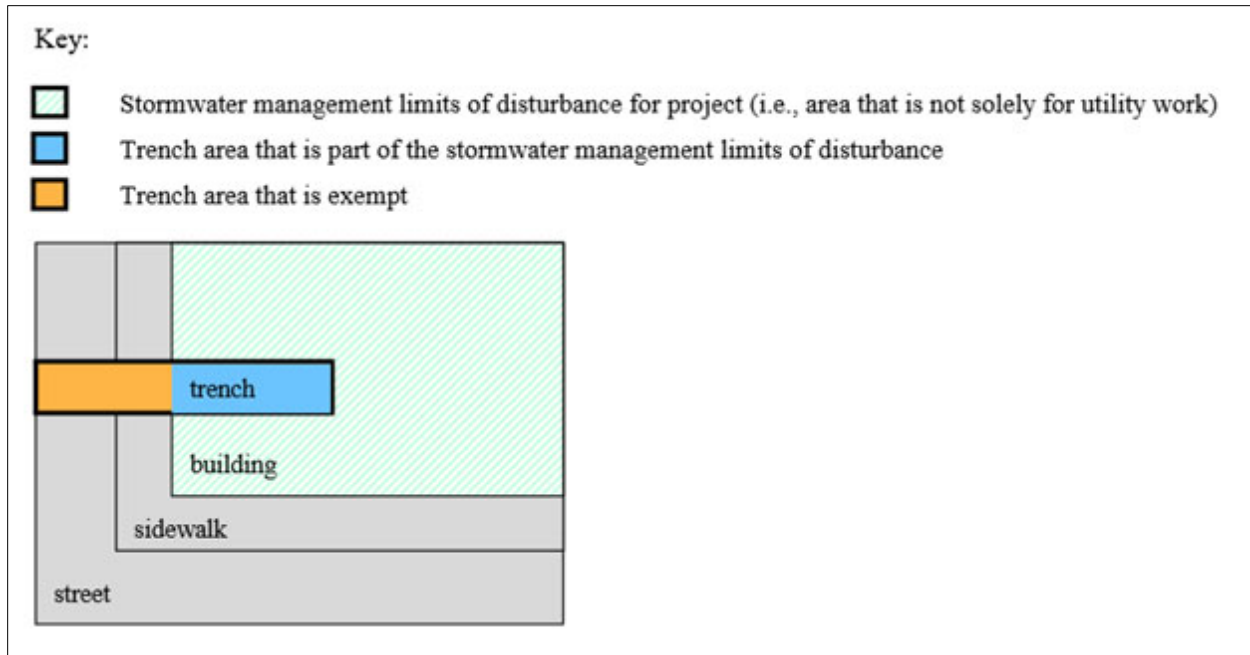
For previously-approved projects with an Offv that fall under this exemption, DOEE may approve the elimination of the Offv obligation. Any on-site BMP that was previously constructed must continue to be maintained.

#### 2.12.4 Utility Work

Land-disturbing activities that consist solely of cutting a trench for utility work and related replacement of sidewalks and ramps are exempt from stormwater management requirements if the activity does not involve the reconstruction of a roadway from curb to curb or curb to centerline of roadway. This exemption applies equally to public and private space. However, the area of a utility trench that is located within the footprint of other land-disturbing activity is considered part of the limits of disturbance that must meet stormwater management requirements and is not exempt.

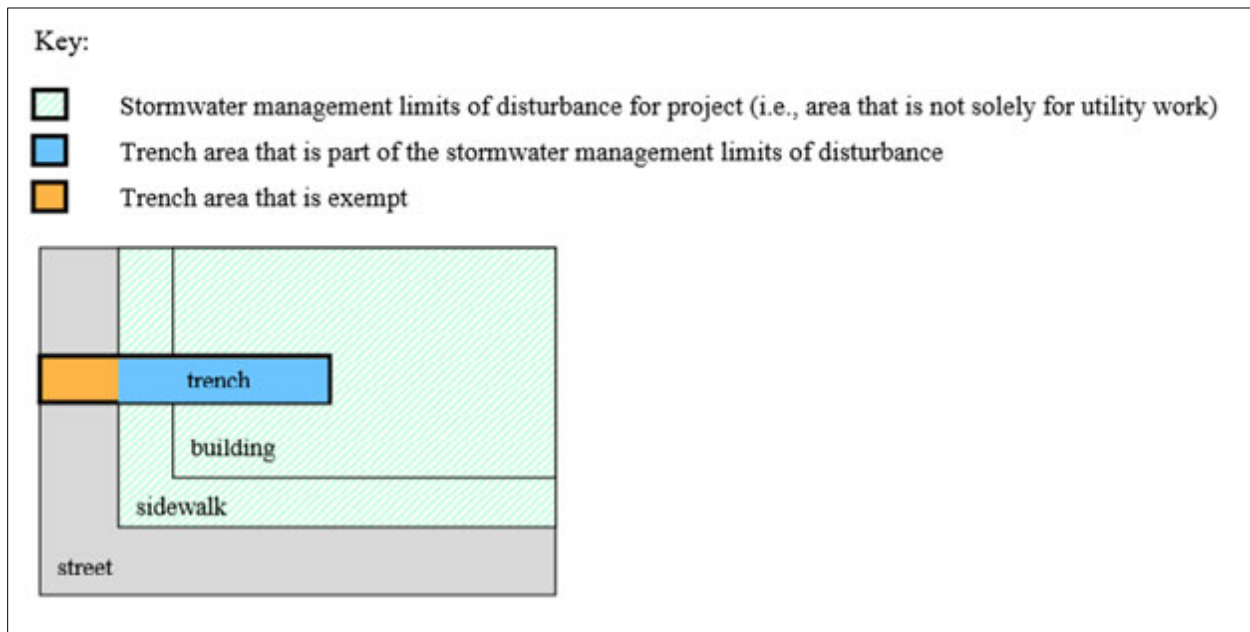
The following are some examples of utility trench areas that are part of the limits of disturbance that must meet stormwater management requirements.

Figure 2.8 shows the portion of a utility trench under a building or other disturbed area that is being constructed or replaced.



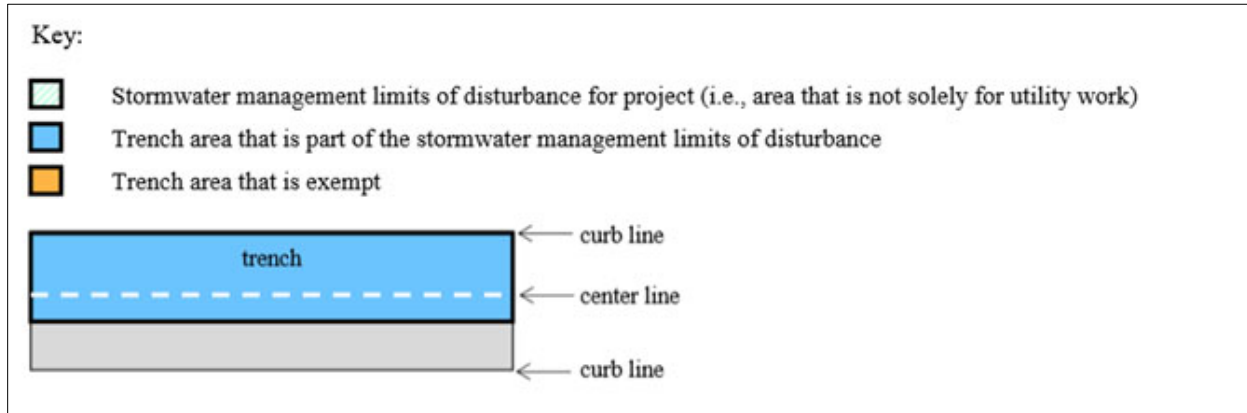
**Figure 2.8 Utility trench exemption example with building in LOD.**

Figure 2.9 shows the portion of a utility trench under a sidewalk or driveway that is being constructed or replaced for purposes other than utility work.



**Figure 2.9 Utility trench exemption example with building and sidewalk in LOD.**

Figure 2.10 shows utility trenches for utility work that requires road reconstruction from curb to curb or from the curb to the centerline of the roadway.



**Figure 2.10 Utility trench exemption example solely for utility work.**

Note: Most land disturbance over 50 square feet for a utility trench is required to comply with soil erosion and sediment control requirements. See 21 DCMR, Chapter 5 for more details.

Land-disturbing activities conducted solely to respond to an emergency need to protect life, limb, or property or to conduct emergency repairs are exempt from most stormwater management requirements. These activities are not required to submit an SWMP, but they are subject to inspections to ensure the proper use of soil erosion and sediment control measures.

## 2.13 Practicable Process

The term practicable in the context of the District's stormwater management requirements means that the project can demonstrate a reasonable effort has been made to retain runoff from the project area on-site. Some projects are allowed to follow the Practicable Process (described in Appendix C) to meet some or all of their stormwater management requirements. These projects may be approved without fully achieving the SWRV and, in most cases, will not have an Offv assigned to them. Project types and the conditions for being allowed under the Practicable Process follow.

### 2.13.1 Affordable Housing

The construction of single-family or two-family affordable houses can be approved using the Practicable Process provided that each of the following conditions are satisfied:

1. The land-disturbing activity is less than 5,000 square feet on any single record lot or tax lot for which the applicant seeks consideration under the Practicable Process. This includes common plans of development for which the total disturbance is greater than 5,000 square feet, but disturbance on each single lot is less than 5,000 square feet;
2. The house is owner-occupied; and

3. Within 30 days of sale of the house, the purchaser provides proof to DOEE that the purchaser's household income is no greater than 80% of the area median income.

These projects, if approved under the Practicable Process, will have an Offv associated with them, but the Offv will be waived provided that the owner meets the income requirement. DOEE may require full compliance with the stormwater management performance requirements if the owner fails to provide proof that the income is met. The Offv and income requirement shall be recorded in the Stormwater Covenant for the property.

For previously-approved single-family and two-family affordable houses with Offv, DOEE may approve the elimination of the Offv obligation. However, any on-site BMP that was previously constructed must continue to be maintained.

### **2.13.2 Trails**

Projects consisting solely of trails for pedestrians or non-motorized vehicles are allowable under the Practicable Process, provided the following conditions are satisfied:

1. These projects do not consist of the reconstruction of a roadway and its adjacent sidewalks; and
2. There is no pre-project natural land cover.

These projects, if approved under the Practicable Process, will have no Offv associated with them.

### **2.13.3 Small Structures at Parks**

Projects consisting solely of the construction of pavilions, sheds, dugouts, or similar structures are allowable under the Practicable Process, provided the following conditions are satisfied:

1. The project is located at a public park;
2. The structures are less than 2,500 ft<sup>2</sup> each;
3. The structures do not include typical building infrastructure to support year-round use; and
4. There is no pre-project natural land cover.

These projects, if approved under the Practicable Process, will have no Offv associated with them.



# Chapter 3                      Stormwater Best Management Practices (BMPs)

## 3.1    Standard Stormwater Best Management Practice Design Guidance Format

This chapter outlines performance criteria for 13 stormwater best management practice (BMP) categories that include green roofs, rainwater harvesting, impervious surface disconnection, permeable pavement, bioretention, filtering systems, infiltration, open channels, ponds, stormwater wetlands, storage practices, proprietary practices, and tree planting and preservation.

BMP performance criteria are based on several critical design factors to ensure effective and long-lived BMPs. Design components that differ from these specifications but meet their intent may be included at the Department of Energy and Environment’s (DOEE’s) discretion. In this chapter, and throughout the guidebook, the terms “must” or “shall” denote required aspects of BMPs or their design and implementation, while the term “should” denotes a recommendation. However, justification may be necessary for design or implementation that does not correspond to certain recommendations.

For each BMP, the following factors are discussed:

- General Feasibility
- Conveyance
- Pretreatment
- Design and Sizing
- Landscaping
- Construction Sequencing
- Maintenance
- Stormwater Compliance Calculations



---

## 3.2 Green Roofs

**Definition.** Practices that capture and store rainfall in an engineered growing media installed over a waterproof membrane that is designed to support plant growth on the roof of a building or other structure. A portion of the captured rainfall evaporates or is taken up by plants, which helps reduce runoff volumes, peak runoff rates, and pollutant loads on development sites. Green roofs typically contain a layered system of roofing, which is designed to support plant growth and retain water for plant uptake while preventing ponding on the roof surface. The roofs are designed so that water drains vertically through the media and then horizontally along a waterproofing layer towards the outlet. Plant species are selected so that the roof requires minimal, infrequent fertilization after vegetation is initially established.

Design variants include extensive and intensive green roofs.

- G-1 Extensive green roofs have a much shallower growing media layer that typically ranges from 3 to 8 inches thick and are designed to have minimal maintenance requirements.
- G-2 Intensive green roofs have a growing media layer that typically ranges from 8 to 48 inches thick.

Green roofs are typically not designed to provide stormwater detention of larger storms (e.g., 2-year, 15-year) although some intensive green roof systems may be designed to meet these criteria. Most green roof designs shall generally be combined with a separate facility to provide large storm controls.

This specification is intended for situations where the primary design objective of the green roof is stormwater management and, unless specified otherwise, addresses the design of extensive roof systems. While rooftop practices such as urban agriculture may provide some retention, their primary design objective is not stormwater management and is not addressed in this specification.

### 3.2.1 Green Roof Feasibility Criteria

Green roofs are ideal for use on commercial, institutional, municipal, and multi-family residential buildings. They are particularly well-suited for use on ultra-urban development and redevelopment sites. Key constraints with green roofs include the following:

**Structural Capacity of the Roof.** When designing a green roof, designers must not only consider the stormwater storage capacity of the green roof but also its structural capacity to support the weight of the additional water. A conventional rooftop should typically be designed to support an additional 15 to 30 pounds per square foot (psf) for an extensive green roof. As a result, a structural engineer or architect should be involved with all green roof designs to ensure that the building has enough structural capacity to support a green roof. For a discussion of green roof structural design issues, consult Chapter 9 in Weiler and Scholz-Barth, “Green Roof Systems” (2009), and ASTM International Standard ASTM E2397/E2397M-15, “Standard Practice for Determination of Dead Loads and Live Loads Associated with Vegetative (Green) Roof Systems” (2015).

**Roof Pitch.** Green roof storage volume is maximized on relatively flat roofs (a pitch of 1% to 2%). Some pitch is needed to promote positive drainage and prevent ponding and/or saturation of the growing media. Green roofs can be installed on rooftops with slopes up to 30% if baffles, grids, or strips are used to prevent slippage of the media. These baffles must be designed to ensure the roof provides adequate storage for the design storm. Slopes greater than 30% would be considered a green wall, which is not specifically identified as a stormwater BMP. Green walls can be used to receive cistern discharge (calculations are necessary to determine demand) and can be used to comply with Green Area Ratio Requirements.

**Roof Access.** Adequate access to the roof must be available to deliver construction materials and perform routine maintenance and inspections. Roof access can be achieved either by an interior stairway through a penthouse or by a window or hatch not less than 16 square feet in area, with the smallest dimension being not less than 24 inches). Designers should also consider how they will get construction materials up to the roof (e.g., by elevator or crane) and how the roof structure can accommodate material stockpiles and equipment loads. If material and equipment storage is required, rooftop storage areas must be identified and clearly marked based on structural load capacity of the roof. For heights up to 10 feet, a temporary ladder is sufficient for access from the level below. The ladder must be at least 3 feet longer than the height of the wall. When access is through private tenant spaces, language allowing for access through the appropriate spaces must be included in the SWMP maintenance plan and in the declaration of covenants.

**Roof Type.** Green roofs can be applied to most roof surfaces. Certain roof materials, such as exposed treated wood and uncoated galvanized metal, may not be appropriate for green rooftops due to pollutant leaching through the media (Clark et al., 2008).

**Setbacks.** Green roofs should not be located near rooftop electrical and heating, ventilation and air conditioning (HVAC) systems. This setback requirement for raised HVAC systems is waived if the system complies with the minimum design specifications outlined in Section 3.2.4, subsection “Solar Panels and Other Structures.” A 2-foot-wide vegetation-free zone is recommended along the perimeter of the roof with a 1-foot vegetation-free zone around all roof penetrations. The 2-foot setback may be relaxed for small or low green roof applications where parapets have been properly designed.

**Contributing Drainage Area.** It is recommended that the contributing drainage area (CDA) to a green roof be limited to the green roof itself. When there will be additional CDA, the designer must provide sufficient design detail showing distribution of this additional runoff throughout the green roof area to prevent erosion or overloading of the roof growing media with the use of level spreaders, splash pads, perforated piping, or other flow dissipation techniques. The absolute maximum CDA that can be assigned to a green roof shall be no more than 100% larger than the area of the green roof (e.g., a 1,000-square-foot green roof can have no more than 1,000 square feet of additional impervious CDA assigned to it). In some roof designs, a larger area may actually flow to the green roof, but the retention value calculations cannot utilize a CDA with more than a 1:1 ratio of impervious area to green roof.

**District Building Codes.** The green roof design must comply with the District’s building codes with respect to roof drains and emergency overflow devices. Regarding wind design and fire codes, the District has adopted the following building code standards:

- ANSI/SPRI VF-1 External Fire Design Standard for Vegetative Roofs (2017)
- ANSI/SPRI RP-14 Wind Design Standard for Vegetative Roofing Systems (2016)

Additionally, a District of Columbia registered structural engineer must certify that the design complies with District building structural codes. This is true for new construction as well as retrofit projects.

### **3.2.2 Green Roof Conveyance Criteria**

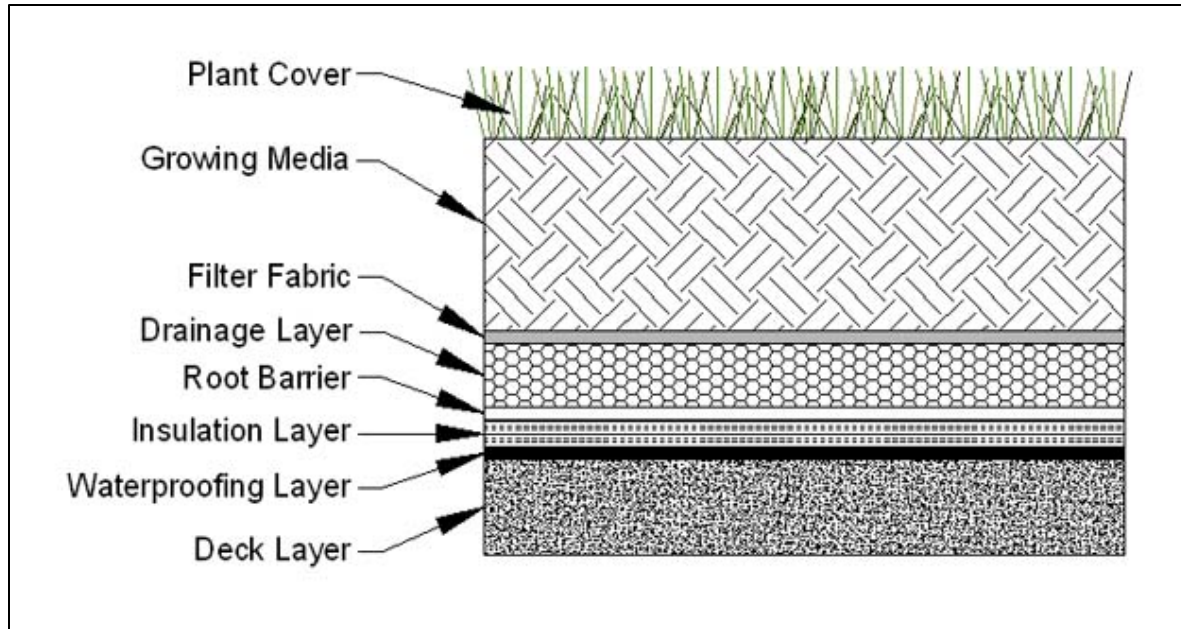
The green roof drainage layer (refer to Section 3.2.4, “Green Roof Design Criteria”) must convey flow from under the growing media directly to an outlet or overflow system such as a traditional rooftop downspout drainage system. The green roof drainage layer must be adequate to convey the volume of stormwater equal to the flow capacity of the overflow or downspout system without backing water up onto the rooftop or into the green roof media. Roof drains immediately adjacent to the growing media should be boxed and protected by flashing extending at least 3 inches above the growing media to prevent clogging. However, an adequate number of roof drains that are not immediately adjacent to the growing media must be provided so as to allow the roof to drain without 3 inches of ponding above the growing media.

### **3.2.3 Green Roof Pretreatment Criteria**

Pretreatment is not necessary for green roofs.

### **3.2.4 Green Roof Design Criteria**

**Functional Elements of a Green Roof System.** A green roof is composed of up to nine different systems or layers that combine to protect the roof and maintain a vigorous cover (see Figure 3.1).



**Figure 3.1 Typical layers for a green roof. Note: the relative placement of various layers may vary depending on the type and design of the green roof system.**

The design layers include the following:

- 1. Deck Layer.** The roof deck layer is the foundation of a green roof. It may be composed of concrete, wood, metal, plastic, gypsum, or a composite material, and must comply with the District of Columbia Construction Codes. The type of deck material determines the strength, load bearing capacity, longevity, and potential need for insulation in the green roof system.
- 2. Leak Detection System (optional).** Leak detection systems are often installed above the deck layer to identify leaks, minimize leak damage through timely detection, and locate leak locations. Electronic leak detection techniques are strongly recommended as part of the green roof installation process. The deck material must be conductive for electronic leak detection. If it is not, an additional conductive medium may need to be added on top of the deck. Other leak detection systems may require additional materials between the deck layer and the waterproofing layer.
- 3. Waterproofing Layer.** All green roof systems must include an effective and reliable waterproofing layer to prevent water damage through the deck layer. A wide range of waterproofing materials can be used, including hot applied rubberized asphalt, built up bitumen, modified bitumen, thermoplastic membranes, polyvinyl chloride (PVC), thermoplastic olefin membrane (TPO), and elastomeric membranes (EPDM) (see Weiler and Scholz-Barth, and Snodgrass and Snodgrass (see section 3.2.9, “References.”)). The waterproofing layer must be 100% waterproof and have an expected life span as long as any other element of the green roof system. The waterproofing material may be loose laid or bonded (recommended). If loose laid, overlapping and additional construction techniques should be used to avoid water migration. All waterproofing layers must comply with the District of Columbia Construction Codes.

- 4. Insulation Layer.** Many green rooftops contain an insulation layer, usually located above, but sometimes below, the waterproofing layer. The insulation increases the energy efficiency of the building and/or protects the roof deck (particularly for metal roofs). According to Snodgrass and Snodgrass (2006), the trend is to install insulation on the outside of the building, in part to avoid mildew problems. The designer should consider the use of open or closed cell insulation depending on whether the insulation layer is above or below the waterproofing layer (and thus exposed to wetness), with closed cell insulation recommended for use above the waterproofing layer.
- 5. Root Barrier.** Another layer of a green roof system, which can be either above or below the insulation layer depending on the system, is a root barrier that protects the waterproofing membrane or insulation layer from root penetration. A wide range of root barrier options are described in Weiler and Scholz-Barth (2009). Chemical root barriers or physical root barriers that have been impregnated with pesticides, metals, or other chemicals that could leach into stormwater runoff must be avoided in systems where the root barrier layer will come in contact with water or allow water to pass through the barrier.
- 6. Drainage Layer and Drainage System.** A drainage layer is placed between the root barrier and the growing media to quickly remove excess water from the vegetation root zone. The selection and thickness of the drainage layer type is an important design decision that is governed by the desired stormwater storage capacity, the required conveyance capacity, and the structural capacity of the rooftop. The effective depth of the drainage layer is generally 0.25–1.5 inches thick for extensive green roof system and increases for intensive designs. The drainage layer should consist of synthetic or inorganic materials (e.g., 1 to 2-inch layer of granular material (ASTM D448 size No. 8 stone or lightweight granular mix) washed clean and free of fines, or high-density polyethylene (HDPE)) that is capable of retaining water and providing efficient drainage (ASTM, 2017). A wide range of prefabricated water cups or plastic modules can be used, as well as a traditional system of protected roof drains, conductors, and roof leaders. ASTM E2396 and E2398 can be used to evaluate alternative material specifications (ASTM, 2015).
- 7. Root-Permeable Filter Fabric.** A semi-permeable needled polypropylene filter fabric is normally placed between the drainage layer and the growing media to prevent the media from migrating into the drainage layer and clogging it. The filter fabric must not impede the downward migration of water into the drainage layer.
- 8. Growing Media.** The next layer in an extensive green roof is the growing media, which is typically 2 to 8 inches deep. The recommended growing media for extensive green roofs is typically composed of approximately 70% to 80%, by weight, lightweight inorganic materials, such as expanded slates, shales or clays; pumice; scoria; or other similar materials. The media must contain no more than 30% organic matter, normally well-aged compost (see Appendix K - Soil Compost Amendment Requirements). The percentage of organic matter should be limited since it can leach nutrients into the runoff from the roof and clog the permeable filter fabric. It is advisable to mix the media in a batch facility prior to delivery to the roof. Manufacturer’s specifications should be followed for all proprietary roof systems. More information on growing media can be found in Weiler and Scholz-Barth, and Snodgrass and Snodgrass (see Section 3.2.9, “References.”).

The composition of growing media for intensive green roofs may be different (although the organic material limit still applies), and it is often much greater in depth (e.g., 8–48 inches). If trees are included in the green roof planting plan, the growing media must be sufficient to provide enough soil volume for the root structure of mature trees.

- 9. Plant Cover.** The top layer of an extensive green roof typically consists of plants that are slow-growing, shallow-rooted, perennial, and succulent. These plants are chosen for their ability to withstand harsh conditions at the roof surface. Guidance on selecting the appropriate green roof plants can often be provided by green roof manufacturers and can also be found in Snodgrass and Snodgrass (see Section 3.2.9, “References.”). A mix of base ground covers (usually *Sedum* species) and accent plants can be used to enhance the visual amenity value of a green roof. See Section 3.2.4, “Green Roof Design Criteria,” for additional plant information. The design must provide for temporary, manual, and/or permanent irrigation or watering systems, depending on the green roof system and types of plants. For most applications, some type of watering system should be accessible for initial establishment or drought periods. The use of water efficient designs and/or use of non-potable sources are strongly encouraged.

**Material Specifications.** Standard specifications for North American green roofs continue to evolve, and no universal material specifications exist that cover the wide range of roof types and system components currently available. The ASTM has recently issued several overarching green roof standards, which are described and referenced in Table 3-1 below.

Designers and reviewers should also fully understand manufacturer specifications for each system component, particularly if they choose to install proprietary “complete” green roof systems or modules.



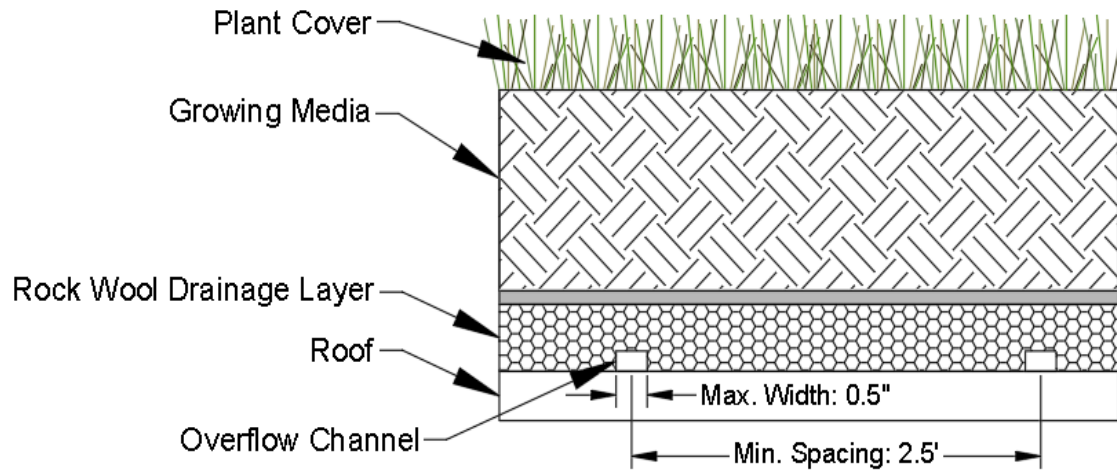
**Table 3-1 Extensive Green Roof Material Specifications**

Material	Specification
Roof	Structural capacity must conform to ASTM E2397. In addition, use standard test methods ASTM E2398 and ASTM E2399.
Leak Detection System	Optional system to detect and locate leaks in the waterproof membrane.
Waterproof Membrane	See Chapter 6 of Weiler and Scholz-Barth (2009) for waterproofing options that are designed to convey water horizontally across the roof surface to drains or gutter. This layer may sometimes act as a root barrier.
Root Barrier	Impermeable liner that impedes root penetration of the membrane.
Drainage Layer	Depth of the drainage layer is generally 0.25 to 1.5 inches thick for extensive designs. The drainage layer should consist of synthetic or inorganic materials (e.g., gravel, HDPE) that are capable of retaining water and providing efficient drainage. A wide range of prefabricated water cups or plastic modules can be used, as well as a traditional system of protected roof drains, conductors, and roof leaders. Designers should consult the material specifications as outlined in ASTM E2396 and E2398. Roof drains and emergency overflow must be designed in accordance with the District's construction code (Title 12 of the District of Columbia Municipal Regulations).
Filter Fabric	<p>Generally, needle-punched, nonwoven, polypropylene geotextile, with the following qualities:</p> <ul style="list-style-type: none"> <li>▪ Strong enough and adequate puncture resistance to withstand stresses of installing other layers of the green roof.</li> <li>▪ Adequate tensile strength and tear resistance for long-term performance.</li> <li>▪ Allows a good flow of water to the drainage layer. Apparent Opening Size, as per ASTM D4751, of greater than or equal to 0.06mm and less than or equal to 0.2mm.</li> <li>▪ Allows at least fine roots to penetrate.</li> <li>▪ Adequate resistance to soil borne chemicals or microbial growth both during construction and after completion since the fabric will be in contact with moisture and possibly fertilizer compounds.</li> </ul>
Growth Media	70% to 80% by weight of lightweight inorganic materials and a maximum of 30% organic matter (e.g., well-aged compost). Material makeup of the growing media must be provided. Media must provide sufficient nutrients and water holding capacity to support the proposed plant materials. Determine acceptable saturated water permeability using ASTM E2396. An acceptable emerging industry practice combines the drainage layer with the growing media layer.
Plant Materials	<i>Sedum</i> , herbaceous plants, and perennial grasses that are shallow-rooted, low maintenance, and tolerant of full and direct sunlight, drought, wind, and frost. See ASTM E2400, <i>Standard Guide for Selection, Installation, and Maintenance of Plants for Green Roof Systems</i> .

**Rock Wool and Contributing Drainage Area.** As stated in Section 3.2.1 above, in cases in which the green roof CDA extends beyond the green roof itself, the design must include sufficient distribution or dissipation of this additional runoff throughout the green roof. Typically, in order to provide sufficient distribution, the additional roof area must have a higher elevation than the green roof so that gravity flow will allow the runoff to reach the green roof. If rock wool is used as the drainage layer for the green roof, however, the additional CDA may be located at the same elevation as the base of the green roof.

Rock wool, also referred to as mineral wool, is a product that has begun to be incorporated as the drainage layer for green roofs as it absorbs water, but still allows excess water to drain. The unique absorptive properties of rock wool allow it to absorb runoff from an adjacent roof surface. Additional CDA to the green roof, therefore, does not need to be at a higher elevation than the green roof. The following caveats and requirements apply to using a rock wool or mineral wool drainage layer::

- No roof drains can be present in the additional contributing roof area, as they will provide a preferential flow path that bypasses the green roof.
- The rock wool drainage layer must be in direct contact with the roof membrane or protection fabric. Designs that include an air layer/drain board or that rely on “wicking tongues” to capture the additional CDA are not acceptable.
- Channels to facilitate overflow and eliminate rooftop flooding may be incorporated into the rock wool:
  - ◆ The maximum channel width is 0.5 inch. Water contact with the sides of the channel is essential to ensure complete capture of smaller storm events. Wider channels may allow too much bypass.
  - ◆ Perforated pipe and other designs that limit water contact with the rock wool on the sides of the channels are not acceptable.
  - ◆ Channels must be evenly distributed throughout the green roof and be spaced no closer than one channel every 2.5 feet.
  - ◆ The runoff flow path from the contributing roof area must be less than or equal to the length of the channels.



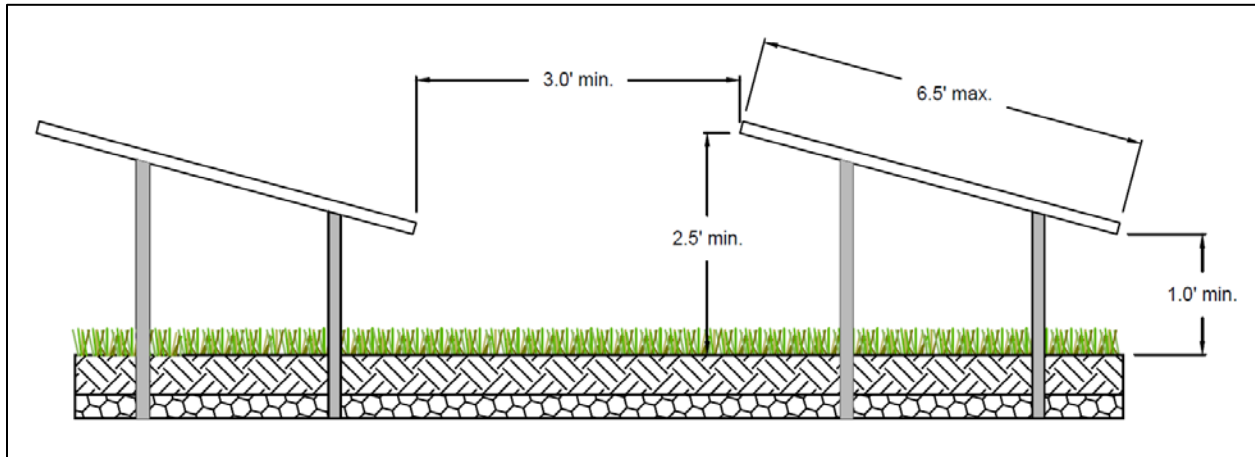
**Figure 3.2 Optional overflow channels for rock wool drainage layer.**

**Solar Panels and Other Structures.** Occasionally, structures such as solar panels or HVAC systems must be installed above a green roof. These structures can be incorporated into a green roof design with no adverse effects to the retention value assigned to the green roof if specific design requirements for runoff disbursement, maintenance access, and sun and wind exposure are incorporated, including the following:

- Structures above the green roof must be no more than 6.5 feet wide;
- Structures must have a minimum 3-foot separation between them; and
- The lower edge of the structure must be at least 1 foot above the top of the green roof, and the upper edge must be at least 2.5 feet above the top of the green roof. This allows for a tilt of at least a 15-degrees. For flatter installations, the lower edge would need to be raised to ensure that the 2.5-foot minimum elevation for the upper edge is met.

These design requirements only apply to solar panels or HVAC systems, not the conduits running to them. The conduits must be properly protected when placed on the green roof.

These design requirements are illustrated in Figure 3.3.



**Figure 3.3 Design requirements for structures constructed above green roofs.**

**Green Roof Sizing.** Green roof areas can be designed to capture the entire Stormwater Retention Volume (SWRV). In some cases, they could be designed to capture larger design storm volumes as well. The required size of a green roof will depend on several factors, including maximum water retention of the growing media and the underlying drainage and storage layer materials, if present (e.g., prefabricated water cups or plastic modules). As maximum water retention can vary significantly between green roof products, verification of this value must be included with the Stormwater Management Plan (SWMP). Verification shall be provided by an ASTM-certified lab using the methods described by ASTM tests E2396, E2397, E2398, or E2399, as appropriate. For green roof media, ASTM test E2399 specifies that a 4-inch thick layer be tested. For the drainage layer, the test performed must be representative of the actual thickness and depth of the drainage layer to be used (i.e., a test performed on a 2-inch thick drainage layer cannot be used to represent the maximum water retention value for a 4-inch thick drainage layer). In the absence of laboratory test results, the baseline default values must be used as provided in Equation 3.1 below, which shall be used to determine the storage volume retained by a green roof.

**Irrigation and Storage Volume.** Regularly irrigated green roofs receive 50% retention value for the amount of  $S_v$  provided by the practice. Only intensive systems may be irrigated.

### Equation 3.1 Storage Volume for Green Roofs

$$Sv = \frac{SA \times [(d \times MWR_1) + (DL \times MWR_2)]}{12} \times IF$$

where:

- $Sv$  = green roof storage volume (ft<sup>3</sup>)
- $SA$  = green roof area (ft<sup>2</sup>)
- $d$  = media depth (in.) (minimum 3 in.)
- $MWR_1$  = verified media maximum water retention (use 0.10 as a baseline default in the absence of verification data)
- $DL$  = drainage layer depth (in.) (if the drainage layer is combined with the media layer, then this value is 0)
- $MWR_2$  = verified drainage layer maximum water retention (use 0.0 as a baseline default in the absence of verification data)
- $IF$  = irrigation factor (0.5 for irrigated green roofs, 1.0 for unirrigated green roofs)

The appropriate  $Sv$  can then be compared to the required  $SWR_v$  for the entire rooftop area (including all conventional roof areas) to determine the portion of the design storm captured.

Green roofs can have dramatic rate attenuation effects on larger storm events and may be used, in part, to manage a portion of the 2-year and 15-year events. Designers can model various approaches by factoring in storage within the drainage layer. Routing calculations can also be used to provide a more accurate solution of the peak discharge and required storage volume.

#### 3.2.5 Green Roof Landscaping Criteria

Plant selection, landscaping, and maintenance are critical to the performance and function of green roofs. Therefore, a landscaping plan shall be provided for green roofs.

It is recommended that the planting plan for a green roof be prepared by a landscape architect, horticulturalist, or other professional experienced with green roofs. The planting plan must be submitted with the SWMP.

Plant selection for green roofs is an integral design consideration, which is governed by local climate and design objectives. The primary ground cover for most green roof installations is a hardy, low-growing succulent, such as *Sedum spp.*, *Delosperma spp.*, *Talinum spp.*, *Semperivum spp.*, or *Hieracium spp.* that is matched to the local climate conditions and can tolerate the difficult growing conditions found on building rooftops (Snodgrass and Snodgrass (see section 3.2.9, “References.”)).

A list of some common green roof plant species that work well in the Chesapeake Bay watershed can be found in Table 3-2 below.

**Table 3-2 Ground Covers Appropriate for Green Roofs in the District of Columbia**

Plant	Light	Moisture Requirement	Notes
<i>Delosperma cooperii</i>	Full Sun	Dry	Pink flowers; grows rapidly
<i>Delosperma 'Kelaidis'</i>	Full Sun	Dry	Salmon flowers; grows rapidly
<i>Delosperma nubigenum 'Basutoland'</i>	Full Sun	Moist-Dry	Yellow flowers; very hardy
<i>Sedum album</i>	Full Sun	Dry	White flowers; hardy
<i>Sedum lanceolatum</i>	Full Sun	Dry	Yellow flowers; native to U.S.
<i>Sedum oreganum</i>	Part Shade	Moist	Yellow flowers; native to U.S.
<i>Sedum stoloniferum</i>	Sun	Moist	Pink flowers; drought tolerant
<i>Sedum telephiodes</i>	Sun	Dry	Blue green foliage; native to region
<i>Sedum ternatum</i>	Part Shade	Dry-Moist	White flowers; grows in shade
<i>Talinum calycinum</i>	Sun	Dry	Pink flowers; self-sows

Note: Designers should choose species based on shade tolerance, ability to sow or not, foliage height, and spreading rate. See Snodgrass and Snodgrass (see section 3.2.9, “References.”) for a definitive list of green roof plants, including accent plants.

- Plant choices can be much more diverse for deeper intensive green roof systems. Herbs, forbs, grasses, shrubs, and even trees can be used, but designers should understand they may have higher watering, weeding, landscape maintenance, and soil volume requirements.
- The species and layout of the planting plan must reflect the location of the building, in terms of its height, exposure to wind, snow loading, heat stress, orientation to the sun, and impacts from surrounding buildings. Wind scour and solar burning have been observed on green roof installations that failed to adequately account for neighboring building heights and surrounding window reflectivity. In addition, plants must be selected that are fire resistant and able to withstand heat, cold, and high winds.
- Designers should also match species to the expected rooting depth of the growing media, which can also provide enough lateral growth to stabilize the growing media surface. The planting plan should usually include several accent plants to provide diversity and seasonal color. For a comprehensive resource on green roof plant selection, consult Snodgrass and Snodgrass (see section 3.2.9, “References.”).
- It is also important to note that most green roof plant species will not be native to the Chesapeake Bay watershed (which contrasts with native plant recommendations for other stormwater practices, such as bioretention and constructed wetlands).
- Given the limited number of green roof plant nurseries in the region, it may be necessary for designers to order plants 6 to 12 months prior to the expected planting date. It is also advisable to have plant materials contract grown.

- Plants can be established using cuttings, plugs, mats, and, more rarely, containers. Several vendors also sell mats, rolls, or proprietary green roof planting modules. For the pros and cons of each method, see Snodgrass and Snodgrass (see section 3.2.9, “References.”). To achieve 50% coverage after one (1) year and 80% coverage after two (2) years, the recommended minimum spacing for succulent plantings is 2 plugs per square foot and 3 pounds of cuttings per 100 square feet.
- When planting cuttings, plugs, and mats, the planting window extends from the spring to early fall; although, it is important to allow plants to root thoroughly before the first killing frost. Green roof manufacturers and plant suppliers may provide guidance on planting windows as well as winter care. Proper planting and care may also be required for plant warranty eligibility.
- When appropriate species are selected, most green roofs will not require supplemental irrigation, except for temporary irrigation during drought or initial establishment. The use of water-efficient designs and/or use of non-potable sources is strongly encouraged. Permanent irrigation of extensive roof designs is prohibited. For intensive roofs, permanent irrigation may be included. However, permanent irrigation can adversely impact the rainfall retention capacity of the green roof. For this reason, soil moisture monitors are a required part of the irrigation system for all irrigated green roofs, and the calculated retention value for green roofs with permanent irrigation must be reduced by 50%.
- The goal for green roof systems designed for stormwater management is to establish a full and vigorous cover of low-maintenance vegetation that is self-sustaining (not requiring fertilizer inputs) and requires minimal mowing, trimming, and weeding.

The green roof design should include non-vegetated walkways (e.g., paver blocks) to allow for easy access to the roof for weeding and making spot repairs (see Section 3.2.4, “Green Roof Design Criteria”).

### 3.2.6 Green Roof Construction Sequence

**Green Roof Installation.** Given the diversity of extensive vegetated roof designs, there is no typical step-by-step construction sequence for proper installation. The following general construction considerations are noted:

- Construct the roof deck with the appropriate slope and material.
- Install the waterproofing method, according to manufacturer’s specifications.
- Conduct leak detection to ensure the system is watertight. Where possible, electronic leak detection is strongly recommended over a flood test, but not all impermeable membranes and deck systems are compatible with this method. If electronic leak detection systems are not possible, a flood test should be performed instead. The flood test is done by placing at least two (2) inches of water over the membrane for at least 48 hours to confirm the integrity of the waterproofing system.
- Add additional system components (e.g., insulation, root barrier, drainage layer and interior drainage system, and filter fabric) per the manufacturer’s specifications, taking care not to damage the waterproofing. Any damage occurring must be reported immediately. Drain collars and protective flashing should be installed to ensure free flow of excess stormwater.

- The growing media should be mixed prior to delivery to the site. Media must be spread evenly over the filter fabric surface as required by the manufacturer. If a delay between the installation of the growing media and the plants is required, adequate efforts must be taken to secure the growing media from erosion and the seeding of weeds. The growing media must be covered and anchored in place until planting. Sheets of exterior grade plywood can also be laid over the growing media to accommodate foot or wheelbarrow traffic. Foot traffic and equipment traffic should be limited over the growing media to reduce compaction beyond manufacturer's recommendations.
- The growing media should be moistened prior to planting, and then planted with the ground cover and other plant materials, per the planting plan or in accordance with ASTM E2400 (2015). Plants should be watered immediately after installation and routinely during establishment.
- It generally takes 2 to 3 growing seasons to fully establish the vegetated roof. The growing medium should contain enough organic matter to support plants for the first growing season, so initial fertilization is not required. Extensive green roofs may require supplemental irrigation during the first few months of establishment. Hand weeding is also critical in the first 2 years (see Table 10.1 of Weiler and Scholz-Barth (2009) for a photo guide of common rooftop weeds).
- Most construction contracts should contain a care and replacement warranty that specifies at least 50% coverage after 1 year and 80% coverage after 2 years for plugs and cuttings, and 90% coverage after 1 year for *Sedum* carpet or tile.

**Construction Supervision.** Supervision during construction is recommended to ensure that the vegetated roof is built in accordance with these specifications. Inspection checklists should be used that include sign-offs by qualified individuals at critical stages of construction and confirm that the contractor's interpretation of the plan is consistent with the intent of the designer and/or manufacturer.

An experienced installer should be retained to construct the vegetated roof system. The vegetated roof should be constructed in sections for easier inspection and maintenance access to the membrane and roof drains. Careful construction supervision/inspection is needed throughout the installation of a vegetated roof, as follows:

- During placement of the waterproofing layer to ensure that it is properly installed and watertight.
- During placement of the drainage layer and drainage system.
- During placement of the growing media, to confirm that it meets the specifications and is applied to the correct depth (certification for vendor or source should be provided).
- Upon installation of plants, to ensure they conform to the planting plan (certification from vendor or source should be provided).
- Before issuing use and occupancy approvals.
- At the end of the first or second growing season to ensure that the desired surface cover specified in the Care and Replacement Warranty has been achieved.



DOEE's construction phase inspection checklist for green roof practices can be found in Appendix L - Construction Inspection Checklists.

### **3.2.7 Green Roof Maintenance Criteria**

**Maintenance Inspections.** A green roof should be inspected by a qualified professional twice a year during the growing season to assess vegetative cover and to look for leaks, drainage problems, and any rooftop structural concerns (see Table 3-3). In addition, the green roof should be hand weeded to remove invasive or volunteer plants, and plants and/or media should be added to repair bare areas (refer to ASTM E2400 (ASTM, 2015)).

If a roof leak is suspected, it is advisable to perform an electric leak survey if applicable, to pinpoint the exact location, make localized repairs, and then reestablish system components and ground cover.

The use of herbicides, insecticides, and fungicides should be avoided, since their presence could hasten degradation of some waterproofing membranes. Check with the membrane manufacturer for approval and warranty information. Also, power washing and other exterior maintenance operations should be avoided so that cleaning agents and other chemicals do not harm the green roof plant communities.

Fertilization is generally not recommended due to the potential for leaching of nutrients from the green roof. Supplemental fertilization may be required following the first growing season, but only if plants show signs of nutrient deficiencies and a media test indicates a specific deficiency. Addressing this issue with the holder of the vegetation warranty is recommended. If fertilizer is to be applied, it must be a slow-release type, rather than liquid or gaseous form.

DOEE's maintenance inspection checklist for green roofs and the Maintenance Service Completion Inspection form can be found in Appendix M - Maintenance Inspection Checklists.

**Table 3-3 Typical Maintenance Activities Associated with Green Roofs**

Schedule (following construction)	Activity
As needed or as required by manufacturer	<ul style="list-style-type: none"> <li>▪ Water to promote plant growth and survival.</li> <li>▪ Inspect the green roof and replace any dead or dying vegetation.</li> </ul>
Semi-annually	<ul style="list-style-type: none"> <li>▪ Inspect the waterproof membrane for leaks and cracks.</li> <li>▪ Weed to remove invasive plants and tree seedlings (do not dig or use pointed tools where there is potential to harm the root barrier or waterproof membrane).</li> <li>▪ Inspect roof drains, scuppers, and gutters to ensure they are not overgrown and have not accumulated organic matter deposits. Remove any accumulated organic matter or debris.</li> <li>▪ Inspect the green roof for dead, dying, or invasive vegetation. Plant replacement vegetation as needed.</li> <li>▪ For roofs with a rock or mineral wool drainage layer, inspect green roof areas for evidence of settlement or ponding in the vegetation layer (as they may compress over time). If settlement exceeds two inches in depth and covers 20% of the green roof surface area, replacement of the drainage layer is required.</li> </ul>

**Declaration of Covenants.** A declaration of covenants is required that includes all maintenance responsibilities to ensure the continued stormwater performance for the BMP. The declaration of covenants specifies the property owner’s primary maintenance responsibilities, and authorizes DOEE staff to access the property for inspection or corrective action in the event the proper maintenance is not performed. The declaration of covenants is recorded in the District of Columbia land records. A template form is provided at the end of Chapter 5, “Administration of Stormwater Management Rules” (see Figure 5.11), although variations will exist for situations in which stormwater crosses property lines. The covenant is between the property owner and the Government of the District of Columbia. It is submitted through the Office of the Attorney General. All SWMPs have a maintenance agreement stamp that must be signed for a building permit to be issued. A maintenance schedule must appear on the SWMP. Additionally, a maintenance schedule is required to be included as an exhibit to the declaration of covenants.

Covenants are not required on government properties, but maintenance responsibilities must be either signed by the Responsible Person for Maintenance on a partnership agreement or be identified in a memorandum of understanding that is incorporated into the plan submission.

**Waste Materials.** Waste material from the repair, maintenance, or removal of a BMP or land cover shall be removed and disposed of in compliance with applicable federal and District law.

### 3.2.8 Green Roof Stormwater Compliance Calculations

Green roofs receive 100% retention value for the amount of storage volume ( $S_v$ ) provided by the practice (see Table 3-4) and are considered an accepted total suspended solids (TSS) treatment practice.

**Table 3-4 Green Roof Design Performance**

Retention Value	= $S_v$
Accepted TSS Treatment Practice	Yes

The practice must be designed using the guidance in Section 3.2.4, “Green Roof Design Criteria.”

Green roofs also contribute to peak flow reduction. This contribution can be determined in several ways. One method is to subtract the storage volume ( $S_v$ ) from the total runoff volume for the 2-year, 15-year, and 100-year storms. The resulting reduced runoff volumes can then be used to calculate a reduced Natural Resource Conservation Service (NRCS) curve number (CN) for the site or SDA. The reduced NRCS CN can then be used to calculate peak flow rates for the various storm events. Other hydrologic modeling tools that employ different procedures may be used as well.

### 3.2.9 References

- ASTM D448-12 (2017), Standard Classification for Sizes of Aggregate for Road and Bridge Construction, ASTM International, West Conshohocken, PA, 2017, [www.astm.org](http://www.astm.org)
- ASTM E2396 / E2396M-15, Standard Test Method for Saturated Water Permeability of Granular Drainage Media [Falling-Head Method] for Vegetative (Green) Roof Systems, ASTM International, West Conshohocken, PA, 2015, [www.astm.org](http://www.astm.org)
- ASTM E2397 / E2397M-15, Standard Practice for Determination of Dead Loads and Live Loads Associated with Vegetative (Green) Roof Systems, ASTM International, West Conshohocken, PA, 2015, [www.astm.org](http://www.astm.org)
- ASTM E2398 / E2398M-15a, Standard Test Method for Water Capture and Media Retention of Geocomposite Drain Layers for Vegetative (Green) Roof Systems, ASTM International, West Conshohocken, PA, 2015, [www.astm.org](http://www.astm.org)
- ASTM E2399 / E2399M-15, Standard Test Method for Maximum Media Density for Dead Load Analysis of Vegetative (Green) Roof Systems, ASTM International, West Conshohocken, PA, 2015, [www.astm.org](http://www.astm.org)
- ASTM E2400 / E2400M-06(2015)e1, Standard Guide for Selection, Installation, and Maintenance of Plants for Green Roof Systems, ASTM International, West Conshohocken, PA, 2015, [www.astm.org](http://www.astm.org)
- ASTM D3776 / D3776M-09a (2017), Standard Test Methods for Mass Per Unit Area (Weight) of Fabric, ASTM International, West Conshohocken, PA, 2017, [www.astm.org](http://www.astm.org)

- ASTM D4751-16, Standard Test Methods for Determining Apparent Opening Size of a Geotextile, ASTM International, West Conshohocken, PA, 2016, [www.astm.org](http://www.astm.org)
- Clark, S., B. Long, C. Siu, J. Spicher and K. Steele. 2008. "Early-life runoff quality: green versus traditional roofs." *Low Impact Development 2008*. Seattle, WA. American Society of Civil Engineers.
- Dunnett, N. and N. Kingsbury. 2004. *Planting Green Roofs and Living Walls*. Timber Press. Portland, Oregon.
- Green Roof Infrastructure: Plants and Growing Medium 401. Participant Manual. <https://greenroofs.org/>
- Luckett, K. 2009. *Green Roof Construction and Maintenance*. McGraw-Hill Companies, Inc.
- Northern Virginia Regional Commission (NVRC). 2007. *Low Impact Development Manual*. "Vegetated Roofs." Fairfax, VA.
- Snodgrass, E. and L. Snodgrass. 2006. *Green Roof Plants: a resource and planting guide*. Timber Press. Portland, OR.
- Weiler, S. and K. Scholz-Barth. 2009. *Green Roof Systems: A Guide to the Planning, Design, and Construction of Landscapes over Structure*. Wiley Press. New York, NY.
- Virginia DCR Stormwater Design Specification No. 5: Vegetated Roof Version 2.2. 2010.

### 3.3 Rainwater Harvesting

**Definition.** Rainwater harvesting systems store rainfall and release it for future use. Rainwater that falls on a rooftop or other impervious surface is collected and conveyed into an above- or below-ground tank (also referred to as a cistern), where it is stored for non-potable uses or for on-site disposal or infiltration as stormwater. Cisterns can be sized for commercial as well as residential purposes. Residential cisterns are commonly called rain barrels. The design includes the following:

#### R-1 Rainwater harvesting for non-potable uses

Non-potable uses of harvested rainwater may include the following:

- Landscape irrigation,
- Exterior washing (e.g., car washes, building facades, sidewalks, street sweepers, and fire trucks),
- Flushing of toilets and urinals,
- Fire suppression (e.g., sprinkler systems),
- Supply for cooling towers, evaporative coolers, fluid coolers, and chillers,
- Supplemental water for closed loop systems and steam boilers,
- Replenishment of water features and water fountains,
- Distribution to a green wall or living wall system, and
- Laundry.

By providing a reliable and renewable source of water to end users, rainwater harvesting systems can also have environmental and economic benefits beyond stormwater management (e.g., increased water conservation, water supply during drought and mandatory municipal water supply restrictions, decreased demand on municipal water supply, decreased water costs for the end user, and potential for increased groundwater recharge).

The seven primary components of a rainwater harvesting system are discussed in detail in Section 3.3.4, “Rainwater Harvesting Design Criteria.” Some are depicted in Figure 3.4. The components include the following:

- CDA surface,
- Collection and conveyance system (e.g., gutter and downspouts) (number 1 in Figure 3.4)
- Pretreatment, including prescreening and first flush diverters (number 2 in Figure 3.4)
- Cistern (no number, but depicted in Figure 3.4)
- Water quality treatment (as required by Appendix N - Rainwater Harvesting Treatment and Management Requirements)
- Distribution system

- Overflow, filter path, or secondary stormwater retention practice (number 8 in Figure 3.4)

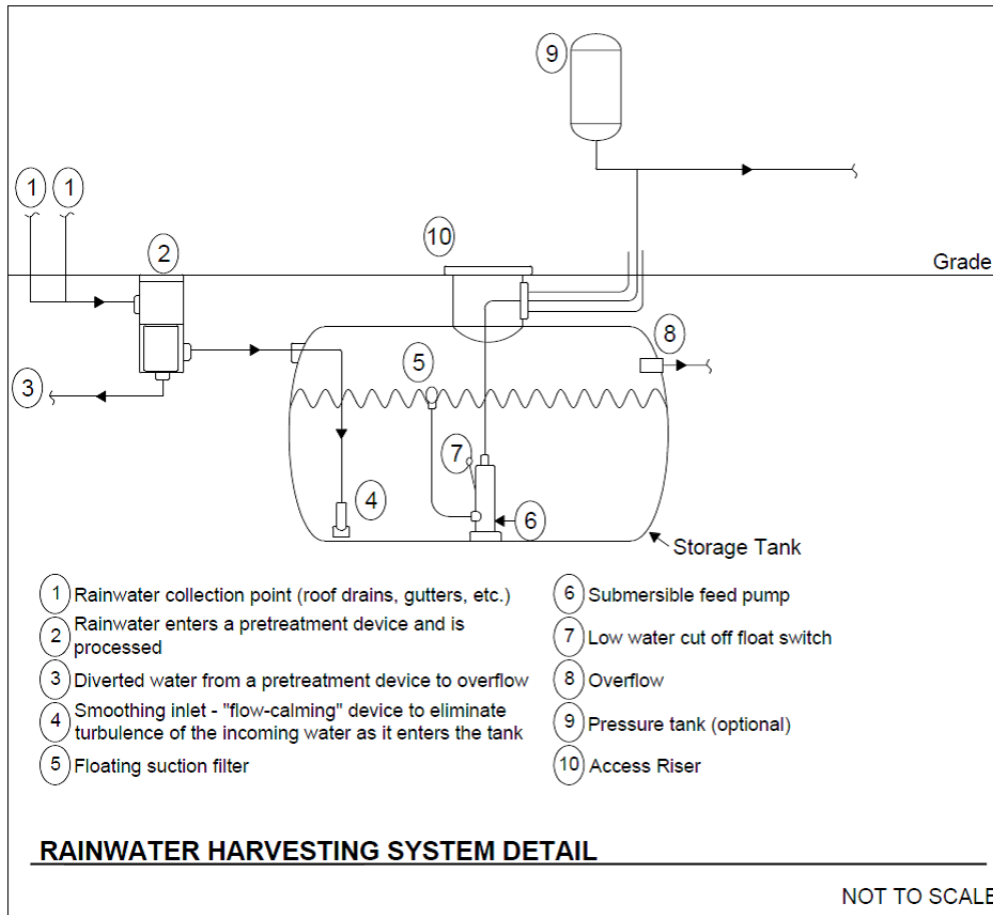


Figure 3.4 Example of a rainwater harvesting system detail.

### 3.3.1 Rainwater Harvesting Feasibility Criteria

A number of site-specific features influence how rainwater harvesting systems are designed and/or utilized. The following are key considerations for rainwater harvesting feasibility. They are not comprehensive or conclusive; rather, they are recommendations to consider during the planning process to incorporate rainwater harvesting systems into the site design.

**Plumbing Code.** Designers and plan reviewers should consult Appendix N - Rainwater Harvesting Treatment and Management Requirements and the District’s Construction Codes (Title 12 of the District of Columbia Municipal Regulations) to determine the allowable indoor uses and required treatment for harvested rainwater. In cases where a municipal backup supply is used, rainwater harvesting systems must have backflow preventers or air gaps to keep harvested water separate from the main water supply. Distribution and waste pipes, internal to the building, must be stamped non-potable and colored purple consistent with the District’s building codes. Pipes and spigots using rainwater must be clearly labeled as non-potable with an accompanying pictograph sign.

**Mechanical, Electrical, Plumbing.** For systems that call for indoor use of harvested rainwater, the seal of a mechanical, electrical, and plumbing engineer is required.

**Water Use.** When rainwater harvesting will be used, the requirements in Appendix N - Rainwater Harvesting Treatment and Management Requirements must be followed. This will outline the design assumptions and provide water quality end use standards.

**Available Space.** Adequate space is needed to house the cistern and any overflow. Space limitations are rarely a concern with rainwater harvesting systems if they are considered during the initial building design and site layout of a residential or commercial development. Cisterns can be placed underground, indoors, adjacent to buildings, and on rooftops that are structurally designed to support the added weight. Designers can work with architects and landscape architects to creatively site the cisterns. Underground utilities or other obstructions should always be identified prior to final determination of the cistern location.

**Site Topography.** Site topography and cistern location should be considered as they relate to all of the inlet and outlet invert elevations in the rainwater harvesting system.

The final invert of the cistern outlet pipe at the discharge point must match the invert of the receiving mechanism (e.g., natural channel, storm drain system) and be sufficiently sloped to adequately convey this overflow. The elevation drops associated with the various components of a rainwater harvesting system and the resulting invert elevations should be considered early in the design, in order to ensure that the rainwater harvesting system is feasible for the particular site.

Site topography and cistern location will also affect pumping requirements. Locating cisterns in low areas will make it easier to get water into the cisterns; however, it will increase the amount of pumping needed to distribute the harvested rainwater back into the building or to irrigated areas situated on higher ground. Conversely, placing cisterns at higher elevations may require larger diameter pipes with smaller slopes but will generally reduce the amount of pumping needed for distribution. It is often best to locate a cistern close to the building or SDA, to limit the amount of pipe needed.

**Available Hydraulic Head.** The required hydraulic head depends on the intended use of the water. For residential landscaping uses, the cistern may be sited up-gradient of the landscaping areas or on a raised stand. Pumps are commonly used to convey stored rainwater to the end use in order to provide the required head. When the water is being routed from the cistern to the inside of a building for non-potable use, often a pump is used to feed a much smaller pressure tank inside the building, which then serves the internal water demands. Cisterns can also use gravity to accomplish indoor residential uses (e.g., laundry) that do not require high water pressure.

**Water Table.** Underground storage tanks are most appropriate in areas where the tank can be buried above the water table. The tank should be located in a manner that does not subject it to flooding. In areas where the tank is to be buried partially below the water table, special design features must be employed, such as sufficiently securing the tank (to keep it from floating), and conducting buoyancy calculations when the tank is empty. The tank may need to be secured

appropriately with fasteners or weighted to avoid uplift buoyancy. The combined weight of the tank and hold-down ballast must meet or exceed the buoyancy force of the cistern. The cistern must also be installed according to the cistern manufacturer's specifications.

**Soils.** Cisterns should only be placed on native soils or on fill in accordance with the manufacturer's guidelines. The bearing capacity of the soil upon which the cistern will be placed must be considered, as full cisterns can be very heavy. This is particularly important for above-ground cisterns, as significant settling could cause the cistern to lean or in some cases to potentially topple. A sufficient aggregate, or concrete foundation, may be appropriate depending on the soils and cistern characteristics. Where the installation requires a foundation, the foundation must be designed to support the cistern's weight when the cistern is full, consistent with the bearing capacity of the soil and good engineering practice. The pH of the soil should also be considered in relation to its interaction with the cistern material.

**Proximity of Underground Utilities.** All underground utilities must be taken into consideration during the design of underground rainwater harvesting systems, treating all of the rainwater harvesting system components and storm drains as typical stormwater facilities and pipes. The underground utilities must be marked and avoided during the installation of underground cisterns and piping associated with the system.

**Contributing Drainage Area.** The CDA to the cistern is the area draining to the cistern. Rooftop surfaces are what typically make up the CDA, but paved areas can be used with appropriate treatment (oil/water separators and/or debris excluders).

**Contributing Drainage Area Material.** The quality of the harvested rainwater will vary according to the roof material or CDA over which it flows. Water harvested from certain types of rooftops and CDAs, such as asphalt sealcoats, tar and gravel, painted roofs, galvanized metal roofs, sheet metal, or any material that may contain asbestos may leach trace metals and other toxic compounds. In general, harvesting rainwater from such surfaces should be avoided. If harvesting from a sealed or painted roof surface is desired, it is recommended that the sealant or paint be certified for such purposes to NSF Protocol P151 (see Section 3.3.9, "References").

**Water Quality of Rainwater.** Designers should also note that the pH of rainfall in the District tends to be acidic (ranging from 4.5 to 5.0), which may result in leaching of metals from roof surfaces, cistern lining, or water laterals, to interior connections. Once rainfall leaves rooftop surfaces, pH levels tend to be slightly higher, ranging from 5.5 to 6.0. Limestone or other materials may be added in the cistern to buffer acidity, if desired.

**Hotspot Land Uses.** Harvesting rainwater can be an effective method to prevent contamination of rooftop runoff that would result from mixing it with ground-level runoff from a stormwater hotspot operation.

**Setbacks from Buildings.** Cistern overflow devices must be designed to avoid causing ponding or soil saturation within 10 feet of building foundations. While most systems are generally sited underground and more than 10 feet laterally from the building foundation wall, some cisterns are incorporated into the basement of a building or underground parking areas. In any case, cisterns



must be designed to be watertight to prevent water damage when placed near building foundations.

**Vehicle Loading.** Whenever possible, underground rainwater harvesting systems should be placed in areas without vehicle traffic or other heavy loading, such as deep earth fill. If site constraints dictate otherwise, systems must be designed to support the loads to which they will be subjected.

### 3.3.2 Rainwater Harvesting Conveyance Criteria

**Collection and Conveyance.** The collection and conveyance system consists of the gutters, downspouts, and pipes that channel rainfall into cisterns. Gutters and downspouts should be designed as they would for a building without a rainwater harvesting system. If the system will be used for management of the 2-year and 15-year storms, the gutters must be designed to convey the appropriate 2-year and 15-year storm intensities.

Pipes, which connect downspouts to the cistern, should be at a minimum slope of 1.5% and sized/designed to convey the intended design storm, as specified above. In some cases, a steeper slope and larger sizes may be recommended and/or necessary to convey the required runoff, depending on the design objective and design storm intensity. Gutters and downspouts should be kept clean and free of debris and rust.

**Overflow.** An overflow mechanism must be included in the rainwater harvesting system design in order to handle an individual storm event or multiple storms in succession that exceed the capacity of the cistern. The overflow pipe(s) must have a capacity greater than or equal to the inflow pipe(s) and have a diameter and slope sufficient to drain the cistern while maintaining an adequate freeboard height. The overflow pipe(s) must be screened to prevent access to the cistern by small mammals and birds and must include a backflow preventer if it connects directly to the combined sewer or storm sewer. All overflow from the system must be directed to an acceptable flow path that will not cause erosion during a 2-year storm event.

### 3.3.3 Rainwater Harvesting Pretreatment Criteria

Prefiltration is required to keep sediment, leaves, contaminants, and other debris from the system. Leaf screens and gutter guards meet the minimal requirement for prefiltration of small systems, although direct water filtration is preferred. The purpose of prefiltration is to significantly cut down on maintenance by preventing organic buildup in the cistern, thereby decreasing microbial food sources.

Various pretreatment devices are described below. In addition to the initial first flush diversion, filters have an associated efficiency curve that estimates the percentage of rooftop runoff that will be conveyed through the filter to the cistern. If filters are not sized properly, a large portion of the rooftop runoff may be diverted and not conveyed to the cistern at all. A design intensity of 1 inch per hour (for design storm = SWR<sub>v</sub>) must be used for the purposes of sizing pre-cistern conveyance and filter components. This design intensity captures a significant portion of the total rainfall during a large majority of rainfall events (NOAA, 2004). If the system will be used for channel and flood protection, the 2-year and 15-year storm intensities must be used for the design of the conveyance and pretreatment portion of the system. The Rainwater Harvesting

Storage Volume Calculator, discussed more in Section 3.3.4, “Rainwater Harvesting Design Criteria,” allows for input of variable filter efficiency rates for the design storm. To meet the requirements to manage the 2-year and 15-year storms, a minimum filter efficiency of 90% must be met.

- **First Flush Diverters.** First flush diverters (see Figure 3.5) direct the initial pulse of rainfall away from the cistern. While leaf screens effectively remove larger debris such as leaves, twigs, and blooms from harvested rainwater, first flush diverters can be used to remove smaller contaminants such as dust, pollen, and bird and rodent feces.
- **Leaf Screens.** Leaf screens are mesh screens installed over either the gutter or downspout to separate leaves and other large debris from rooftop runoff. Leaf screens must be regularly cleaned to be effective; if not maintained, they can become clogged and prevent rainwater from flowing into the cisterns. Built-up debris can also harbor bacterial growth within gutters or downspouts (Texas Water Development Board, 2005).
- **Roof Washers.** Roof washers are placed just ahead of cisterns and are used to filter small debris from harvested rainwater (see Figure 3.6). Roof washers consist of a cistern, usually between 25 and 50 gallons in size, with leaf strainers and a filter with openings as small as 30 microns. The filter functions to remove very small particulate matter from harvested rainwater. All roof washers must be cleaned on a regular basis.
- **Hydrodynamic Separator.** For large-scale applications, hydrodynamic separators and other devices can be used to filter rainwater from larger CDAs.

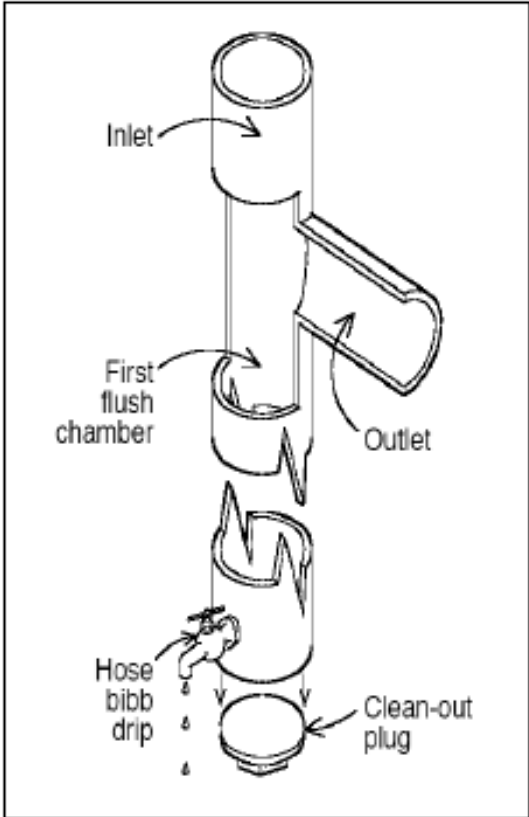


Figure 3.5 Diagram of a first flush diverter. (Texas Water Development Board, 2005)

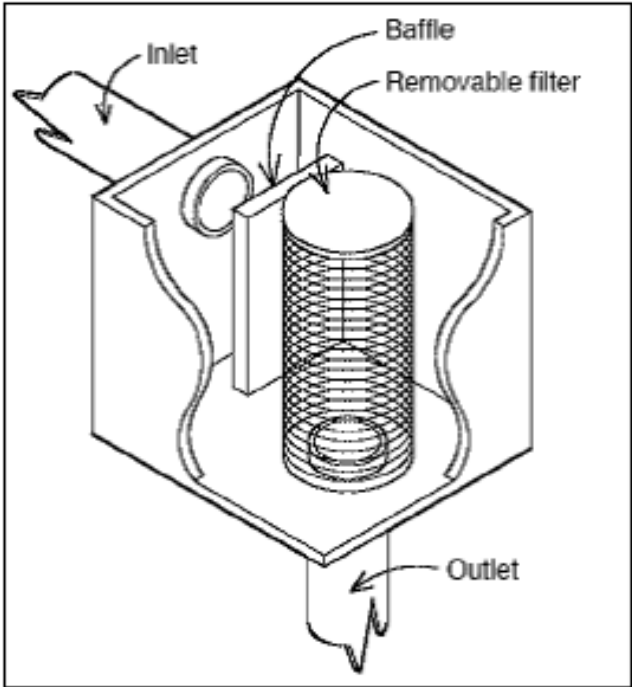


Figure 3.6 Diagram of a roof washer. (Texas Water Development Board, 2005)

### 3.3.4 Rainwater Harvesting Design Criteria

System Components: Seven primary components of a rainwater harvesting system require special considerations (some of these are depicted in Figure 3.3):

- CDA or CDA surface
- Collection and conveyance system (i.e., gutter and downspouts)
- Cisterns
- Pretreatment, including prescreening and first flush diverters
- Water quality treatment (as described in Appendix N - Rainwater Harvesting Treatment and Management Requirements)
- Distribution systems
- Overflow, filter path, or secondary stormwater retention practice

The system components are discussed below:

- **CDA Surface.** When considering CDA surfaces, smooth, non-porous materials will drain more efficiently. Slow drainage of the CDA leads to poor rinsing and a prolonged first flush, which can decrease water quality.

Rainwater can also be harvested from other impervious surfaces, such as parking lots and driveways; however, this practice requires more extensive pretreatment and treatment prior to use.

- **Collection and Conveyance System.** See Section 3.3.2, “Rainwater Harvesting Conveyance Criteria.”
- **Pretreatment.** See Section 3.3.3, “Rainwater Harvesting Pretreatment Criteria.”
- **Cisterns.** The cistern is the most important and typically the most expensive component of a rainwater harvesting system. Cistern capacities generally range from 250 to 30,000 gallons, but they can be as large as 100,000 gallons or more for larger projects. Multiple cisterns can be placed adjacent to each other and connected with pipes to balance water levels and to tailor the storage volume needed. Typical rainwater harvesting system capacities for residential use range from 1,500 to 5,000 gallons. Cistern volumes are calculated to meet the water demand and stormwater storage volume retention objectives, as described further below in this specification.

While many of the graphics and photos in this specification depict cisterns with a cylindrical shape, the cisterns can be made of many materials and configured in various shapes, depending on the type used and the site conditions where the cisterns will be installed. For example, configurations can be rectangular, L-shaped, or step vertically to match the topography of a site. The following factors should be considered when designing a rainwater harvesting system and selecting a cistern:

- ◆ Aboveground cisterns should be ultraviolet and impact resistant.

- ◆ Underground cisterns must be designed to support the overlying sediment and any other anticipated loads (e.g., vehicles, pedestrian traffic).
- ◆ Underground rainwater harvesting systems must have a standard size manhole or equivalent opening to allow access for cleaning, inspection, and maintenance purposes. The access opening must be installed in such a way as to prevent surface- or groundwater from entering through the top of any fittings, and it must be secured/locked to prevent unwanted entry. Confined space safety precautions/requirements should be observed during cleaning, inspection, and maintenance.
- ◆ All rainwater harvesting systems must be sealed using a water-safe, non-toxic substance.
- ◆ Rainwater harvesting systems may be ordered from a manufacturer or can be constructed on-site from a variety of materials. Table 3-5 below compares the advantages and disadvantages of different cistern materials.
- ◆ Cisterns must be opaque or otherwise protected from direct sunlight to inhibit growth of algae, and they must be screened to discourage mosquito breeding.
- ◆ Dead storage below the outlet to the distribution system and an air gap at the top of the cistern must be included in the total cistern volume. For gravity-fed systems, a minimum of 6 inches of dead storage must be provided. For systems using a pump, the dead storage depth will be based on the pump specifications.
- ◆ Any hookup to a municipal backup water supply must have a backflow prevention device to keep municipal water separate from stored rainwater; this may include incorporating an air gap to separate the two supplies.

**Table 3-5 Advantages and Disadvantages of Typical Cistern Materials (Source: Cabell Brand Center, 2007; Cabell Brand Center, 2009)**

Cistern Material	Advantages	Disadvantages
Fiberglass	Commercially available, alterable and moveable; durable with little maintenance; light weight; integral fittings (no leaks); broad application	Must be installed on smooth, solid, level footing; pressure proof for below-ground installation; expensive in smaller sizes
Polyethylene	Commercially available, alterable, moveable, affordable; available in wide range of sizes; can install above or below ground; little maintenance; broad application	Can be UV-degradable; must be painted or tinted for above-ground installations; pressure-proof for below-ground installation
Modular Storage	Can modify to topography; can alter footprint and create various shapes to fit site; relatively inexpensive	Longevity may be less than other materials; higher risk of puncturing of watertight membrane during construction
Plastic Barrels	Commercially available; inexpensive	Low storage capacity (20–50 gallons); limited application
Galvanized Steel	Commercially available, alterable, and moveable; available in a range of sizes; film develops inside to prevent corrosion	Possible external corrosion and rust; must be lined for potable use; can only install above ground; soil pH may limit underground applications
Steel Drums	Commercially available, alterable, and moveable	Small storage capacity; prone to corrosion, and rust can lead to leaching of metals; verify prior to reuse for toxics; water pH and soil pH may also limit applications
Ferroconcrete	Durable and immovable; suitable for above or below ground installations; neutralizes acid rain	Potential to crack and leak; expensive
Cast-in-Place Concrete	Durable, immovable, and versatile; suitable for above or below ground installations; neutralizes acid rain	Potential to crack and leak; permanent; will need to provide adequate platform and design for placement in clay soils
Stone or Concrete Block	Durable and immovable; keeps water cool in summer months	Difficult to maintain; expensive to build

- **Water Quality Treatment.** Depending upon the collection surface, method of dispersal, and proposed use for the harvested rainwater, a water quality treatment device may be required. Treatment requirements are described in Appendix N - Rainwater Harvesting Treatment and Management Requirements.
- **Distribution Systems.** Most distribution systems require a pump to convey harvested rainwater from the cistern to its final destination, whether inside the building, an automated irrigation system, or gradually discharged to a secondary stormwater treatment practice. The rainwater harvesting system should be equipped with an appropriately sized pump that produces sufficient pressure for all end-uses.

The typical pump and pressure tank arrangement consists of a multi-stage, centrifugal pump, which draws water out of the cistern and sends it into the pressure tank, where it is stored for distribution. Some systems will not require this two-tank arrangement (e.g., low-pressure and gravel systems). When water is drawn out of the pressure tank, the pump activates to supply

additional water to the distribution system. The backflow preventer is required to separate harvested rainwater from the main potable water distribution lines.

Distribution lines from the rainwater harvesting system should be buried beneath the frost line. Lines from the rainwater harvesting system to the building should have shut-off valves that are accessible when snow cover is present. A drain plug or cleanout sump must be installed to allow the system to be completely emptied, if needed. Above-ground outdoor pipes must be insulated or heat-wrapped to prevent freezing and ensure uninterrupted operation during winter if winter use is planned.

- **Overflow.** See Section 3.3.2, “Rainwater Harvesting Conveyance Criteria.”.

**Rainwater Harvesting Material Specifications.** The basic material specifications for rainwater harvesting systems are presented in Table 3-6. Designers should consult with experienced rainwater harvesting system and irrigation installers on the choice of recommended manufacturers of prefabricated cisterns and other system components.

**Table 3-6 Design Specifications for Rainwater Harvesting Systems**

Item	Specification
Gutters and Downspouts	<p>Materials commonly used for gutters and downspouts include polyvinylchloride (PVC) pipe, vinyl, aluminum, and galvanized steel. Lead must not be used as gutter and downspout solder, since rainwater can dissolve the lead and contaminate the water supply.</p> <ul style="list-style-type: none"> <li>▪ The length of gutters and downspouts is determined by the size and layout of the catchment and the location of the cisterns.</li> <li>▪ Include needed bends and tees.</li> </ul>
Pretreatment	<p>At least one of the following (all rainwater to pass through pretreatment):</p> <ul style="list-style-type: none"> <li>▪ First flush diverter</li> <li>▪ Hydrodynamic separator</li> <li>▪ Roof washer</li> <li>▪ Leaf screen</li> </ul>
Cisterns	<ul style="list-style-type: none"> <li>▪ Materials used to construct cisterns must be structurally sound.</li> <li>▪ Cisterns should be constructed in areas of the site where soils can support the load associated with stored water.</li> <li>▪ Cisterns must be watertight and sealed using a water-safe, non-toxic substance.</li> <li>▪ Cisterns must be opaque or otherwise shielded to prevent the growth of algae.</li> <li>▪ The size of the rainwater harvesting system(s) is determined through design calculations.</li> </ul>

Note: This table does not address indoor systems or pumps.

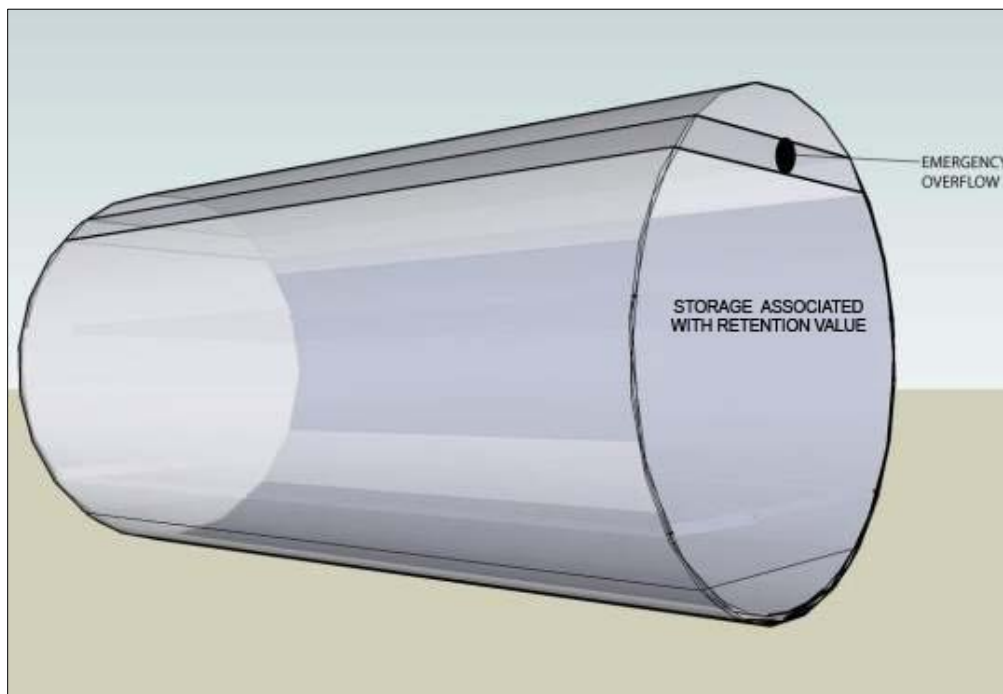
**Design Objectives and System Configuration.** Rainwater harvesting systems can have many design variations that meet user demand and stormwater objectives. This specification provides a design framework to achieve the SWRV objectives that are required to comply with the regulations, and it adheres to the following concepts:

- Give preference to use of rainwater as a resource to meet on-site demand or in conjunction with other stormwater retention practices.
- Reduce peak flow by achieving volume reduction and temporary storage of runoff.

Based on these concepts, this specification focuses on system design configurations that harvest rainwater for internal building uses, seasonal irrigation, and other activities, such as cooling tower use and vehicle washing. While harvested rainwater will be in year-round demand for many internal building uses, some other uses will have varied demand depending on the time of year (e.g., cooling towers and seasonal irrigation). Thus, a lower retention value is assigned to a type of use that has reduced demand.

**Design Objectives and Cistern Design Set-Ups.** Prefabricated rainwater harvesting cisterns typically range in size from 250 to over 30,000 gallons. Three basic cistern designs meet the various rainwater harvesting system configurations in this section.

- **Cistern Design 1.** The first cistern set-up (Figure 3.7) maximizes the available storage volume to meet the desired level of stormwater retention. This layout also maximizes the storage that can be used to meet a demand. An emergency overflow exists near the top of the cistern as the only gravity release outlet device (not including the pump, manway, or inlets). It should be noted that it is possible to address 2-year and 15-year storm volumes with this cistern configuration, but the primary purpose is to address the smaller SWR<sub>v</sub> design storm.

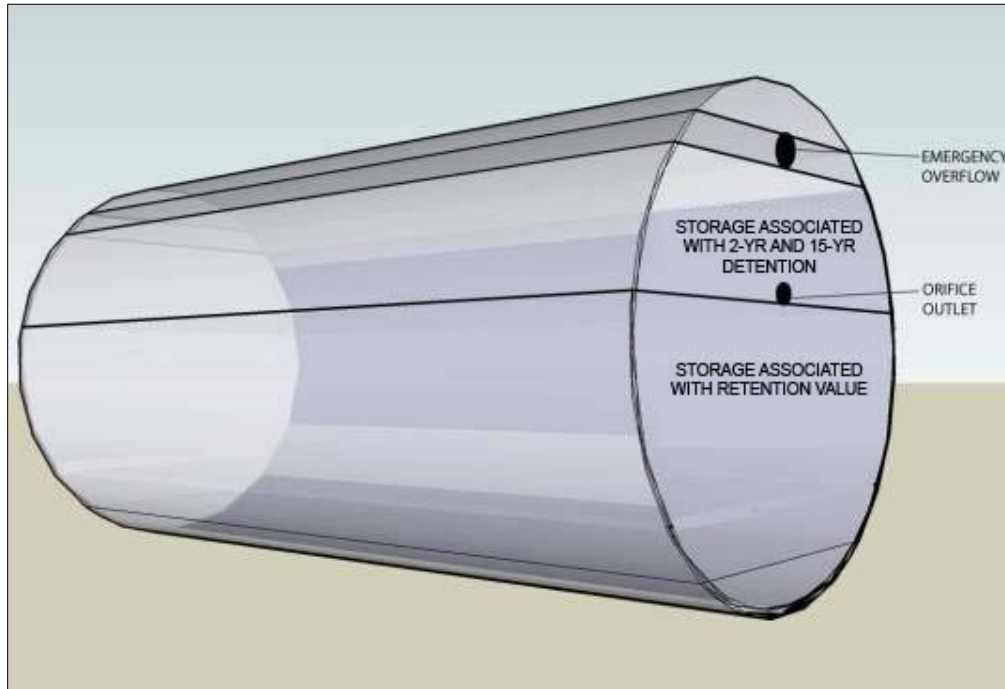


**Figure 3.7 Cistern Design 1: Storage associated with the design storm volume only.**

- **Cistern Design 2.** The second cistern set-up (Figure 3.8) uses cistern storage to meet the SWR<sub>v</sub> retention objectives and also uses additional detention volume to meet some or all of the 2-year and 15-year storm volume requirements. An orifice outlet is provided at the top of



the design storage for the SWR<sub>v</sub> level, and an emergency overflow is located at the top of the detention volume level.

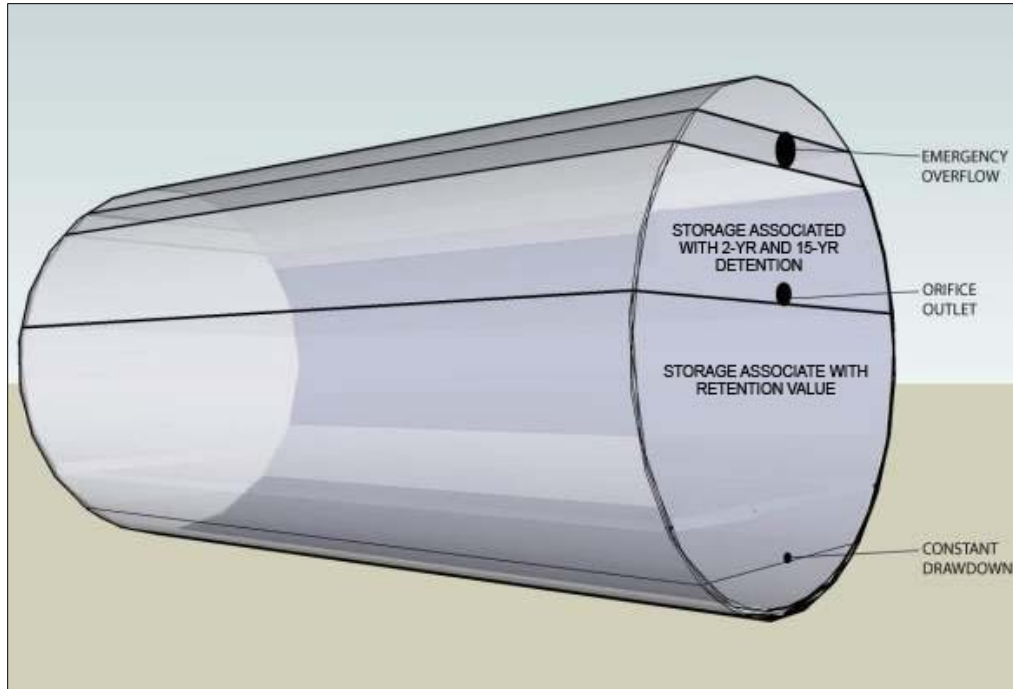


**Figure 3.8 Cistern Design 2: Storage associated with design storm, channel protection, and flood volume.**

- Cistern Design 3.** The third cistern set-up (Figure 3.8) creates a constant drawdown within the system. The small orifice at the bottom of the cistern needs to be routed to an appropriately designed secondary practice (i.e., bioretention, stormwater infiltration) that will allow the rainwater to be treated and allow for groundwater recharge over time. The release must not be discharged to a receiving channel or storm drain without treatment, and maximum specified drawdown rates from this constant drawdown should be adhered to, since the primary function of the system is not intended to be detention.

While a small orifice is shown at the bottom of the cistern in Figure 3.9, the orifice could be replaced with a pump that would serve the same purpose by conveying a limited amount of water to a secondary practice on a routine basis.

For this design, the secondary practice is considered a component of the rainwater harvesting system with regard to the storage volume calculated in the General Retention Compliance Calculator or Stormwater Database (discussed in Chapter 5, “Administration of Stormwater Management Rules,” and Appendix A - Compliance Calculations and Design Examples). In other words, the storage volume associated with the secondary practice must not be included as a separate BMP because the secondary practice is an integral part of a rainwater harvesting system with a constant drawdown.



**Figure 3.9 Cistern Design 3: Constant drawdown version where storage is associated with design storm, channel protection, and flood volume.**

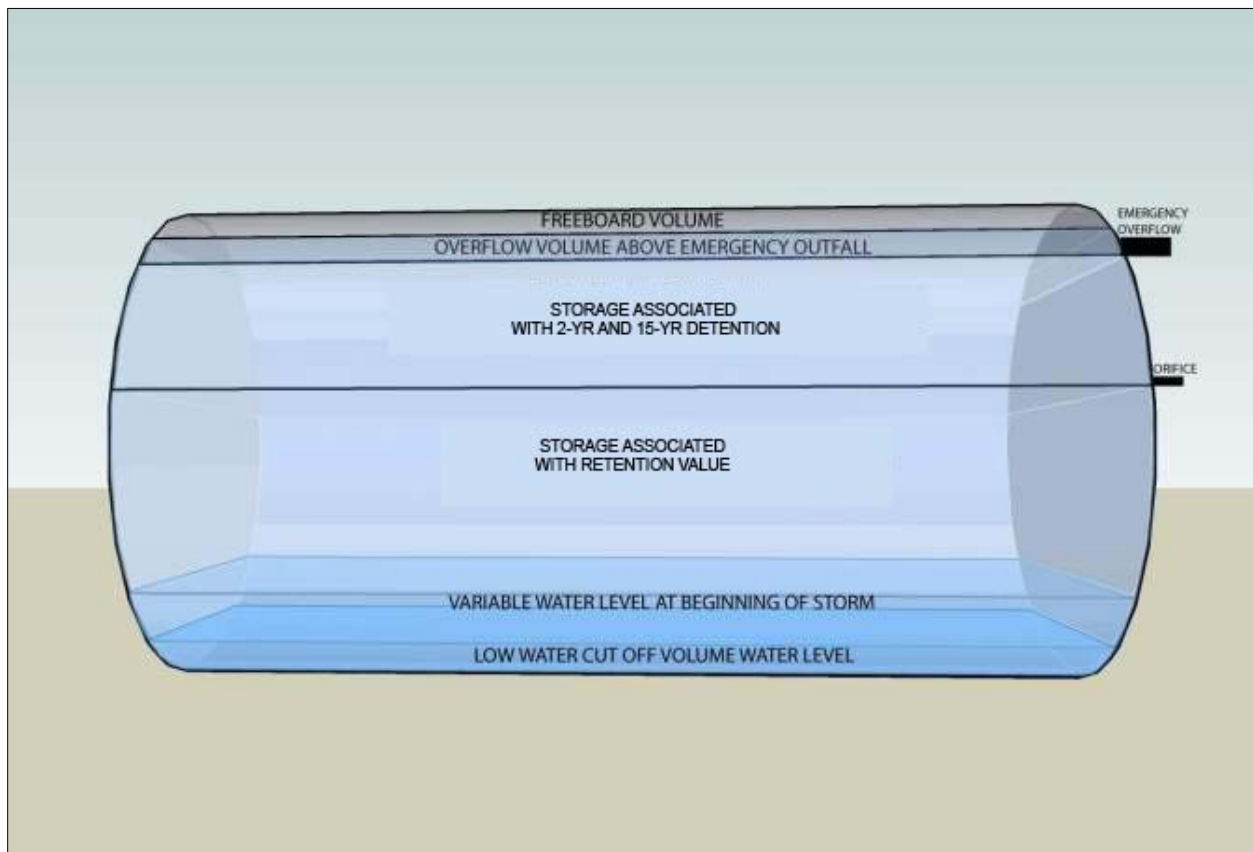
**Sizing of Rainwater Harvesting Systems.** The rainwater harvesting cistern sizing criteria presented in this section were developed using a spreadsheet model that used best estimates of indoor and outdoor water demand, long-term rainfall data, and CDA capture area data. The Rainwater Harvesting Storage Volume Calculator is for cistern sizing guidance and to quantify the retention value for storage volume achieved. This storage volume value is required for input into the General Retention Compliance Calculator or Stormwater Database and is part of the submission of a SWMP using rainwater harvesting systems for compliance. A secondary objective of the spreadsheet is to increase the beneficial uses of the stored stormwater, treating it as a valuable natural resource. More information on the Rainwater Harvesting Storage Volume Calculator follows. The spreadsheet can be found on DOEE’s website at <https://doee.dc.gov/swguidebook>.

**Rainwater Harvesting Storage Volume Calculator.** The design specification provided in this section is linked with the Rainwater Harvesting Storage Volume Calculator. The spreadsheet uses daily rainfall data from January 1, 1999, to March 10, 2019, to model performance parameters of the cistern under varying CDAs, demands on the system, and cistern size.

The runoff that reaches the cistern each day is added to the water level that existed in the cistern the previous day, with all of the total demands subtracted on a daily basis. If any overflow is realized, the volume is quantified and recorded. If the cistern runs dry (reaches the cut-off volume level), then the volume in the cistern is fixed at the low level. A summary of the water balance for the system is provided below.

**Incremental Design Volumes within Cistern.** Rainwater cistern sizing is determined by accounting for varying precipitation levels, captured CDA runoff, first flush diversion (through filters) and filter efficiency, low water cut-off volume, dynamic water levels at the beginning of various storms, storage needed for the design storm (permanent storage), storage needed for 2-year or 15-year volume (temporary detention storage), seasonal and year-round demand use and objectives, overflow volume, and freeboard volumes above high water levels during very large storms. See Figure 3.10 for a graphical representation of these various incremental design volumes.

The design specification described in this section does not provide guidance for sizing larger storms (e.g.,  $Q_{p2}$ ,  $Q_{p15}$ , and  $Q_f$ ), but rather provides guidance on sizing for the 1.7-inch design storm.



**Figure 3.10 Incremental design volumes associated with cistern sizing.**

The “Storage Associated with the Retention Value” is the average storage within the cistern that is modeled and available to retain rainfall. While the SWR<sub>v</sub> will remain the same for a specific CDA, the “Storage Associated with the Retention Value” is dependent on demand and storage volume retention objectives. It is the available space in the cistern between the average level at the beginning of a storm and the orifice outflow.

### Water Contribution

- **Precipitation.** The volume of water contributing to the rainwater harvesting system is a function of the rainfall and CDA, as defined by the designer.
- **Municipal Backup (optional).** In some cases, the designer may choose to install a municipal backup water supply to supplement cistern levels. Note that municipal backups may also be connected post-cistern (i.e., a connection is made to the non-potable water line that is used for pumping water from the cistern for reuse), thereby not contributing any additional volume to the cistern. Municipal backup designs that supply water directly to the cistern are not accounted for in the Rainwater Harvesting Storage Volume Calculator.

### Water Losses

- **Contributing Drainage Area Runoff Coefficient.** The CDA may include impervious cover with an  $R_v$  of 0.95, or compacted cover with an  $R_v$  of 0.25.
- **First Flush Diversion.** The first 0.02 to 0.06 inch of rainfall that is directed to filters is diverted from the system in order to prevent clogging it with debris. This value is assumed to be contained within the filter efficiency rate.
- **Filter Efficiency.** It is assumed that, after the first flush diversion and loss of water due to filter inefficiencies, the remainder of the design storm will be captured successfully. For the 1.2-inch storm, a minimum of 95% of the runoff should be conveyed into the cistern. For the 3.2-inch storm, a minimum of 90% of the runoff should be conveyed. These minimum values are included as the filter efficiencies in the Rainwater Harvesting Storage Volume Calculator, although they can be altered (increased) if appropriate. The Rainwater Harvesting Storage Volume Calculator applies these filter efficiencies, or interpolated values, to the daily rainfall record to determine the volume of runoff that reaches the cistern. For the purposes of selecting an appropriately sized filter, a rainfall intensity of 1 inch per hour shall be used when the design storm is the  $SWR_v$ . The appropriate rainfall intensity values for the 2-year (3.14-inch) and 15-year (5.23-inch) storms shall be used when designing for larger storm events.
- **Drawdown (Storage Volume).** This is the stored water within the cistern that is reused or directed to a secondary stormwater practice. It is the volume of runoff that is reduced from the CDA. This is the water loss that translates into the achievable storage volume retention.

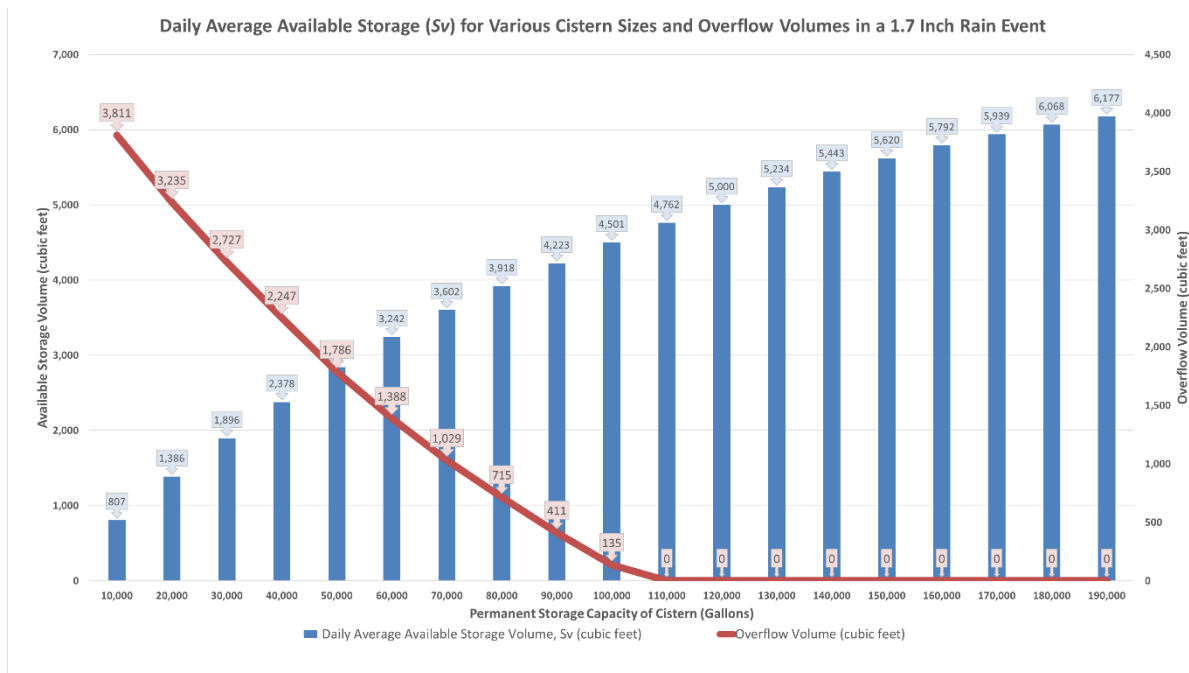
**Overflow.** For the purposes of addressing the  $SWR_v$  (not for addressing larger storm volumes), orifice outlets for both detention and emergency overflows are treated the same. This is the volume of water that may be lost during large storm events or successive precipitation events.

**Storage Volume Results.** The Rainwater Harvesting Storage Volume Calculator determines the average daily volume of water in the cistern for a range of cistern sizes. From this value, the available storage volume for the 1.7-inch storm can be calculated; it is simply the difference between the cistern size and the average daily volume. The available storage volume for the selected cistern size should be used as an input to the General Retention Compliance Calculator or Stormwater Database.

- **Available Storage Volume ( $S_v$ ).** The volume available for storage of the 1.7-inch storm is calculated for multiple sizes of cisterns. A trade-off graph plots these results, which allows

for a comparison of the retention achieved versus cistern size. While larger cisterns yield more retention, they are more costly. The graph helps the user to choose the appropriate cistern size, based on the design objectives and site needs.

- Overflow Volume.** The volume of the overflows resulting from a 1.7-inch precipitation event is also reported in this sheet. The overflow volume is also plotted to illustrate the effects of cistern size on overflow volume. An example chart is shown in Figure 3.11. The effect of diminishing returns is clear. Beyond a cistern size of 10,000 gallons, the overflow volume drops to zero. So, while the available storage continues to increase, the 1.7-inch storm is entirely retained, and no additional retention value will be possible.



**Figure 3.11 Example of available storage volume and overflow volume for various cistern sizes in a hypothetical example.**

**Results from the Rainwater Harvesting Storage Volume Calculator to be Transferred to the General Retention Compliance Calculator or Stormwater Database.** There are two results from the Rainwater Harvesting Storage Volume Calculator that are to be transferred to the General Retention Compliance Calculator or Stormwater Database, as follows:

- Contributing Drainage Area.** Enter the compacted cover and impervious cover CDAs that were used in the Rainwater Harvesting Storage Volume Calculator into the General Retention Compliance Calculator BMP Data sheet (column J and K).
- Available Storage Volume.** Once a cistern size has been selected, enter the Available Storage Volume (ft<sup>3</sup>) associated with that cistern into the General Retention Compliance

Calculator BMP Data Sheet column called “Storage Volume Provided by BMP” (column X). The storage volume is also needed for the Stormwater Database.

**Completing the Sizing Design of the Cistern.** The total size of the cistern is the sum of the following four volume components:

- **Low Water Cutoff Volume (Included).** A dead storage area must be included so the pump will not run the cistern dry. This volume is included in the Rainwater Harvesting Storage Volume Calculator’s modeled volume.
- **Cistern Storage Associated with Design Volume (Included).** This is the cistern design volume from the Rainwater Harvesting Storage Volume Calculator.
- **Adding Channel Protection and Flood Volumes (Optional).** Additional detention volume may be added above and beyond the cistern storage associated with the design storm volumes for the 2-year or 15-year events. Typical routing software programs may be used to design for this additional volume.
- **Adding Overflow and Freeboard Volumes (Required).** An additional volume above the emergency overflow must be provided in order for the cistern to allow very large storms to pass. Above this overflow water level, there will be an associated freeboard volume that should account for at least 5% of the overall cistern size. Sufficient freeboard must be verified for large storms, and these volumes must be included in the overall size of the cistern.

### 3.3.5 Rainwater Harvesting Landscaping Criteria

If the harvested water is to be used for irrigation, the design plan elements must include the proposed delineation of planting areas to be irrigated, the planting plan, and quantification of the expected water demand. The default water demand for irrigation is 1.0 inch per week over the area to be irrigated during the months of May through October only. Justification must be provided if larger volumes are to be used.

Note: If the irrigated area is a green roof, the green roof must be considered as compacted cover and not a stormwater BMP. Otherwise, rainwater harvesting cannot be considered a BMP and used to meet the SWRV, in which case the irrigation rules for green roofs, as described in Section 3.2.5, apply.

### 3.3.6 Rainwater Harvesting Construction Sequence

**Installation.** It is advisable to have a single contractor to install the rainwater harvesting system, outdoor irrigation system, and secondary retention practices. The contractor should be familiar with rainwater harvesting system sizing, installation, and placement. A licensed plumber is required to install the rainwater harvesting system components to the plumbing system.

A standard construction sequence for proper rainwater harvesting system installation is provided below. This can be modified to reflect different rainwater harvesting system applications or expected site conditions.

1. Choose the cistern location on the site.
2. Route all downspouts or pipes to prescreening devices and first flush diverters.
3. Properly install the cistern.
4. Install the pump (if needed) and piping to end uses (indoor, outdoor irrigation, or cistern dewatering release).
5. Route all pipes to the cistern.
6. Stormwater must not be diverted to the rainwater harvesting system until the overflow filter path has been stabilized with vegetation.

**Construction Supervision.** The following items should be inspected by a qualified professional in the mechanical, electrical, or plumbing fields prior to final sign-off and acceptance of a rainwater harvesting system:

- Rooftop area matches plans
- Diversion system is properly sized and installed
- Pretreatment system is installed
- Mosquito screens are installed on all openings (if applicable)
- Overflow device is directed as shown on plans
- Rainwater harvesting system foundation is constructed as shown on plans
- Catchment area and overflow area are stabilized
- Secondary stormwater treatment practice(s) is installed as shown on plans
- System commissioning

DOEE's construction phase inspection checklist for rainwater harvesting practices and the Stormwater Management Standard Testing Record form can be found in Appendix L - Construction Inspection Checklists.

### **3.3.7 Rainwater Harvesting Maintenance Criteria**

**Maintenance Inspections.** Periodic inspections and maintenance shall be conducted for each system by a qualified professional.

DOEE's maintenance inspection checklists for rainwater harvesting systems and the Maintenance Service Completion Inspection form can be found in Appendix M - Maintenance Inspection Checklists.

**Maintenance Schedule.** Maintenance requirements for rainwater harvesting systems vary according to use. Systems that are used to provide supplemental irrigation water have relatively low maintenance requirements, while systems designed for indoor uses have much higher maintenance requirements. Table 3-7 describes routine maintenance tasks necessary to keep rainwater harvesting systems in working condition. It is recommended that maintenance tasks be performed by an Inspector Specialist who is certified by the American Rainwater Catchment

Association. Maintenance tasks must be documented and substantially comply with the maintenance responsibilities outlined in the declaration of covenants.

**Table 3-7 Typical Maintenance Tasks for Rainwater Harvesting Systems**

Responsible Person	Frequency	Activity
Owner	Four times a year	Inspect and clean prescreening devices and first flush diverters
	Twice a year	Keep gutters and downspouts free of leaves and other debris
	Once a year	<ul style="list-style-type: none"> <li>▪ Inspect and clean storage cistern lids, paying special attention to vents and screens on inflow and outflow spigots. Check mosquito screens and patch holes or gaps immediately</li> <li>▪ Inspect condition of overflow pipes, overflow filter path, and/or secondary stormwater treatment practices</li> </ul>
	Every third year	Clear overhanging vegetation and trees over roof surface
Qualified Third-Party Inspector	According to Manufacturer	Inspect water quality devices
	As indicated in Appendix N - Rainwater Harvesting Treatment and Management Requirements	Field verification and data logs must be available at all times and semiannual reports must be uploaded to the SW database annually.
	Every third year	<ul style="list-style-type: none"> <li>▪ Inspect cistern for sediment buildup</li> <li>▪ Check integrity of backflow preventer</li> <li>▪ Inspect structural integrity of cistern, pump, pipe and electrical system</li> <li>▪ Replace damaged or defective system components</li> </ul>

**Mosquitoes.** In some situations, poorly designed rainwater harvesting systems can create habitat suitable for mosquito breeding. Designers must provide screens on above- and below-ground cisterns to prevent mosquitoes and other insects from entering the cisterns. If screening is not sufficient in deterring mosquitoes, dunks or pellets containing larvicide can be added to cisterns when water is intended for landscaping use.

**Cold Climate Considerations.** Rainwater harvesting systems have a number of components that can be impacted by freezing temperatures. Designers should give careful consideration to these conditions to prevent system damage and costly repairs.

For above-ground systems, wintertime operation may be more challenging, depending on cistern size and whether heat tape is used on piping. If not protected from freezing, these rainwater harvesting systems must be taken offline for the winter and stormwater treatment values may not be granted for the practice during that off-line period. At the start of the winter season, vulnerable above-ground systems that have not been designed to incorporate special precautions should be disconnected and drained. It may be possible to reconnect former roof leader systems for the winter.

For underground and indoor systems, downspouts and overflow components should be checked for ice blockages during snowmelt events.



**Declaration of Covenants.** A declaration of covenants is required that includes all maintenance responsibilities to ensure the continued stormwater performance for the BMP. The declaration of covenants specifies the property owner's primary maintenance responsibilities, and authorizes DOEE staff to access the property for inspection or corrective action in the event the proper maintenance is not performed. The declaration of covenants is recorded in the District of Columbia land records. A template form is provided at the end of Chapter 5, "Administration of Stormwater Management Rules" (see Figure 5.11), although variations will exist for situations in which stormwater crosses property lines. The covenant is between the property owner and the Government of the District of Columbia. It is submitted through the Office of the Attorney General. All SWMPs have a maintenance agreement stamp that must be signed for a building permit to be issued. A maintenance schedule must appear on the SWMP. Additionally, a maintenance schedule is required to be included as an exhibit to the declaration of covenants.

Covenants are not required on government properties, but maintenance responsibilities must be either signed by the Responsible Person for Maintenance on a partnership agreement or be identified in a memorandum of understanding that is incorporated into the plan submission.

**Waste Material.** Waste material from the repair, maintenance, or removal of a BMP or land cover shall be removed and disposed of in compliance with applicable federal and District law.

### 3.3.8 Rainwater Harvesting: Stormwater Compliance Calculations

Rainwater harvesting practices receive a partial retention value for the SWR<sub>v</sub>, which is determined by using the Rainwater Harvesting Storage Volume Calculator, as described in Section 3.3.4, "Rainwater Harvesting Design Criteria." Rainwater harvesting is not an accepted total suspended solids treatment practice.

Rainwater harvesting practices also contribute to peak flow reduction. This contribution can be determined in several ways. One method is to subtract the Retention Value from the total runoff volume for the 2-year, 15-year, and 100-year storms. The resulting reduced runoff volumes can then be used to calculate a reduced NRCS CN for the site or SDA. The reduced NRCS CN can then be used to calculate peak flow rates for the various storm events. Other hydrologic modeling tools that employ different procedures may be used as well.

### 3.3.9 References

Cabell Brand Center. 2007. Virginia Rainwater Harvesting Manual. Salem, VA.  
<http://www.cabellbrandcenter.org>

Cabell Brand Center. 2009. Virginia Rainwater Harvesting Manual, Version 2.0. Salem, VA.  
<http://www.cabellbrandcenter.org/publications>

NSF International. NSF P151: Certification of Rainwater Catchment System Components. 2014.  
[https://www.nsf.org/newsroom\\_pdf/water\\_rainwater\\_catchment.pdf](https://www.nsf.org/newsroom_pdf/water_rainwater_catchment.pdf)

National Oceanic and Atmospheric Administration (NOAA). 2004. NOAA Atlas 14  
Precipitation-Frequency Atlas of the United States, Volume 2, Version 3.0. Revised 2006.  
Silver Spring, MD.

Sharvelle, S.; Ashbolt, N.; Clerico, E.; Hultquist, R.; Leverenz, H.; and Olivieri, A. (2017). Risk-Based Framework for the Development of Public Health Guidance for Decentralized Non-Potable Water Systems. Prepared by the National Water Research Institute for the Water Environment & Reuse Foundation. Alexandria, VA WE&RF Project NoSIWM10C15.

Texas Water Development Board (TWDB). 2005. The Texas Manual on Rainwater Harvesting. Third Ed. Austin, TX.

## 3.4 Impervious Surface Disconnection

**Definition.** This strategy involves managing runoff close to its source by directing it from rooftops and other impervious surfaces to pervious areas. Disconnection practices can be used to reduce the volume of runoff that enters the combined or separate sewer systems. Applicable practices include the following:

- D-1 Simple disconnection to pervious areas with the compacted cover designation
- D-2 Simple disconnection to conservation areas with the natural cover designation
- D-3 Simple disconnection to a soil compost amended filter path

Disconnection practices reduce a portion of the SWRV. In order to meet requirements for larger storm events, disconnection practices must be combined with additional practices.

### 3.4.1 Impervious Surface Disconnection Feasibility Criteria

Impervious surface disconnections are ideal for use on commercial, institutional, municipal, multi-family residential, and single-family residential buildings. Key constraints with impervious surface disconnections include available space, soil permeability, and soil compaction. Figure 3.12 illustrates some of these constraints. These and other feasibility criteria are described below and summarized in Table 3-8.

- **Contributing Drainage Area.** For rooftop impervious areas, the maximum impervious area treated cannot exceed 1,000 square feet per disconnection. For impervious areas other than rooftop, the longest contributing impervious area flow path cannot exceed 75 feet.
- **Required Space.** Minimum 150 square feet of disconnection area.
- **Sizing.** The available disconnection area must be at least 10 feet wide and 15 feet long. The disconnection width is limited to 25 feet unless the contributing runoff is conveyed via sheetflow or a level spreader. The disconnection length can be extended up to 100 feet to increase the retention value.
- **Site Topography.** Simple disconnection is best applied when the grade of the receiving pervious area is less than 2%, or less than 5% with turf reinforcement. The slope of the receiving areas must be graded away from any building foundations. Turf reinforcement may include erosion control matting or other appropriate reinforcing materials that are confirmed by the designer to be erosion resistant for the specific characteristics and flow rates anticipated at each individual application, and acceptable to the plan-approving authority.
- **Soils.** Impervious surface disconnection can be used on any post-construction hydrologic soil group (HSG). The disconnection area must be kept well-vegetated with minimal bare spots—at least 95% soil cover (see DOEE’s Erosion and Sediment Control Manual, Section 2.10 Vegetative Stabilization, <https://doee.dc.gov/node/619312>).
- **Building Setbacks.** If the grade of the receiving area is less than 1%, downspouts must be extended 5 feet away from building.

**Table 3-8 Feasibility Criteria for Simple Disconnection**

Design Factor	Disconnection Design
Contributing Drainage Area	1,000 square feet per rooftop disconnection. For impervious areas other than rooftop, the longest contributing impervious area flow path cannot exceed 75 feet.
Required Space	Minimum 150 square feet of disconnection area.
Sizing	The available disconnection area must be at least 10 feet wide and 15 feet long. Maximum disconnection width is 25 feet unless the contributing runoff is conveyed via sheetflow or a level spreader. Maximum disconnection length is 100 feet.
Site Topography	Grade of the receiving pervious area is less than 2%, or less than 5% with turf reinforcement. The slope of the receiving areas must be graded away from any building foundations.
Soils	Impervious surface disconnection can be used on any post-construction HSG. The disconnection area must be kept well-vegetated with minimal bare spots.
Building Setbacks	5 feet away from building if the grade of the receiving area is less than 1%.

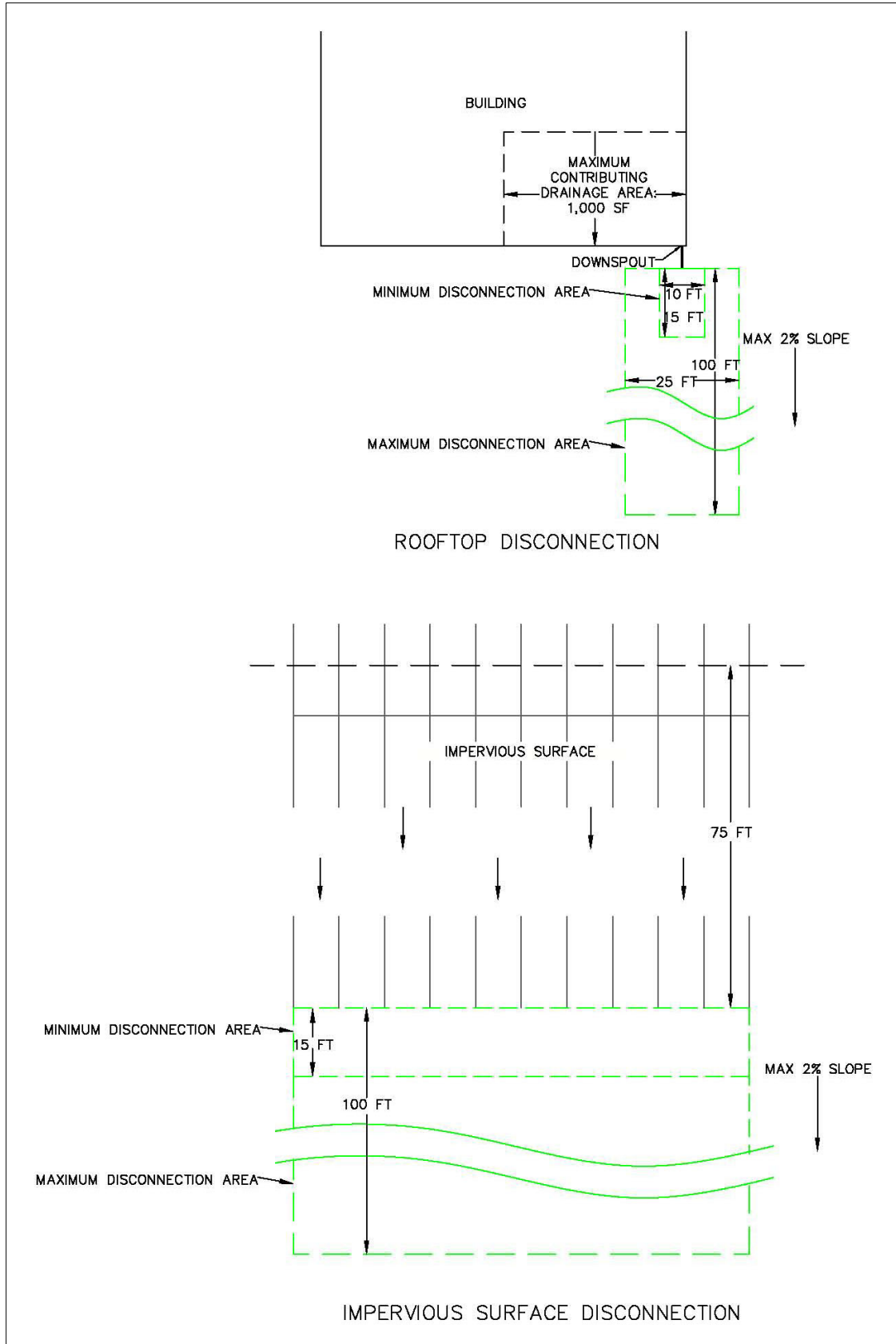


Figure 3.12 Design requirements for rooftop and impervious surfaces.

### **3.4.2 Impervious Surface Disconnection Conveyance Criteria**

Receiving areas in simple disconnection practices (D-1, D-2, and D-3) require a design that safely conveys the 2-year and 15-year storm events over the receiving area without causing erosion. In some applications, erosion control matting or other appropriate reinforcing materials may be needed to control flow rates anticipated for these larger design storms.

### **3.4.3 Impervious Surface Disconnection Pretreatment Criteria**

Pretreatment is not needed for simple impervious surface disconnection.

### **3.4.4 Impervious Surface Disconnection Design Criteria**

The following design criteria apply to each disconnection practice:

**(D-1) Simple Disconnection to a Pervious Area with the Compacted Cover Designation.** Disconnection to pervious areas with the compacted cover designation is required to meet the feasibility criteria presented above in Section 3.4.1, “Impervious Surface Disconnection Feasibility Criteria.”

During site construction, care must be taken not to compact the receiving pervious area. To prevent soil compaction, heavy vehicular and foot traffic must be kept out of the receiving pervious area both during and after construction. This can be accomplished by clearly delineating the receiving pervious areas on all development plans and protecting them with temporary fencing prior to the start of land-disturbing activities (see Appendix O - Land Cover Designations for guidance on protecting natural and compacted cover designations during construction). If compaction occurs, soil amendments or post-construction aeration will be required (see Appendix K - Soil Compost Amendment Requirements).

**(D-2) Simple Disconnection to a Conservation Area with Natural Cover Designation.** Disconnection to conservation areas is required to meet the feasibility criteria presented in Section 3.4.1, “Impervious Surface Disconnection Feasibility Criteria,” with the following additions/exceptions:

- Minimum disconnection length is 40 feet.
- Disconnection area cannot include regulated wetlands and buffer areas.
- Inflow must be conveyed via sheet flow or via a level spreader.
- If inflow is conveyed via sheet flow, the maximum flow path is 75 feet when the runoff is conveyed from an impervious area.
- If inflow is conveyed via a level spreader, the maximum flow path is 150 feet, and the level spreader must be designed with an appropriate width as specified below.
- Retention value applies only to areas directly receiving sheet flow or directly perpendicular to the level spreader.

A level spreader can be used to disperse or “spread” concentrated flow thinly over a vegetated or forested area to promote greater runoff infiltration in the receiving area. A level spreader consists

of a permanent linear structure constructed at a 0% grade that transects the slope. The influent concentrated runoff must be spread over an area wide enough area so that erosion of the receiving area does not result. Detailed information on the design and function of level spreaders can be found in Hathaway and Hunt (2006) and NCDWQ (2010).

The minimum required width of the level spreader is

- 13 linear feet per each 1 cubic foot/second of inflow if the receiving conservation area (natural cover designation) has a minimum 90% ground cover
- 40 linear feet per 1 cubic foot/second of inflow if the receiving conservation area (natural cover designation) is forested

**(D-3) Simple Disconnection to a Soil Compost-Amended Filter Path.** Consult Appendix K - Soil Compost Amendment Requirements for detailed information on the design and function of soil compost amendments. The incorporation of compost amendments must meet the design criteria in the specification and include the following design elements:

- Flow from the downspout must spread over a 10-foot-wide strip extending down-gradient along the flow path from the building to the street or conveyance system.
- The filter path must be a minimum 15 feet in length.
- Installation of a pea gravel or river stone diaphragm, or other accepted flow-spreading device, is required at the downspout outlet to distribute flows evenly across the filter path.
- The strip requires adequate freeboard so that flow remains within the strip and is not diverted away from the strip. In general, this means that the strip should be lower than the surrounding land area in order to keep flow in the filter path. Similarly, the flow area of the filter strip must be level to discourage concentrating the flow down the middle of the filter path.
- Use 2 to 4 inches of compost and till to a depth of 6 to 10 inches within the filter path.

### 3.4.5 Impervious Surface Disconnection Landscaping Criteria

All receiving disconnection areas must be stabilized to prevent erosion or transport of sediment to receiving practices or drainage systems. Several appropriate types of grasses for disconnection practices are listed in Table 3-9. Designers must ensure that the maximum flow velocities do not exceed the values listed in the table for the selected grass species and the specific site slope. If using vegetation outside of this table, the designer must provide documentation to ensure excessive erosion will not occur. Additionally, see the DOEE Erosion and Sediment Control Manual Section 2.10 Vegetative Stabilization for vegetation suggestions (<https://doee.dc.gov/node/619312>).

**Table 3-9 Recommended Vegetation for Pervious Disconnection Areas**

Vegetation Type	Slope (%)	Maximum Velocity (ft/s)	
		Erosion resistant soil	Easily Eroded Soil
Bermuda Grass	< 5	8	6
	5–10	7	5
	> 10	6	4
Kentucky Bluegrass	< 5	7	5
	5–10	6	4
	> 10	5	3
Tall Fescue Grass Mixture	< 5	6	4
	5–10	4	3
Annual and Perennial Rye	0–5	4	3
Sod	0–5	4	3

Source: USDA, TP-61, 1954; City of Roanoke Virginia Stormwater Design Manual, 2008.

### 3.4.6 Impervious Surface Disconnection Construction Sequence

**Construction Sequence for Disconnection to Pervious Areas.** For simple disconnection to a pervious area, the pervious area can be within the limits of disturbance (LOD) during construction. The following procedures should be followed during construction:

- Before site work begins, the receiving pervious disconnection area boundaries should be clearly marked.
- Construction traffic in the disconnection area should be limited to avoid compaction. The material stockpile area shall not be located in the disconnection area.
- Construction runoff should be directed away from the proposed disconnection area, using perimeter silt fence, or, preferably, a diversion dike.
- If existing topsoil is stripped during grading, it shall be stockpiled for later use.
- The disconnection area may require light grading to achieve desired elevations and slopes. This should be done with tracked vehicles to prevent compaction.
- Topsoil and or compost amendments should be incorporated evenly across the disconnection area, stabilized with seed, and protected by biodegradable erosion control matting or blankets.
- Stormwater must not be diverted into any compost amended areas until the area is stabilized, which is defined as having groundcover of 95% or greater by the DOEE Erosion and Sediment Control Manual Section 2.10 Vegetative Stabilization (<https://doee.dc.gov/node/619312>).

**Construction Sequence for Disconnection to Conservation Areas with Natural Cover Designation.** For simple disconnection to a conservation area, the conservation area must be



fully protected during the construction stage of development and kept outside the LOD on the soil erosion and sediment control plan.

- No staging, parking, clearing, grading, or heavy equipment access is allowed in the conservation area except temporary disturbances associated with incidental utility construction, restoration operations, or management of nuisance vegetation. Incidental utility construction includes protecting existing utilities, removing abandoned utilities, rearranging service lines, temporarily rearranging utilities, and adjusting utility appurtenances.
- Any conservation areas shall be protected by super silt fence, chain link fence, orange safety fence, or other measures to prevent sediment discharge consistent with the DOEE Erosion and Sediment Control standards and specifications as posted on DOEE’s website at <https://doee.dc.gov/esc>.
- The LOD must be clearly shown on all construction drawings and identified and protected in the field by acceptable signage, silt fence, snow fence, or other protective barrier.
- If a level spreader is to be used in the design, construction of the level spreader shall not commence until the CDA has been stabilized and perimeter soil erosion and sediment control measures have been removed and cleaned out. Stormwater must not be diverted into the disconnection area until the level spreader is installed and stabilized.

**Construction Supervision.** Construction supervision is recommended to ensure compliance with design standards. A qualified professional should evaluate the performance of the disconnection after the first significant rainfall event to look for evidence of gullies, outflanking, undercutting, or sparse vegetative cover. Spot repairs should be made as needed.

DOEE’s construction phase inspection checklist for impervious cover disconnection can be found in Appendix L - Construction Inspection Checklists.

### 3.4.7 Impervious Surface Disconnection Maintenance Criteria

Maintenance of disconnected downspouts usually involves regular lawn or landscaping maintenance in the filter path from the roof to the street. In some cases, runoff from a simple disconnection may be directed to a more natural, undisturbed setting (i.e., where lot grading and clearing is “fingerprinted” and the proposed filter path is protected). Typical maintenance activities include erosion control of the receiving area and ensuring the receiving area remains uncompacted and pervious.

DOEE’s maintenance inspection checklists for disconnection can be found in Appendix M - Maintenance Inspection Checklists.

**Declaration of Covenants.** A declaration of covenants is required that includes all maintenance responsibilities to ensure the continued stormwater performance for the BMP. The declaration of covenants specifies the property owner’s primary maintenance responsibilities, and authorizes DOEE staff to access the property for inspection or corrective action in the event the proper maintenance is not performed. The declaration of covenants is recorded in the District of Columbia land records. A template form is provided at the end of Chapter 5, “Administration of Stormwater Management Rules” (see Figure 5.11), although variations will exist for situations in

which stormwater crosses property lines. The covenant is between the property owner and the Government of the District of Columbia. It is submitted through the Office of the Attorney General. All SWMPs have a maintenance agreement stamp that must be signed for a building permit to be issued. A maintenance schedule must appear on the SWMP. Additionally, a maintenance schedule is required to be included as an exhibit to the declaration of covenants.

Covenants are not required on government properties, but maintenance responsibilities must be either signed by the Responsible Person for Maintenance on a partnership agreement or be identified in a memorandum of understanding that is incorporated into the plan submission.

**Waste Material.** Waste material from the repair, maintenance, or removal of a BMP or land cover shall be removed and disposed of in compliance with applicable federal and District law.

### 3.4.8 Impervious Surface Disconnection Stormwater Compliance Calculations

Disconnection practices receive the following retention values:

- D-1 (A/B) Simple disconnection to a pervious compacted cover area on HSG A or B soils: retention value of 4 cubic feet (30 gallons) per 100 square feet of receiving pervious area (compacted cover).
- D-1 (C/D) Simple disconnection to a pervious compacted cover area on C or D Soils: retention value of 2 cubic feet (15 gallons) per 100 square feet of receiving pervious area (compacted cover).
- D-2 Simple disconnection to a conserved natural cover area: retention value of 6 cubic feet (45 gallons) per 100 square feet of receiving pervious conservation area (natural cover).
- D-3 Simple disconnection to a soil compost amended filter path: retention value of 4 cubic (30 gallons) feet per 100 square feet of receiving pervious conservation area (soil amended).

Note: The surface areas for practices D-1 and D-3 are considered compacted cover for purposes of retention calculations, and the surface area of practice D-2 is considered natural cover.

Simple disconnection practices are not accepted as total suspended solids (TSS) treatment practices (see Table 3-10).

**Table 3-10 Disconnection Retention Value and Pollutant Removal**

Type of Simple Disconnection	Retention Value cubic feet (gallons) per 100 ft <sup>2</sup> of pervious receiving area	Accepted TSS Treatment Practice
To a pervious compacted cover area (A/B soils)	4 (30)	No
To a pervious compacted cover area (C/D soils)	2 (15)	No
To a conserved natural cover area	6 (45)	No
To a soil compost amended filter path	4 (30)	No

Impervious surface disconnection also contributes to peak flow reduction. This contribution can be determined in several ways. One method is to subtract the retention value from the total runoff volume for the 2-year, 15-year, and 100-year storms. The resulting reduced runoff volumes can then be used to calculate a reduced NRCS CN for the site or SDA. The reduced NRCS CN can then be used to calculate peak flow rates for the various storm events. Other hydrologic modeling tools that employ different procedures may be used as well.

### 3.4.9 References

City of Roanoke Virginia. 2007. Stormwater Design Manual. Department of Planning and Building and Development. Available online at:

<http://www.roanokeva.gov/1065/Stormwater-Management-Code>

District Department of Transportation (DDOT). Design and Engineering Manual. 2009.

Hathaway, J.M. and Hunt, W.F. 2006. Level Spreaders: Overview, Design, and Maintenance. Urban Waterways Design Series. North Carolina Cooperative Extension Service. Raleigh, NC. Available online:

<http://chesapeakestormwater.net/wp-content/uploads/downloads/2012/01/LevelSpreaders2006.pdf>

North Carolina Division of Water Quality (NCDWQ). 2010. Level Spreader-Vegetated Filter Strip System. Stormwater Best Practices Manual. Raleigh, NC.

[http://portal.ncdenr.org/c/document\\_library/get\\_file?uuid=5d698f00-caaa-4f64-ac1f-d1561b4fd53d&groupId=38364](http://portal.ncdenr.org/c/document_library/get_file?uuid=5d698f00-caaa-4f64-ac1f-d1561b4fd53d&groupId=38364)

United States Department of Agriculture (USDA). 1954. Handbook of channel design for soil and water conservation. SCS-TP-61. Washington, DC. Available online:

[http://www.nrcs.usda.gov/Internet/FSE\\_DOCUMENTS/stelprdb1044529.pdf](http://www.nrcs.usda.gov/Internet/FSE_DOCUMENTS/stelprdb1044529.pdf)

Virginia DCR Stormwater Design Specification No. 1: Rooftop (Impervious Surface) Disconnection Version 1.8. 2010.

### 3.5 Permeable Pavement Systems

**Definition.** This is a paving system that captures and temporarily stores the SWRv by filtering runoff through voids in an alternative pavement surface into an underlying stone reservoir. Filtered runoff may be collected and returned to the conveyance system or allowed to partially (or fully) infiltrate into the soil.

Design variants include the following:

- P-1 Porous asphalt (PA)
- P-2 Pervious concrete (PC)
- P-3 Permeable pavers (PP)

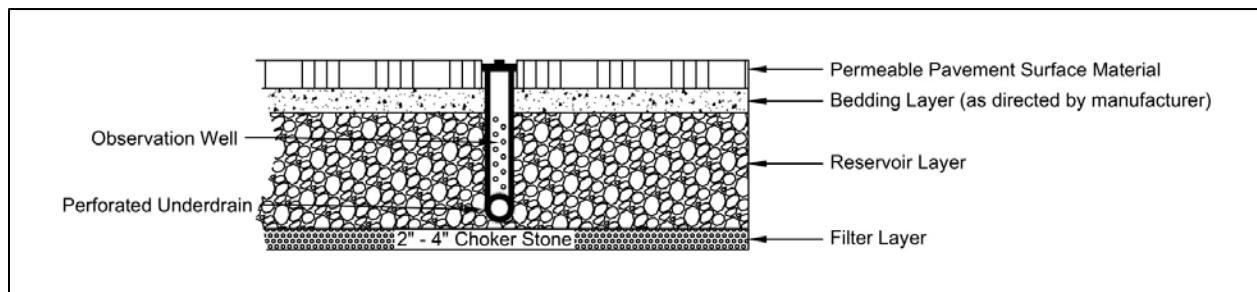
Other surface material variations of permeable pavement that are DOEE-approved and part of a permeable pavement system, such as porous rubber, plastic grid pavers, and synthetic turf systems are also encompassed in this section.

Permeable pavement systems are not typically designed to provide stormwater detention of larger storms (e.g., 2-year, 15-year), but they may be in some circumstances. Permeable pavement practices shall generally be combined with a separate facility to provide those controls.

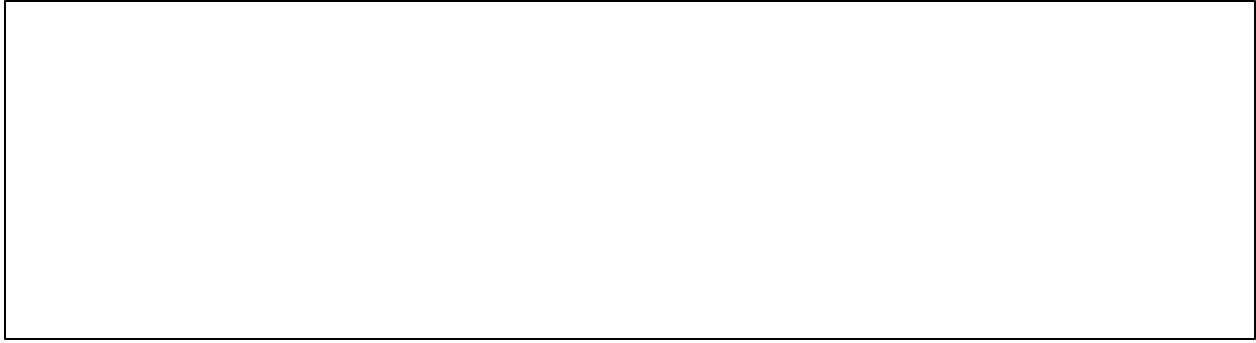
There are two types of permeable pavement design configurations:

- **Standard Design.** Practice with a standard underdrain design and no infiltration sump or water quality filter (see Figure 3.13).
- **Enhanced Design.** Practice with underdrains that contain a water quality filter layer and an infiltration sump beneath the underdrain sized to drain the design storm in 48 hours (see Figure 3.14) or practices with no underdrains that can infiltrate the design storm volume in 48 hours (see Figure 3.15).

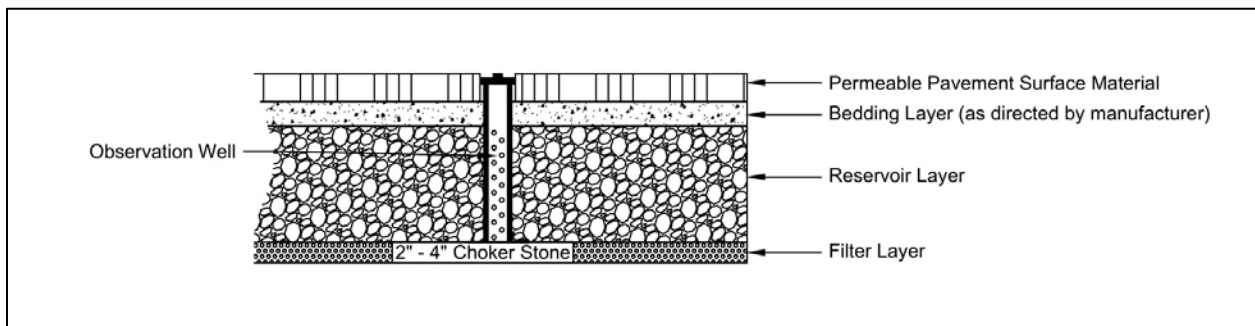
The particular design configuration to be implemented on a site is typically dependent on specific site conditions and the characteristics of the underlying soils. These criteria are further discussed below.



**Figure 3.13 Cross section of a standard permeable pavement design.**



**Figure 3.14** Cross section of an enhanced permeable pavement design with an underdrain.



**Figure 3.15** Cross section of an enhanced standard permeable pavement design without an underdrain.

### 3.5.1 Permeable Pavement Feasibility Criteria

Since permeable pavement has a very high retention capability, it should always be considered as an alternative to conventional pavement. Permeable pavement is subject to the same feasibility constraints as most infiltration practices, as described below.

**Required Space.** A prime advantage of permeable pavement is that it does not normally require additional space at a new development or redevelopment site, which can be important for tight sites or areas where land prices are high.

**Soils.** Soil conditions do not typically constrain the use of permeable pavement, although they do determine whether an underdrain is needed. Underdrains may be required if the measured permeability of the underlying soils is less than 0.5 inch per hour (although utilization of an infiltration sump may still be feasible). When designing an infiltrating permeable pavement practice, designers must verify soil permeability by using the on-site soil investigation methods provided in Appendix P - Geotechnical Information Requirements for Underground BMPs. Impermeable soils will require an underdrain.

In fill soil locations, geotechnical investigations are required to determine if the use of an impermeable liner and underdrain are necessary or if the use of an infiltration sump is permissible (see Section 3.5.4, “Permeable Pavement Design Criteria”).

**Contributing Drainage Area.** The portion of the CDA that does not include the permeable pavement may not exceed 5 times the surface area of the permeable pavement (2 times is recommended), and it should be as close to 100% impervious as possible to reduce sediment loading.

**Pavement Surface Slope.** Steep pavement surface slopes can reduce the stormwater storage capability of permeable pavement and may cause shifting of the pavement surface and base materials. The permeable pavement slope must be less than 5%. In all cases, designs must ensure that the slope of the pavement does not lead to flow occurring out of the stone reservoir layer onto lower portions of the pavement surface.

**Minimum Hydraulic Head.** The elevation difference needed for permeable pavement to function properly is generally nominal, although 1 to 4 feet of head from the pavement surface to the underdrain outlet is typically necessary. This value may vary based on several design factors, such as required storage depth and underdrain location.

**Minimum Depth to Water Table.** A high groundwater table may cause runoff to pond at the bottom of the permeable pavement system. Therefore, a minimum vertical distance of 2 feet must be provided between the bottom of the permeable pavement installation (i.e., the bottom invert of the reservoir layer) and the seasonal high water table.

**Setbacks.** To avoid the risk of seepage, stormwater cannot flow from the permeable pavement reservoir layer to the traditional pavement base layer, existing structure foundations, or an area where there may be future development adjacent to the property line. Setbacks to structures and property lines must be at least 10 feet, and adequate waterproofing protection must be provided for foundations and basements. Where the 10-foot setback is not possible, an impermeable liner may be used along the sides of the permeable pavement practice, extending from the surface to the bottom of the practice.

**Proximity to Utilities.** Interference with underground utilities should be avoided if possible. When large site development is undertaken the expectation of achieving avoidance will be high. Conflicts may be commonplace on smaller sites and in the public right-of-way (PROW). Consult with each utility company on recommended offsets, which will allow utility maintenance work with minimal disturbance to the permeable pavement. For permeable pavement in the public right-of-way (PROW), a consolidated presentation of the various utility offset recommendations can be found in Chapter 28.8.4.4 of the District of Columbia Department of Transportation (DDOT) Design and Engineering Manual. Consult the District of Columbia Water and Sewer Authority (DC Water) Green Infrastructure Utility Protection Guidelines, latest edition, for water and sewer line recommendations. Where conflicts cannot be avoided, follow these guidelines:

- Consider altering the location or sizing of the permeable pavement to avoid or minimize the utility conflict. Consider an alternate BMP type to avoid conflict.

- Use design features to mitigate the impacts of conflicts that may arise by allowing the permeable pavement and the utility to coexist. The permeable pavement design may need to incorporate impervious areas, through geotextiles or compaction, to protect utility crossings.
- Work with the utility company to evaluate the relocation of the existing utility and install the optimum placement and sizing of the permeable pavement.
- If utility functionality, longevity, and vehicular access to manholes can be assured, accept the permeable pavement design and location with the existing utility. Design sufficient soil coverage over the utility or general clearances or other features, such as an impermeable liner, to assure all entities that the conflict is limited to maintenance.

Note: When accepting utility conflict into the permeable pavement location and design, it is understood the permeable pavement will be temporarily impacted during utility work but the utility owner will replace the permeable pavement or, alternatively, install functionally comparable permeable pavement according to the specifications in the current version of this guidebook. Restoration of permeable pavement that is located in the PROW will also conform with the DDOT Design and Engineering Manual, with special attention to Chapter 28 and the Design and Engineering Manual supplements for “Low Impact Development” and “Green Infrastructure Standards and Specifications.”

**Hotspot Land Uses.** Permeable pavements may not be used to treat hotspot runoff. For a list of potential stormwater hotspot operations, consult Appendix Q - Stormwater Hotspots.

On sites with existing contaminated soils, infiltration is not allowed. The sides and bottom of permeable pavement installations must include an impermeable liner, and the enhanced design configuration cannot be used.

**High Loading Situations.** Permeable pavement is not intended to treat sites with high sediment or trash/debris loads, since such loads will cause the practice to clog and fail. Sites with considerable pervious area (e.g., newly established turf and landscaping) can be considered high loading sites and the pervious areas should be diverted if possible from the permeable pavement area. If unavoidable, pretreatment measures, such as a gravel or a sod filter strip should be employed (see Section 3.5.3, “Permeable Pavement Pretreatment Criteria”).

**High Speed Roads.** Permeable pavement should not be used for high speed roads, although it has been successfully applied for low speed residential streets, parking lanes, and roadway shoulders.

### 3.5.2 Permeable Pavement Conveyance Criteria

Permeable pavement designs must include methods to convey larger storms (e.g., 2-year, 15-year) to the storm drain system. Conveyance methods include the following:

- Place an overdrain—a horizontal perforated pipe near the top of the reservoir layer—to pass excess flows after water has filled the base.
- Increase the thickness of the top of the reservoir layer by as much as 6 inches to increase storage (i.e., create freeboard). The design computations used to size the reservoir layer often assume that no freeboard is present.

- Create underground detention within the reservoir layer of the permeable pavement system. Reservoir storage may be augmented by corrugated metal pipes, plastic or concrete arch structures, etc.
- Route overflows to another detention or conveyance system.
- Set the storm drain inlets flush with the elevation of the permeable pavement surface to effectively convey excess stormwater runoff past the system. The design should also make allowances for relief of unacceptable ponding depths during larger rainfall events.

### 3.5.3 Permeable Pavement Pretreatment Criteria

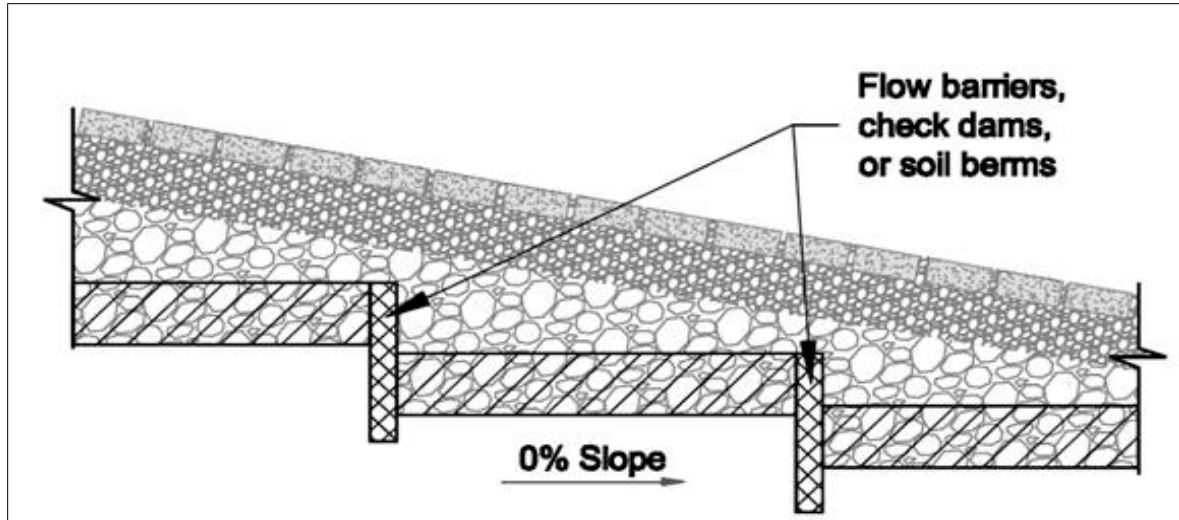
Pretreatment for most permeable pavement applications is not necessary. Additional pretreatment is recommended if the pavement receives runoff from adjacent pervious areas. For example, a gravel or sod filter strip can be placed adjacent to pervious (landscaped) areas to trap coarse sediment particles before they reach the pavement surface in order to reduce clogging.

### 3.5.4 Permeable Pavement Design Criteria

**Type of Surface Pavement.** The type of pavement should be selected based on a review of the pavement specifications and properties and designed according to the product manufacturer's recommendations.

**Pavement Bottom Slope.** For unlined designs, the bottom slope of a permeable pavement installation should be as flat as possible (i.e., 0% longitudinal and lateral slopes) to enable even distribution and infiltration of stormwater. The maximum bottom slope is 2%. On sloped sites, internal check dams or barriers, as shown in Figure 3.16, can be incorporated into the subsurface to encourage infiltration. Barriers may be constructed of concrete, earthen berms, impermeable membranes, or low permeability geotextile (See Drawing No. 621.11 and 621.64 in the DDOT Green Infrastructure Standards for more details). In this type of design, the depth of the infiltration sump would be the depth behind the check dams. The depth and spacing of the barriers is dependent upon the underlying slope and the saturated hydraulic conductivity, as any water retained by the flow barriers must infiltrate within 48 hours. If an underdrain will be used in conjunction with the flow barriers, it can be installed over the top of the barriers, or parallel to the barriers with an underdrain in each cell.





**Figure 3.16** Use of flow barriers to encourage infiltration on sloped sites.

#### Internal Geometry and Drawdowns.

- **Rapid Drawdown.** Permeable pavement must be designed so that the target storage volume is detained in the reservoir for as long as possible, 36 to 48 hours, before completely discharging through an underdrain. A minimum orifice size of 1 inch is recommended regardless of the calculated drawdown time.

Note: A 48-hour maximum drawdown time is utilized for permeable pavement rather than the 72-hour value used for other BMPs. This shorter drawdown time, in accordance with industry standards, is intended to ensure that the subgrade does not stay saturated for too long and cause problems with the pavement.

- **Infiltration Sump.** To promote greater retention for permeable pavement located on marginal soils, an infiltration sump can be installed to create a storage layer below the underdrain invert. This design configuration is discussed further below.

**Reservoir Layer.** The reservoir layer consists of the stone underneath the pavement section and above the bottom filter layer or underlying soils, including the optional infiltration sump. The total thickness of the reservoir layer is determined by runoff storage needs, the saturated hydraulic conductivity of in-situ soils, structural requirements of the pavement sub-base, depth to water table and bedrock, and frost depth conditions (see Section 3.5.1, “Permeable Pavement Feasibility Criteria”). A geotechnical engineer should be consulted regarding the suitability of the soil subgrade.

- The reservoir below the permeable pavement surface should be composed of stone aggregate washed clean and free of fines and sized for both the storm event to be treated and the structural requirements of the expected traffic loading. Additional chamber structures may also be used to create larger storage volumes.

- The storage layer may consist of No. 57 stone washed clean and free of fines, although No. 2 stone is preferred because it provides additional structural stability. Other appropriate materials may be used if accepted by DOEE.
- The bottom of the reservoir layer should be completely flat so that runoff will be able to infiltrate evenly through the entire surface. The use of terracing and check dams is permissible.

**Underdrains.** Most permeable pavement designs will require an underdrain (see Section 3.5.1, “Permeable Pavement Feasibility Criteria”). Underdrains can also be used to keep detained stormwater from flooding permeable pavement during extreme rain events. Multiple underdrains are typically necessary for permeable pavement wider than 40 feet, and each underdrain is recommended to be located 20 feet or less from the next pipe or the edge of the permeable pavement. For long and narrow applications, a single underdrain running the length of the permeable pavement is sufficient. The underdrain should be perforated schedule 40 PVC pipe (corrugated high density propylene (HDPE) may be used for smaller load-bearing applications), with three or four rows of 3/8-inch perforations at 6 inches on center. The underdrain must be encased in a layer of No. 57 stone washed clean and free of fines, with a minimum 2-inch cover over the top of the underdrain and a maximum of 2 inches of stone below the underdrain. The underdrain system must include a flow control device to ensure that the reservoir layer drains slowly (within 36 to 48 hours).

- The underdrain outlet can be fitted with a flow-reduction orifice within a weir or some other easily inspected and maintained configuration in the downstream manhole as a means of regulating the stormwater detention time. The minimum diameter of any orifice is one (1) inch. The designer should verify that the volume will draw down completely within 36 to 48 hours.
- On infiltration designs, an underdrain(s) can be installed and capped at the downstream structure as an option for future use if maintenance observations indicate a reduction in the soil permeability.

**Observation Wells.** All permeable pavement practices must include observation wells. The observation well is used to observe the rate of drawdown within the reservoir layer following a storm event and to facilitate periodic inspection and maintenance. The observation well should consist of a well-anchored, perforated 4- to 6-inch diameter PVC pipe. Perforations should only be in the reservoir layer. If the permeable pavement has an underdrain, tie the observation well into any T or Y connections in the underdrain system. The observation well should extend vertically to the bottom of the reservoir layer and extend upwards to be flush with the surface (or just under pavers) with a lockable cap.

**Infiltration Sump (optional, required for underdrained Enhanced Design).** For unlined permeable pavement systems, an optional upturned elbow or elevated underdrain configuration can be used to promote greater retention for permeable pavement located on marginal soils (see Figure 3.13). The infiltration sump must be installed to create a storage layer below the underdrain or upturned elbow invert. The depth of this layer must be sized so that the design storm can infiltrate into the subsoils in a 48-hour period. The bottom of the infiltration sump must be at least 2 feet above the seasonally high water table. The inclusion of an infiltration

sump is not permitted for designs with an impermeable liner. In fill soil locations, geotechnical investigations are required to determine if the use of an infiltration sump is permissible.

In order to improve the infiltration rate of the sump, it may be designed as a series of 1-foot-wide trenches spread 5 feet apart, which are excavated after compaction of the existing soils is performed. Excavation of these trenches may allow access to less compacted, higher permeability soils and improve the effectiveness of the infiltration sump (Brown and Hunt, 2009). Regardless of the infiltration sump design, the saturated hydraulic conductivity must be field verified.

**Filter Layer (optional).** To protect the bottom of the reservoir layer from intrusion by underlying soils, a filter layer can be used. The underlying native soils should be separated from the stone reservoir by a 2- to 4-inch layer of choker stone (e.g., No. 8).

**Geotextile (optional).** Geotextile fabric is another option to protect the bottom of the reservoir layer from intrusion by underlying soils, although some practitioners recommend avoiding the use of fabric beneath permeable pavements since it may become a future plane of clogging within the system. Geotextile fabric is still recommended to protect the excavated sides of the reservoir layer, in order to prevent soil piping. An appropriate geotextile fabric that complies with AASHTO M-288 Class 2, requirements and has a permeability of at least an order of magnitude (10 times) higher than the soil subgrade permeability must be used.

**Impermeable Liner.** An impermeable liner is not typically required, although it may be utilized in fill applications where deemed necessary by a geotechnical investigation, on sites with contaminated soils, or on the sides of the practice to protect adjacent structures from seepage. Use a PVC geomembrane liner or equivalent material of an appropriate thickness (follow manufacturer's instructions for installation). Field seams must be sealed according to the liner manufacturer's specifications. A minimum 6-inch overlap of material is required at all seams.

**Material Specifications.** Permeable pavement material specifications vary according to the specific pavement product selected. A general comparison of different permeable pavements is provided in Table 3-11, but designers should consult manufacturer's technical specifications for specific criteria and guidance. Table 3-12 provides general material specifications for the component structures installed beneath the permeable pavement. Note that the size of stone materials used in the reservoir and filter layers may differ depending on the type of surface material.

**Table 3-11 Permeable Pavement Specifications for a Variety of Typical Surface Materials**

Material	Specification	Notes
Permeable Pavers (PP)	Void content, thickness, and compressive strength vary based on type and manufacturer  Open void fill media: aggregate, topsoil and grass, coarse sand, etc.	Reservoir layer required to support the structural load.
Pervious Concrete (PC)	Void content: 15–20% Thickness: Typically 4–8 inches Compressive strength: 2.8–28 MPa Open void fill media: None	May not require a reservoir layer to support the structural load, but a layer may be included to increase the storage or infiltration.
Porous Asphalt (PA)	Void content: 15–20% Thickness: Typically 3–7 inches (depending on traffic load) Open void fill media: None	Reservoir layer required to support the structural load.

**Table 3-12 Material Specifications for Typical Layers Beneath the Pavement Surface**

Material	Specification	Notes
Bedding Layer	PC: 3–4 inches of No. 57 stone if No. 2 stone is used for Reservoir Layer PA: 3–4 inches of No. 57 stone PP: Follow manufacturer specifications	ASTM D448 size No. 57 stone (i.e., 1/2 to 1-1/2 inches in size). Must be washed clean and free of fines (no more than 2% passing the No. 200 sieve)
Reservoir Layer	PC: No. 57 stone or No. 2 stone PA: No. 2 stone PP: Follow manufacturer specifications	ASTM D448 size No. 57 stone; No. 2 Stone (i.e., 3/4 to 3 inches in size). Depth is based on the pavement structural and hydraulic requirements. Must be washed clean and free of fines. Other appropriate materials may be used if accepted by DOEE.
Underdrain	Use 4- to 6-inch diameter perforated PVC pipe (or equivalent corrugated HDPE may be used for smaller load-bearing applications), with 3 or 4 rows of 3/8-inch perforations at 6 inches on center. Perforated pipe installed for the full length of the permeable pavement cell, and non-perforated pipe, as needed, used to connect with the storm drain system. T's and Y's should be installed as needed, depending on the underdrain configuration. Extend cleanout pipes to the surface.	
Infiltration Sump (optional)	An aggregate storage layer below the underdrain invert. The material specifications are the same as Reservoir Layer.	
Filter Layer (optional)	The underlying native soils should be separated from the stone reservoir by a 2- to 4-inch layer of choker stone (e.g., No. 8).	
Geotextile (optional)	Use an appropriate geotextile fabric for both sides and/or bottom that complies with AASHTO M-288 Class 2 requirements and has a permeability of at least an order of magnitude (10 times) higher than the soil subgrade permeability. Low-permeability geotextile fabric may be used as a check dam material.	
Impermeable Liner (optional)	Where appropriate, use PVC geomembrane liner or equivalent.	
Observation Well	Use a perforated 4- to 6-inch vertical PVC pipe (AASHTO M-252) with a lockable cap, installed flush with the surface.	

**Permeable Pavement Sizing.** The thickness of the reservoir layer is determined by both a structural and hydraulic design analysis. The reservoir layer serves to retain stormwater and also supports the design traffic loads for the pavement. Permeable pavement structural and hydraulic sizing criteria are discussed below.

**Structural Design.** If permeable pavement will be used in a parking lot or other setting that involves vehicles, the pavement surface must be able to support the maximum anticipated traffic load. The structural design process will vary according to the type of pavement selected, and the manufacturer's specific recommendations should be consulted. The thickness of the permeable pavement and reservoir layer must be sized to support structural loads and to temporarily store the design storm volume (i.e., the water quality, channel protection, and flood control volumes). On most new development and redevelopment sites, the structural support requirements will dictate the depth of the underlying stone reservoir.

The structural design of permeable pavements involves consideration of four main site elements:

- Total traffic
- In situ soil strength
- Environmental elements
- Bedding and reservoir layer design

The resulting structural requirements may include the thickness of the pavement, filter, and reservoir layer. Designers should note that if the underlying soils have a low California Bearing Ratio (less than 4%), they may need to be compacted to at least 95% of the Standard Proctor Density, which may limit their use for infiltration (ASTM, 2009).

Designers should determine structural design requirements by consulting transportation design guidance sources, such as the following:

- AASHTO Guide for Design of Pavement Structures (1993)
- AASHTO Supplement to the Guide for Design of Pavement Structures (1998)

**Hydraulic Design.** Permeable pavement must be sized to store the SWR<sub>v</sub> or larger design storm volumes in the reservoir layer. The storage volume in the pavements must account for the underlying saturated hydraulic conductivity and outflow through any underdrains. The design storm should be routed through the pavement to accurately determine the required reservoir depth. The minimum depth of the reservoir layer needed to store the design storm can be determined by using Equation 3.2.

**Equation 3.2 Reservoir Layer Minimum Depth**

$$d_p = \frac{\left(\frac{P \times Rv \times CDA}{A_p}\right) - (K_{sat} \times t_f)}{\eta_r}$$

where:

- $d_p$  = minimum depth of the reservoir layer (ft)
- $P$  = rainfall depth for the SWRv or other design storm (ft)
- $Rv$  = 0.95 (runoff coefficient of the CDA)
- $CDA$  = total contributing drainage area, including permeable pavement surface area (ft<sup>2</sup>)
- $A_p$  = permeable pavement surface area (ft<sup>2</sup>)
- $K_{sat}$  = field-verified saturated hydraulic conductivity for the subgrade soils (ft/day).  
If an impermeable liner is used in the design, then  $K_{sat} = 0$ .
- $t_f$  = time to fill the reservoir layer (day) (assume 2 hours or 0.083 day)
- $\eta_r$  = 0.4 (effective porosity for the reservoir layer)

This equation makes the following design assumptions:

- If the subgrade will be compacted to meet structural design requirements of the pavement section, the measured saturated hydraulic conductivity shall be based on measurement of the subgrade soil subjected to the compaction requirements.
- The porosity ( $\eta_r$ ) for No. 57 stone is 0.4.

The depth of the reservoir layer cannot be less than the depth required to meet the pavement structural requirement. The depth of the reservoir layer may need to be increased to meet structural or larger storage requirements.

Designers must ensure that the captured volume in standard designs will drain from the pavement in 36 to 48 hours. For infiltration designs without underdrains or designs with infiltration sumps, can be used to determine the drawdown time in the reservoir layer or infiltration sump. The maximum drawdown time is 48 hours.

**Equation 3.3 Drawdown Time**

$$t_d = \frac{d_p \times \eta_r}{K_{sat}}$$

where:

$t_d$	=	drawdown time (days)
$d_p$	=	depth of the reservoir layer (for designs without underdrains) or the depth of the infiltration sump (for Enhanced Designs with underdrains) (ft)
$\eta_r$	=	0.4 (effective porosity for the reservoir layer)
$K_{sat}$	=	field-verified saturated hydraulic conductivity for the subgrade soils (ft/day). If an impermeable liner is used in the design, then $K_{sat} = 0$ .

For designs with underdrains, the drawdown time should be determined using the hydrologic routing or modeling procedures used for detention systems with the depth and head adjusted for the porosity of the aggregate. For more information on orifice design equations, see Appendix H - Design of Flow Control Structures.

The total storage volume provided by the practice,  $S_v$ , should be determined using Equation 3.4.

#### Equation 3.4 Permeable Pavement Storage Volume

$$S_v = A_p [(d_p \times \eta_r) + K_{sat} \times t_f]$$

where:

$S_v$	=	storage volume (ft <sup>3</sup> )
$d_p$	=	depth of the reservoir layer (ft)
$\eta_r$	=	0.4 (effective porosity for the reservoir layer)
$A_p$	=	permeable pavement surface area (ft <sup>2</sup> )
$K_{sat}$	=	field-verified saturated hydraulic conductivity for the subgrade soils (ft/day). If an impermeable liner is used in the design, then $K_{sat} = 0$ .
$t_f$	=	time to fill the reservoir layer (days) (assume 2 hours or 0.083 days)

**Detention Storage Design.** Permeable pavement can also be designed to address, in whole or in part, the detention storage needed to comply with channel protection and/or flood control requirements. The designer can model various approaches by factoring in storage within the stone aggregate layer (including chamber structures that increase the available storage volume), expected infiltration, and any outlet structures used as part of the design. Routing calculations can also be used to provide a more accurate solution of the peak discharge and required storage volume.

Once runoff passes through the surface of the permeable pavement system, designers should calculate outflow pathways to handle subsurface flows. Subsurface flows can be regulated using underdrains, the volume of storage in the reservoir layer, the bed slope of the reservoir layer, and/or a control structure at the outlet (see Section 3.5.2, “Permeable Pavement Conveyance Criteria”).

#### 3.5.5 Permeable Pavement Landscaping Criteria

Permeable pavement does not have any landscaping needs. However, large-scale permeable pavement applications should be carefully planned to integrate the typical landscaping features of a parking lot, such as trees and islands, in a manner that maximizes runoff treatment and minimizes the risk that sediment, mulch, grass clippings, leaves, and other plant matter will inadvertently clog the paving surface. Bioretention areas (see Section 3.6, “Bioretention”) may be a good design option to meet these landscaping goals.

### **3.5.6 Permeable Pavement Construction Sequence**

Experience has shown that proper installation is critical to the effective operation of a permeable pavement system.

**Soil Erosion and Sediment Controls.** The following soil erosion and sediment control guidelines must be followed during construction:

- All permeable pavement areas must be fully protected from sediment intrusion by silt fence or construction fencing, particularly if they are intended to infiltrate runoff.
- Permeable pavement areas intended to infiltrate runoff must remain outside the limits of disturbance during construction to prevent soil compaction by heavy equipment and loss of design infiltration rate (unless the area has been determined to have a low California Bearing Ratio and will require compaction during the permeable pavement construction phase) (ASTM, 2009). Where it is infeasible to keep the proposed permeable pavement areas outside of the limits of disturbance, there are several possible remedies for the impacted area.
  - ◆ If excavation in the proposed permeable pavement areas can be restricted, then remediation can be achieved with deep tilling practices. This is only possible if in situ soils are not disturbed any deeper than 2 feet above the final design elevation of the bottom of the aggregate reservoir course. In this case, when heavy equipment activity has ceased, the area is excavated to grade, and the impacted area must be tilled to a depth of 12 inches below the bottom of the reservoir layer.
  - ◆ Alternatively, if it is infeasible to keep the proposed permeable pavement areas outside of the limits of disturbance, and excavation of the area cannot be restricted, then infiltration tests will be required prior to installation of the permeable pavement to ensure that the design infiltration rate is still present. If tests reveal the loss of design infiltration rates, then deep tilling practices may be used in an effort to restore those rates. In this case, further testing must be done before the permeable pavement can be installed to establish that design rates have been achieved.
  - ◆ Finally, if it is infeasible to keep the proposed permeable pavement areas outside of the limits of disturbance, excavation of the area cannot be restricted, and infiltration tests reveal design rates cannot be restored, then a resubmission of the SWMP will be required.
- Permeable pavement areas must be clearly marked on all construction documents and grading plans.
- During construction, care should be taken to avoid tracking sediments onto any permeable pavement surface to avoid post-construction clogging and long-term maintenance issues.



- Any area of the site intended ultimately to be a permeable pavement area with an infiltration component should not be used as the site of a temporary sediment trap or basin. If locating a temporary sediment trap or basin on an area intended for permeable pavement is unavoidable, the remedies are similar to those discussed for heavy equipment compaction.
  - ◆ If it is possible, restrict the invert of the sediment trap or basin to at least 1 foot above the final design elevation of the bottom of the aggregate reservoir course of the proposed permeable pavement. Then remediation can be achieved with proper removal of trapped sediments and deep tilling practices.
  - ◆ An alternate approach to deep tilling is to use an impermeable liner to protect the in situ soils from sedimentation while the sediment trap or basin is in use.
  - ◆ In each case, all sediment deposits in the excavated area must be carefully removed prior to installing the sub-base, base, and surface materials. The plan must also show the proper procedures for converting the temporary sediment control practice to a permeable pavement BMP, including dewatering, cleanout, and stabilization.

**Permeable Pavement Installation.** The following is a typical construction sequence to properly install permeable pavement, which may need to be modified depending on the particular type of permeable pavement that is being installed.

**Step 1: Stabilize Contributing Drainage Area.** Construction of the permeable pavement should only begin after the entire CDA has been stabilized. The proposed site should be checked for existing utilities prior to any excavation. Do not install the system in rain or snow and do not install frozen bedding materials.

**Step 2: Install Soil Erosion and Sediment Control Measures for the Permeable Pavement.** As noted above, temporary soil erosion and sediment controls are needed during installation to divert stormwater away from the permeable pavement area until it is completed. Special protection measures, such as erosion control fabrics, may be needed to protect vulnerable side slopes from erosion during the excavation process. The proposed permeable pavement area must be kept free from sediment during the entire construction process. Construction materials contaminated by sediment must be removed and replaced with clean material.

**Step 3: Minimize Impact of Heavy Installation Equipment.** Where possible, excavators or backhoes should work from the sides to excavate the reservoir layer to its appropriate design depth and dimensions. For small pavement applications, excavating equipment should have arms with adequate extension so they do not have to work inside the footprint of the permeable pavement area (to avoid compaction). Contractors can utilize a cell construction approach, whereby the proposed permeable pavement area is split into 500- to 1,000-square foot temporary cells with a 10- to 15-foot-wide earth bridge in between, so cells can be excavated from the side. Excavated material should be placed away from the open excavation so as to not jeopardize the stability of the side walls.

**Step 4: Promote Infiltration Rate.** The native soils along the bottom of the permeable pavement system should be scarified or tilled to a depth of 3 to 4 inches prior to the placement of the filter layer or geotextile fabric. In large-scale paving applications with weak soils, the soil subgrade may need to be compacted to 95% of the Standard Proctor Density to achieve the desired load-bearing capacity.

Note: This may reduce or eliminate the infiltration function of the installation, and it must be addressed during hydrologic design.

**Step 5: Order of Materials.** Geotextile fabric should be installed on the sides of the reservoir layer (and the bottom if the design calls for it). Geotextile fabric strips should overlap down-slope by a minimum of 2 feet and be secured a minimum of 4 feet beyond the edge of the excavation. Where the filter layer extends beyond the edge of the pavement (to convey runoff to the reservoir layer), install an additional layer of geotextile fabric 1 foot below the surface to prevent sediment from entering into the reservoir layer. Excess geotextile fabric should not be trimmed until the site is fully stabilized.

**Step 6: Install Base Material Components.** The up-gradient end of underdrains in the reservoir layer should be capped. Where an underdrain pipe is connected to a structure, there shall be no perforations within 1 foot of the structure. Ensure there are no perforations in clean-outs and observation wells within 1 foot of the surface.

**Step 7: Stone Media.** Spread 6-inch lifts of the appropriate stone aggregate (usually No. 2 or No. 57 stone) washed clean and free of fines. Place at least 4 inches of additional aggregate above the underdrain, and then compact it using a vibratory roller in static mode until there is no visible movement of the aggregate. Do not crush the aggregate with the roller.

**Step 8: Reservoir Media.** Install the desired depth of the bedding layer, depending on the type of pavement, as indicated in Table 3-12.

**Step 9: Paving Media.** Paving materials shall be installed in accordance with manufacturer or industry specifications for the particular type of pavement.

**Installation of Porous Asphalt.** The following has been excerpted from various documents, most notably Jackson (2007):

- Install porous asphalt pavement similarly to regular asphalt pavement. The pavement should be laid in a single lift over the filter course. The laying temperature should be between 230°F and 260°F, with a minimum air temperature of 50°F, to ensure the surface does not stiffen before compaction.
- Complete compaction of the surface course when the surface is cool enough to resist a 10-ton roller. One or two passes of the roller are required for proper compaction. More rolling could cause a reduction in the porosity of the pavement.
- The mixing plant must provide certification of the aggregate mix, abrasion loss factor, and asphalt content in the mix. Test the asphalt mix for its resistance to stripping by water using the standards in ASTM D1664. If the estimated coating area is not above 95%, additional anti-stripping agents must be added to the mix.
- Transport the mix to the site in a clean vehicle with smooth dump beds sprayed with a non-petroleum release agent. The mix shall be covered during transportation to control cooling.
- Test the full permeability of the pavement surface by application of clean water at a rate of at least 5 gallons per minute over the entire surface. All water must infiltrate directly, without puddle formation or surface runoff.

- Inspect the facility 18 to 30 hours after a significant rainfall (0.5 inch or greater) or artificial flooding to determine if the facility is draining properly.

**Pervious Concrete Installation.** The basic installation sequence for pervious concrete is outlined by NRMCA, 2004. It is strongly recommended that concrete installers successfully complete a recognized pervious concrete installers training program, such as the Pervious Concrete Contractor Certification Program offered by the NRMCA. The basic installation procedure is as follows:

- Drive the concrete truck as close to the project site as possible.
- Water the underlying aggregate (reservoir layer) before the concrete is placed, so the aggregate does not draw moisture from the freshly laid pervious concrete.
- After the concrete is placed, approximately 3/8 to 1/2 inch is struck off, using a vibratory screed. This is to allow for compaction of the concrete pavement.
- Compact the pavement with a steel pipe roller. Care should be taken to ensure over-compaction does not occur.
- Cut joints for the concrete to a depth of 1/4 inch.
- The curing process is very important for pervious concrete. Concrete installers should follow manufacturer specifications to the extent allowed by on-site conditions when curing pervious concrete. This typically requires covering the pavement with plastic sheeting within 20 minutes of the strike-off and may require keeping it covered for at least 7 days. Do not allow traffic on the pavement during the curing period.
- Remove the plastic sheeting only after the proper curing time. Inspect the facility 18 to 30 hours after a significant rainfall (0.5 inch or greater) or artificial flooding, to determine if the facility is draining properly.

**Permeable Interlocking Concrete Paver Installation.** The basic installation process is described in greater detail by Smith (2006):

- Place edge restraints for open-jointed pavement blocks before the bedding layer and pavement blocks are installed. Permeable interlocking concrete pavement systems require edge restraints to prevent vehicle loads from moving the paver blocks. Edge restraints may be standard curbs or gutter pans, or precast or cast-in-place reinforced concrete borders a minimum of 6 inches wide and 18 inches deep, constructed with Class A3 concrete. Edge restraints along the traffic side of a permeable pavement block system are recommended.
- Place the No. 57 stone in a single lift. Level the filter course and compact it into the reservoir course beneath with at least four passes of a 10-ton steel drum static roller until there is no visible movement. The first two passes are in vibratory mode, with the final two passes in static mode. The filter aggregate should be moist to facilitate movement into the reservoir course.
- Place and screed the bedding course material (typically No. 8 stone).

- Fill gaps at the edge of the paved areas with cut pavers or edge units. When cut pavers are needed, cut the pavers with a paver splitter or masonry saw. Cut pavers no smaller than 1/3 of the full unit size.
- Pavers may be placed by hand or with mechanical installers. Fill the joints and openings with stone. Joint openings must be filled with ASTM D448 No. 8 stone; although, No. 8P or No. 9 stone may be used where needed to fill narrower joints. Remove excess stones from the paver surface.
- Compact and seat the pavers into the bedding course with a minimum low-amplitude 5,000-pound-foot, 75- to 95-Hz plate compactor.
- Do not compact within 6 feet of the unrestrained edges of the pavers.
- The system must be thoroughly swept by a mechanical sweeper or vacuumed immediately after construction to remove any sediment or excess aggregate.
- Inspect the area for settlement. Any blocks that settle must be reset and re-inspected.
- Inspect the facility 18 to 30 hours after a significant rainfall (0.5 inch or greater) or artificial flooding to determine whether the facility is draining properly.

**Construction Supervision.** Supervision before, during, and after construction by a qualified professional is recommended to ensure permeable pavement is built in accordance with these specifications. ASTM test C1781 or C1701 must be performed to ensure initial pavement permeability of at least 6 inches per hour. Inspection checklists that require sign-offs by qualified individuals should be used at critical stages of construction to ensure the contractor's interpretation of the plan is consistent with the designer's intent.

DOEE's construction phase inspection checklist for permeable pavement practices can be found in Appendix L - Construction Inspection Checklists.

Some common pitfalls can be avoided by careful construction supervision that focuses on the following key aspects of permeable pavement installation:

- Store materials in a protected area to keep them free from mud, dirt, and other foreign materials.
- The CDA should be stabilized prior to directing water to the permeable pavement area.
- Check the aggregate material to confirm it is clean and washed, meets specifications and is installed to the correct depth. Aggregate loads that do not meet the specifications or do not appear to be sufficiently washed may be rejected.
- Check elevations (i.e., the invert of the underdrain, inverts for the inflow, and outflow points) and the surface slope.
- Make sure the permeable pavement surface is even, runoff spreads evenly across it, and the storage bed drains within 48 hours.
- Ensure caps are placed on the upstream (but not the downstream) ends of the underdrains.
- Inspect the pretreatment structures (if applicable) to make sure they are properly installed and working effectively.

- Once the final construction inspection has been completed, log the GPS coordinates for each facility and submit them for entry into the BMP maintenance tracking database.

Runoff diversion structures are recommended to protect larger permeable pavement applications from early runoff-producing storms, particularly when up-gradient conventional asphalt areas drain to the permeable pavement. This can help reduce the input of fine particles often produced shortly after conventional asphalt is laid.

### 3.5.7 Permeable Pavement Maintenance Criteria

Maintenance is a required and crucial element to ensure the long-term performance of permeable pavement. The most frequently cited maintenance problem is surface clogging caused by organic matter and sediment. Periodic street sweeping will remove accumulated sediment and help prevent clogging; however, it is also critical to ensure that surrounding land areas remain stabilized.

The following tasks must be avoided on all permeable pavements:

- Sanding
- Resealing
- Resurfacing
- Power washing
- Storage of snow piles containing sand
- Storage of mulch or soil materials
- Construction staging on unprotected pavement

It is difficult to prescribe the specific types or frequency of maintenance tasks that are needed to maintain the hydrologic function of permeable pavement systems over time. The frequency of maintenance will depend largely on the pavement use, traffic loads, and the surrounding land use.

**One preventative maintenance task for large-scale applications (e.g., parking lots) involves vacuum sweeping on a frequency consistent with the use and loadings encountered in the site. Many experts consider an annual, dry-weather sweeping in the spring months to be important. The contract for sweeping should specify that a vacuum sweeper be used that does not use water spray, since spraying may lead to subsurface clogging. Typical maintenance tasks are outlined in**

Table 3-13.

**Table 3-13 Typical Maintenance Tasks for Permeable Pavement Practices**

Frequency	Maintenance Tasks
After installation	<ul style="list-style-type: none"> <li>▪ For the first 6 months following construction, the practice and CDA should be inspected at least twice after storm events that exceed 0.5 inch of rainfall. Conduct any needed repairs or stabilization.</li> </ul>

Frequency	Maintenance Tasks
Once every 1–2 months during the growing season	<ul style="list-style-type: none"> <li>▪ Mow grass in grid paver applications (clippings should be removed from the pavement area).</li> </ul>
As needed	<ul style="list-style-type: none"> <li>▪ Stabilize the CDA to prevent erosion.</li> <li>▪ Remove any soil or sediment deposited on pavement.</li> <li>▪ Replace or repair any pavement surfaces that are degenerating or spalling.</li> </ul>
2–4 times per year (depending on use)	<ul style="list-style-type: none"> <li>▪ Mechanically sweep pavement with a standard street sweeper to prevent clogging.</li> </ul>
Annually	<ul style="list-style-type: none"> <li>▪ Conduct a maintenance inspection</li> <li>▪ Remove weeds as needed.</li> </ul>
Once every 2–3 years	<ul style="list-style-type: none"> <li>▪ Remove any accumulated sediment in pretreatment cells and inflow points.</li> </ul>
If clogged	<ul style="list-style-type: none"> <li>▪ Conduct maintenance using a regenerative street sweeper or a vacuum sweeper</li> <li>▪ Replace any necessary joint material.</li> </ul>

**Seasonal Maintenance Considerations:** Winter maintenance for permeable pavements is similar to standard pavements, with a few additional considerations:

- Large snow storage piles should be located in adjacent grassy areas so that sediment and pollutants in snowmelt are partially treated before they reach the permeable pavement.
- Sand or cinders should never be applied for winter traction over permeable pavement or areas of standard (impervious) pavement that drain toward permeable pavement, since it will quickly clog the system.
- When plowing plastic reinforced grid pavements, snow plow blades should be lifted 0.5 inch to 1 inch above the pavement surface to prevent damage to the paving blocks or turf. Porous asphalt, pervious concrete, and some permeable pavers can be plowed similarly to traditional pavements, using similar equipment and settings.
- Chloride products should be used judiciously to deice above permeable pavement designed for infiltration, since the salt will be transmitted through the pavement. Salt can be applied but environmentally sensitive deicers are recommended. Permeable pavement applications will generally require less salt application than traditional pavements.

When permeable pavements are installed on private residential lots, homeowners will need to (1) be educated about their routine maintenance needs and (2) understand the long-term maintenance plan.

It is recommended that a qualified professional conduct a spring maintenance inspection and cleanup at each permeable pavement site, particularly at large-scale applications. DOEE’s maintenance inspection checklists for permeable pavements and the Maintenance Service Completion Inspection form can be found in Appendix L - Construction Inspection Checklists.

**Declaration of Covenants.** A declaration of covenants is required that includes all maintenance responsibilities to ensure the continued stormwater performance for the BMP. The declaration of covenants specifies the property owner’s primary maintenance responsibilities, and authorizes DOEE staff to access the property for inspection or corrective action in the event the proper

maintenance is not performed. The declaration of covenants is recorded in the District of Columbia land records. A template form is provided at the end of Chapter 5, “Administration of Stormwater Management Rules” (see Figure 5.11), although variations will exist for situations in which stormwater crosses property lines. The covenant is between the property owner and the Government of the District of Columbia. It is submitted through the Office of the Attorney General. All SWMPs have a maintenance agreement stamp that must be signed for a building permit to be issued. A maintenance schedule must appear on the SWMP. Additionally, a maintenance schedule is required to be included as an exhibit to the declaration of covenants.

Covenants are not required on government properties, but maintenance responsibilities must be either signed by the Responsible Person for Maintenance on a partnership agreement or be identified in a memorandum of understanding that is incorporated into the plan submission.

**Waste Material.** Waste material from the repair, maintenance, or removal of a BMP or land cover shall be removed and disposed of in compliance with applicable federal and District law.

### 3.5.8 Permeable Pavement Stormwater Compliance Calculations

Permeable pavement retention value varies depending on the design configuration of the system.

**Enhanced Designs without Underdrains.** These permeable pavement applications have an infiltration sump, but no underdrain. Enhanced designs receive 100% retention value for the amount of storage volume ( $S_v$ ) provided by the practice (Table 3-14), and are considered an accepted total suspended solids (TSS) treatment practice.

**Table 3-14 Enhanced Permeable Pavement Retention Value and Pollutant Removal**

Retention Value	$= S_v$
Accepted TSS Treatment Practice	Yes

**Enhanced Designs with Underdrains.** These permeable pavement applications have an underdrain and an infiltration sump. Enhanced with Underdrain Designs receive a retention value of 5.0 cubic feet per 100 square feet of practice area and receive 100% retention value for the amount of storage volume provided by the sump ( $S_{v\_sump}$ ). These designs are an accepted TSS removal practice (Table 3-15).

**Table 3-15 Enhanced with Underdrain Pavement Retention Value and Pollutant Removal**

Retention Value	5.0 cubic feet per 100 square feet of practice $+ S_{v\_sump}$
Accepted TSS Treatment Practice	Yes

Note: When using the Stormwater Database, enter an enhanced practice and indicate that the practice is enhanced with an underdrain. Enter the total storage volume (including the infiltration sump and reservoir layer). Then enter the portion of the storage volume that is the infiltration sump.

**Standard Designs.** These permeable pavement applications have an underdrain, but no infiltration sump or water quality filter. Standard designs receive a retention value of 5.0 cubic feet per 100 square feet of practice area and are an accepted TSS removal practice for the amount of storage volume (Sv) provided by the practice (Table 3-16).

**Table 3-16 Standard Permeable Pavement Retention Value and Pollutant Removal**

Retention Value	5.0 cubic feet per 100 square feet of practice
Accepted TSS Treatment Practice	Yes

The practice must be sized using the guidance detailed in Section 3.5.4, “Permeable Pavement Design Criteria.”

Permeable pavement also contributes to peak flow reduction. This contribution can be determined in several ways. One method is to subtract the storage volume (Sv) achieved by the practice from the total runoff volumes for the 2-year, 15-year, and 100-year storms. The resulting reduced runoff volumes can then be used to calculate a reduced NRCS CN for the site or SDA. The reduced NRCS CN can then be used to calculate peak flow rates for the various storm events. Other hydrologic modeling tools that employ different procedures may be used as well.

### 3.5.9 References

American Association of State Highway and Transportation Officials (AASHTO). 1993. AASHTO Guide for Design of Pavement Structures, 4th Edition with 1998 Supplement. Washington, D.C.

American Association of State Highway and Transportation Officials (AASHTO). 2018. M-252, Standard Specification for Corrugated Polyethylene Drainage Pipe. Washington D.C.

American Association of State Highway and Transportation Officials (AASHTO). 2017. M-288, Standard Specification for Geosynthetic Specification for Highway Applications. Washington D.C.

ASTM C1701 / C1701M-17a, Standard Test Method for Infiltration Rate of In Place Pervious Concrete, ASTM International, West Conshohocken, PA, 2017, [www.astm.org](http://www.astm.org)

ASTM C1781 / C1781M-15, Standard Test Method for Surface Infiltration Rate of Permeable Unit Pavement Systems, ASTM International, West Conshohocken, PA, 2015, [www.astm.org](http://www.astm.org)

ASTM D1664-80 (1985), Test Method for Coating and Stripping of Bitumen-Aggregate Mixtures (Withdrawn 1992), ASTM International, West Conshohocken, PA, 1985, [www.astm.org](http://www.astm.org)

ASTM D4429-09a, Standard Test Method for CBR (California Bearing Ratio) of Soils in Place (Withdrawn 2018), ASTM International, West Conshohocken, PA, 2009, [www.astm.org](http://www.astm.org)



- ASTM D448-12 (2017), Standard Classification for Sizes of Aggregate for Road and Bridge Construction, ASTM International, West Conshohocken, PA, 2017, [www.astm.org](http://www.astm.org)
- Brown, R. and W. Hunt. 2009. "Improving Exfiltration from BMPs: Research and Recommendations." North Carolina Cooperative Extension Service Bulletin. Urban Waterways Series.
- District of Columbia Department of Transportation (DDOT) Design and Engineering Manual, 2017. [https://ddot.dc.gov/sites/default/files/dc/sites/ddot/publication/attachments/2017-06-30\\_DDOT\\_DEM.pdf](https://ddot.dc.gov/sites/default/files/dc/sites/ddot/publication/attachments/2017-06-30_DDOT_DEM.pdf)
- District of Columbia Water and Sewer Authority (DC Water) Green Infrastructure Utility Protection Guidelines, 2013. <https://www.dewater.com/sites/default/files/Green%20Infrastructure%20Utility%20Protection%20Guidelines.pdf>
- Hunt, W. and K. Collins. 2008. "Permeable Pavement: Research Update and Design Implications." North Carolina Cooperative Extension Service Bulletin. Urban Waterways Series.
- Jackson, N. 2007. Design, Construction and Maintenance Guide for Porous Asphalt Pavements. National Asphalt Pavement Association (NAPA), Porous Asphalt Pavements for Stormwater Management: Design, Construction, and Maintenance Guide (IS-131). Lanham, MD, 2008. <http://store.asphalt pavement.org/index.php?productID=179>
- National Ready Mixed Concrete Association (NRMCA). 2004. Concrete in Practice – 38: Pervious Concrete. Silver Spring, MD. <http://nrmca.org/aboutconcrete/cips/38p.pdf>
- Smith, D. 2006. Permeable Interlocking Concrete Pavement-selection design, construction and maintenance. Third Edition. Interlocking Concrete Pavement Institute. Herndon, VA.
- Virginia DCR Stormwater Design Specification No. 7: Permeable Pavement Version 1.7. 2010.

### 3.6 Bioretention

**Definition.** Practices that capture and store stormwater runoff and pass it through a filter bed of engineered filter media composed of sand, soil, and organic matter. Filtered runoff may be collected and returned to the conveyance system or allowed to infiltrate into the soil. Design variants include the following:

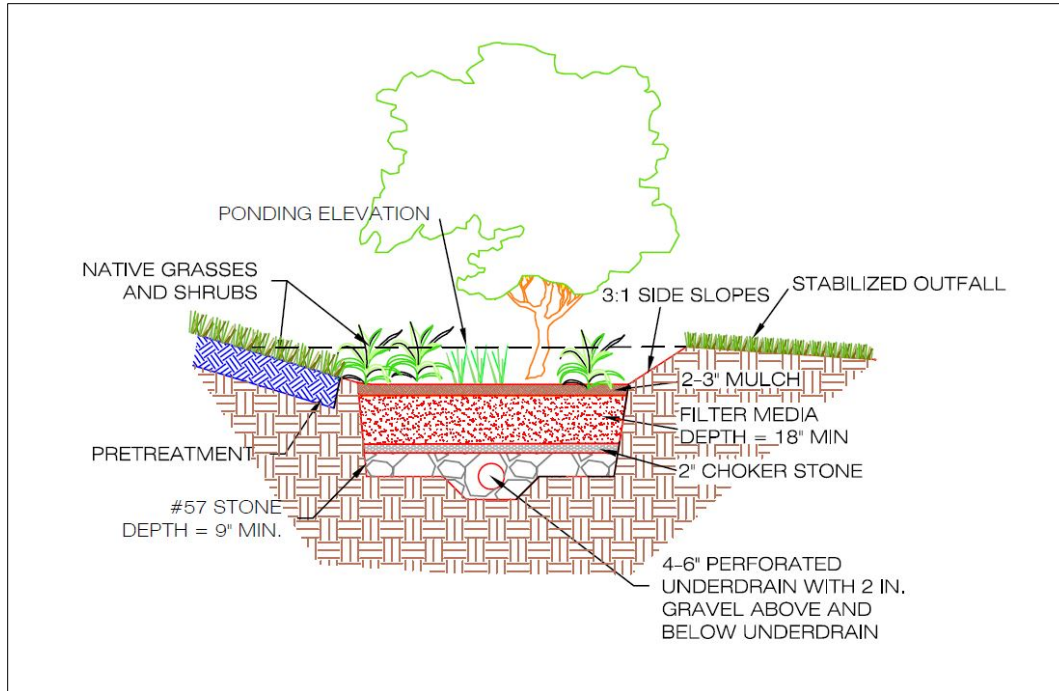
- B-1 Traditional bioretention
- B-2 Streetscape bioretention
- B-3 Engineered tree pits
- B-4 Stormwater planters
- B-5 Residential rain gardens (for single family homes)

Bioretention systems are typically not designed to provide stormwater detention of larger storms (e.g., 2-year, 15-year), but they may be in some circumstances. Bioretention practices shall generally be combined with a separate facility to provide those controls.

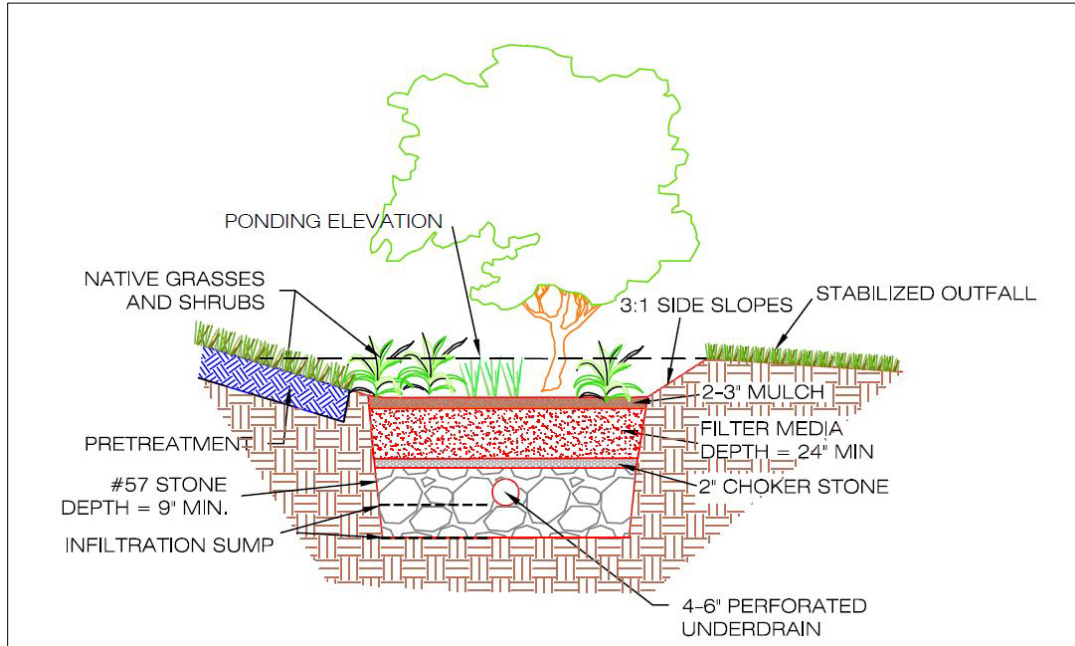
There are two different types of bioretention design configurations:

- **Standard Designs.** Practices with a standard underdrain design and at least 18 inches of filter media depth (see Figure 3.17).
- **Enhanced Designs.** Practices with underdrains that contain at least 24 inches of filter media depth and an infiltration sump/storage layer (see Figure 3.18) or practices that can infiltrate the design storm volume within 72 hours (see Figure 3.19).

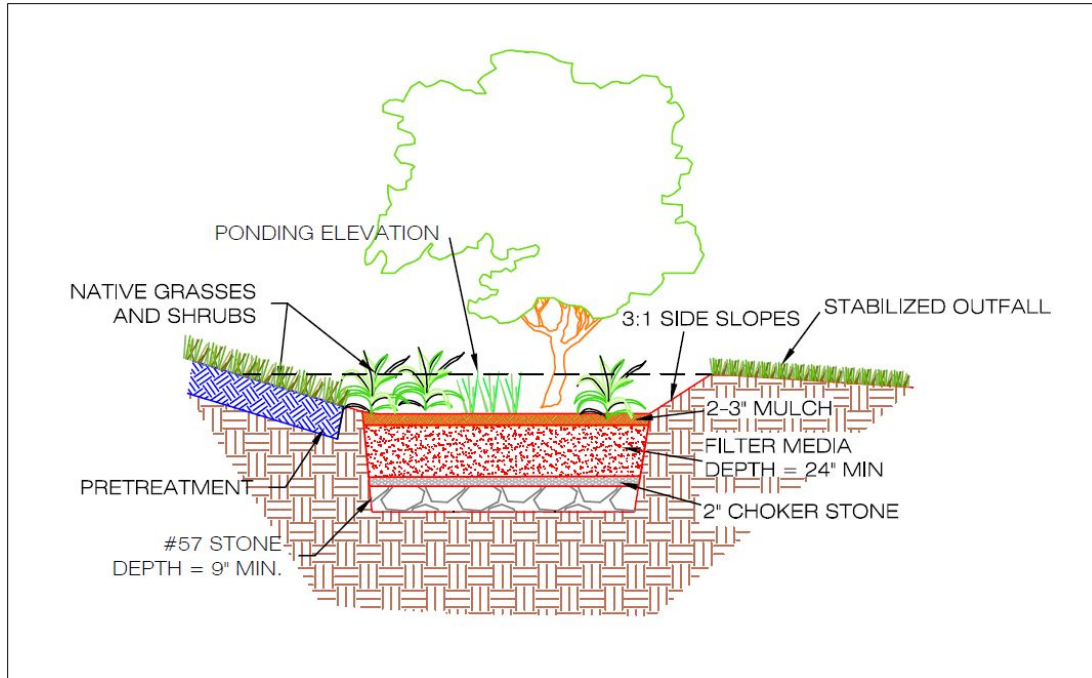
The particular design configuration to be implemented on a site is typically dependent on specific site conditions and the characteristics of the underlying soils. These criteria are further discussed in this chapter.



**Figure 3.17** Example of standard bioretention design.



**Figure 3.18** Example of an enhanced bioretention design with an underdrain and infiltration sump/storage layer.



**Figure 3.19** Example of enhanced bioretention design without an underdrain.

### 3.6.1 Bioretention Feasibility Criteria

Bioretention can be applied in most soils or topography, since runoff simply percolates through an engineered soil bed and is infiltrated or returned to the stormwater system via an underdrain. Key constraints with bioretention include the following:

**Required Space.** Planners and designers can assess the feasibility of using bioretention facilities based on a simple relationship between the CDA and the corresponding bioretention surface area. The surface area is recommended to be approximately 3% to 6% of CDA, depending on the imperviousness of the CDA and the desired bioretention ponding depth.

**Available Hydraulic Head.** Bioretention is fundamentally constrained by the invert elevation of the existing conveyance system to which the practice discharges (i.e., the bottom elevation needed to tie the underdrain from the bioretention area into the storm drain system). In general, 4 to 5 feet of elevation above this invert is needed to accommodate the required ponding and filter media depths. If the practice does not include an underdrain or if an inverted or elevated underdrain design is used, less hydraulic head may be adequate.

**Water Table.** Bioretention must be separated from the water table to ensure that groundwater does not intersect the filter bed. Mixing can lead to possible groundwater contamination or failure of the bioretention facility. A separation distance of 2 feet is required between the bottom of the excavated bioretention area and the seasonally high groundwater table.

**Soils and Underdrains.** Soil conditions do not typically constrain the use of bioretention, although they do determine whether an underdrain is needed. Underdrains may be required if the measured permeability of the underlying soils is less than 0.5 inch per hour. When designing a bioretention practice, designers must verify soil permeability by using the on-site soil investigation methods provided in Appendix P - Geotechnical Information Requirements for Underground BMPs. Impermeable soils will require an underdrain.

For fill soil locations, geotechnical investigations are required to determine if it is necessary to use an impermeable liner and underdrain.

**Contributing Drainage Area.** Bioretention cells work best with smaller CDAs, where it is easier to achieve flow distribution over the filter bed. The maximum CDA to a traditional bioretention area (B-1) is 2.5 acres and can consist of up to 100% impervious cover. The CDA for smaller bioretention practices (B-2, B-3, B-4, and B-5) is a maximum of 1 acre. However, if hydraulic considerations are adequately addressed to manage the potentially large peak inflow of larger CDAs, such as off-line or low-flow diversions, or forebays, there may be case-by-case instances where the maximum CDAs can be adjusted. Table 3-17 summarizes typical recommendations for bioretention CDAs.

**Table 3-17 Maximum Contributing Drainage Area to Bioretention**

Bioretention Type	Design Variants	Maximum Contributing Drainage Area (acres of impervious cover)
Traditional	B-1	2.5
Small-scale bioretention	B-2, B-3, B-4, and B-5	1.0

**Hotspot Land Uses.** An impermeable bottom and side liner and an underdrain system must be employed when a bioretention area will receive untreated hotspot runoff, and the enhanced design configuration cannot be used. However, bioretention can still be used to treat parts of the site that are outside of the hotspot area. For instance, roof runoff can go to bioretention while vehicular maintenance areas would be treated by a more appropriate hotspot practice.

For a list of potential stormwater hotspots, please consult Appendix Q - Stormwater Hotspots.

On sites with existing contaminated soils, infiltration is not allowed. Bioretention areas must be lined on the bottom and all sides in an impermeable liner, and the Enhanced Design configuration cannot be used.

**No Irrigation or Baseflow.** The planned bioretention area should not receive baseflow, irrigation water, chlorinated wash-water or any other flows not related to stormwater. However, irrigation is allowed during the establishment period of the bioretention area to ensure plant survival.

**Setbacks.** To avoid the risk of seepage, stormwater cannot flow from the bioretention reservoir layer to a traditional pavement base layer, existing structure foundations, or an area where there may be future development adjacent to the property line. Setbacks to structures and property

lines must be at least 10 feet, and adequate waterproofing protection must be provided for foundations and basements. Where the 10-foot setback is not possible, an impermeable liner may be used along the sides of the bioretention area extending from the surface to the bottom of the practice.

**Proximity to Utilities.** Designers should ensure that future tree canopy growth in the bioretention area will not interfere with existing overhead utility lines. When large site development is undertaken the expectation of achieving avoidance will be high. Conflicts may be commonplace on smaller sites and in the PROW. Consult with each utility company on recommended offsets, which will allow utility maintenance work with minimal disturbance to the bioretention system. For bioretention in the PROW a consolidated presentation of the various utility offset recommendations can be found in Chapter 28.8.4.4 of the District of Columbia Department of Transportation (DDOT) Design and Engineering Manual. Consult the District of Columbia Water and Sewer Authority (DC Water) Green Infrastructure Utility Protection Guidelines, for water and sewer line recommendations. Where conflicts cannot be avoided, follow these guidelines:

- Consider altering the location or sizing of the bioretention to avoid or minimize the utility conflict. Consider an alternate BMP type to avoid conflict.
- Use design features to mitigate the impacts of conflicts that may arise by allowing the bioretention and the utility to coexist. The bioretention design may need to incorporate impervious areas, through geotextiles or compaction, to protect utility crossings.
- Work with the utility to evaluate the relocation of the existing utility and install the optimum placement and sizing of the bioretention.
- If utility functionality, longevity, and vehicular access to manholes can be assured, accept the bioretention design and location with the existing utility. Incorporate into the bioretention design sufficient soil coverage over the utility or general clearances or other features such as an impermeable liner to assure all entities the conflict is limited to maintenance.

Note: When accepting utility conflict into the bioretention location and design, it is understood the bioretention will be temporarily impacted during utility work but the utility owner will replace the bioretention or, alternatively, install a functionally comparable bioretention according to the specifications in the current version of this guidebook. If the bioretention is located in the PROW, the bioretention restoration will also conform with the District of Columbia Department of Transportation Design and Engineering Manual with special attention to Chapter 28 and the Design and Engineering Manual supplements for “Low Impact Development” and “Green Infrastructure Standards and Specifications.”

**Minimizing External Impacts.** Urban bioretention practices may be subject to higher public visibility, greater trash loads, pedestrian traffic, vandalism, and even vehicular loads. Designers should design these practices in ways that prevent, or at least minimize, such impacts. In addition, designers should clearly recognize the need to perform frequent landscaping maintenance to remove trash, check for clogging, and maintain vigorous vegetation. The urban landscape context may feature naturalized landscaping or a more formal design. When urban bioretention is used in sidewalk areas of high foot traffic, designers should not impede pedestrian

movement or create a safety hazard. Designers may also install low fences, grates, or other measures to prevent damage from pedestrian short-cutting across the practices.

When bioretention will be included in public rights-of-way or spaces, design manuals and guidance developed by agencies or organizations other than DOEE may also apply (e.g., District Department of Transportation, District Office of Planning, and National Capital Planning Commission).

### 3.6.2 Bioretention Conveyance Criteria

There are two basic design approaches for conveying runoff into, through, and around bioretention practices:

1. **Off-line:** Flow is split or diverted so that only the design storm or design flow enters the bioretention area. Larger flows bypass the bioretention treatment.
2. **On-line:** All runoff from the CDA flows into the practice. Flows that exceed the design capacity exit the practice via an overflow structure or weir.

If runoff is delivered by a storm drain pipe or is along the main conveyance system, the bioretention area should be designed off-line so that flows do not overwhelm or damage the practice.

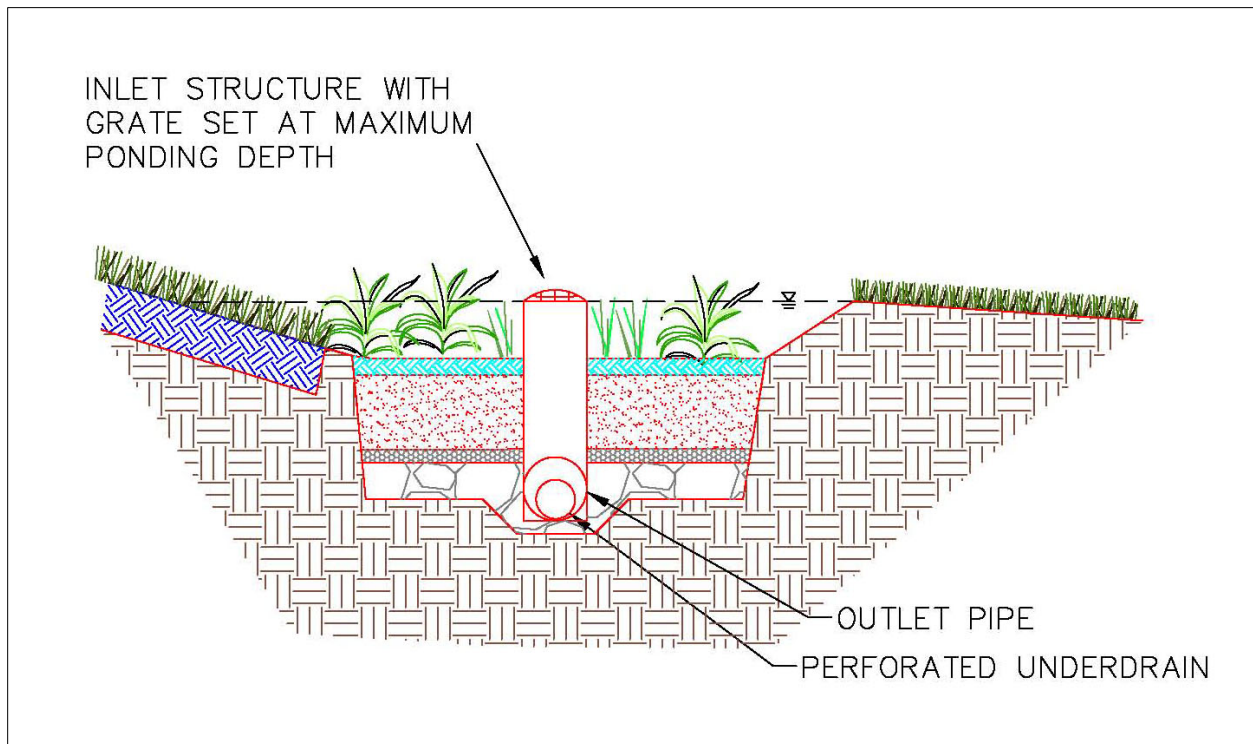
**Off-line Bioretention.** Overflows are diverted from entering the bioretention cell. Optional diversion methods include the following:

- Create an alternate flow path at the inflow point into the structure such that when the maximum ponding depth is reached, the incoming flow is diverted past the facility. In this case, the higher flows do not pass over the filter bed and through the facility, and additional flow is able to enter as the ponding water filters through the filter media. With this design configuration, an overflow structure in the bioretention area is not required.
- Utilize a low-flow diversion or flow splitter at the inlet to allow only the design storm volume (i.e., the SWRV) to enter the facility (calculations must be made to determine the peak flow from the 1.2-inch, 24-hour storm). This may be achieved with a weir, curb opening, or orifice for the target flow, in combination with a bypass channel or pipe. Using a weir or curb opening helps minimize clogging and reduces the maintenance frequency. With this design configuration, an overflow structure in the bioretention area is required (see on-line bioretention below).

**On-line Bioretention.** An overflow structure must be incorporated into on-line designs to safely convey larger storms through the bioretention area (see Figure 3.20). The following criteria apply to overflow structures:

- An overflow shall be provided within the practice to pass storms greater than the design storm storage to a stabilized water course. A portion of larger events may be managed by the bioretention area so long as the maximum depth of ponding in the bioretention cell does not exceed 18 inches.

- The overflow device must convey runoff to a storm sewer, stream, or the existing stormwater conveyance infrastructure, such as curb and gutter or an existing channel.
- Common overflow systems within bioretention practices consist of an inlet structure, where the top of the structure is placed at the maximum ponding depth of the bioretention area, which is typically 6 to 18 inches above the surface of the filter bed.
- The overflow device should be scaled to the application. This may be a landscape grate or yard inlet for small practices or a commercial-type structure for larger installations.
- At least 3 inches of freeboard must be provided between the 15-year design storm peak elevation and the top of the bioretention area to ensure that nuisance flooding will not occur.
- The overflow associated with the 2-year and 15-year design storms must be controlled so that velocities are non-erosive (generally less than 6 feet per second) at the outlet point, to prevent downstream erosion.



**Figure 3.20 Example of an overflow structure in an on-line bioretention area.**

### 3.6.3 Bioretention Pretreatment Criteria

Pretreatment of runoff entering bioretention areas is necessary to trap coarse sediment particles before they reach and prematurely clog the filter bed. Pretreatment measures must be designed to evenly spread runoff across the entire width of the bioretention area. Several pretreatment measures are feasible, depending on the type of the bioretention practice and whether it receives sheet flow, shallow concentrated flow, or deeper concentrated flows. The following are appropriate pretreatment options:



**Small-Scale Bioretention (B-2, B-3, B-4, and B-5)**

- **Leaf Screens.** A leaf screen serves as part of the gutter system to keep the heavy loading of organic debris from accumulating in the bioretention cell.
- **Pretreatment Cells** (for channel flow). Pretreatment cells are located above ground or covered by a manhole or grate. Pretreatment cells are atypical in small-scale bioretention and are not recommended for residential rain gardens (B-5).
- **Grass Filter Strips** (for sheet flow). Grass filter strips are applied on residential lots, where the lawn area can serve as a grass filter strip adjacent to a rain garden.
- **Stone Diaphragm** (for either sheet flow or concentrated flow). The stone diaphragm at the end of a downspout or other concentrated inflow point should run perpendicular to the flow path to promote settling.

Note: stone diaphragms are not recommended for school settings.

- **Trash Racks** (for either sheet flow or concentrated flow). Trash racks are located between the pretreatment cell and the main filter bed or across curb cuts to allow trash to collect in specific locations and make maintenance easier.

**Traditional Bioretention (B-1)**

- **Pretreatment Cells** (for channel flow). Similar to a forebay, this cell is located at piped inlets or curb cuts leading to the bioretention area and consists of an energy dissipator sized for the expected rates of discharge. It has a storage volume equivalent to at least 15% of the total storage volume (inclusive) with a recommended 2:1 length-to-width ratio. The cell may be formed by a wooden or stone check dam or an earthen or rock berm. Pretreatment cells do not need underlying engineered filter media, in contrast to the main bioretention cell. However, if the volume of the pretreatment cell will be included as part of the bioretention storage volume, the pretreatment cell must de-water between storm events. It cannot have a permanent ponded volume.
- **Grass Filter Strips** (for sheet flow). Grass filter strips that are perpendicular to incoming sheet flow extend from the edge of pavement, with a slight drop at the pavement edge, to the bottom of the bioretention basin at a 5H:1V slope or flatter. Alternatively, if the bioretention basin has side slopes that are 3H:1V or flatter, a 5-foot grass filter strip can be used at a maximum 5% (20H:1V) slope.
- **Stone Diaphragms** (for sheet flow). A stone diaphragm located at the edge of the pavement should be oriented perpendicular to the flow path to pretreat lateral runoff, with a 2- to 4-inch drop from the pavement edge to the top of the stone. The stone must be sized according to the expected rate of discharge.
- **Gravel or Stone Flow Spreaders** (for concentrated flow). The gravel flow spreader is located at curb cuts, downspouts, or other concentrated inflow points, and should have a 2- to 4-inch elevation drop from a hard-edged surface into a gravel or stone diaphragm. The gravel

must extend the entire width of the opening and create a level stone weir at the bottom or treatment elevation of the basin.

- **Filter System** (see Section 3.7, “Stormwater Filtering Systems”). If using a filter system as a pretreatment facility, the filter will not require a separate pretreatment facility.
- **Innovative or Proprietary Structure.** An approved proprietary structure with demonstrated capability of reducing sediment and hydrocarbons may be used to provide pretreatment. Refer to Section 3.13, “Proprietary Practices,” for information on approved proprietary structures.

Other pretreatment options may be appropriate as long as they trap coarse sediment particles and evenly spread runoff across the entire width of the bioretention area.

### 3.6.4 Bioretention Design Criteria

**Design Geometry.** Bioretention basins must be designed with an internal flow path geometry such that the treatment mechanisms provided by the bioretention are not bypassed or short-circuited. In order for the bioretention area to have an acceptable internal geometry, the travel time from each inlet to the outlet should be maximized by locating the inlets and outlets as far apart as possible. In addition, incoming flow must be distributed as evenly as possible across the entire filter surface area.

**Inlets and Energy Dissipation.** Where appropriate, the inlet(s) to streetscape bioretention (B-2), engineered tree boxes (B-3), and stormwater planters (B-4) should be stabilized using No. 3 stone, splash block, river stone, or other acceptable energy dissipation measures. The following types of inlets are recommended:

- Downspouts to stone energy dissipators
- Sheet flow over a depressed curb with a 3-inch drop
- Curb cuts allowing runoff into the bioretention area
- Covered drains that convey flows across sidewalks from the curb or downspouts
- Grates or trench drains that capture runoff from a sidewalk or plaza area
- Drop structures that appropriately dissipate water energy

Inlets must be designed with sufficient width and slope to avoid unintended bypass. This is of particular concern for curb cuts on streetscape bioretention designs.

**Ponding Depth.** The recommended surface ponding depth is 6 to 12 inches. Minimum surface ponding depth is 3 inches (averaged over the surface area of the BMP). Ponding depths can be increased to a maximum of 18 inches. However, when higher ponding depths are utilized, the design must consider carefully issues such as safety, fencing requirements, aesthetics, the viability and survival of plants, and erosion and scour of side slopes. This is especially true where bioretention areas are built next to sidewalks or other areas where pedestrians or bicyclists travel. Shallower ponding depths (typically 6 to 12 inches) are recommended for streetscape bioretention (B-2), engineered tree boxes (B-3), and stormwater planters (B-4).

**Side Slopes.** Traditional bioretention areas (B-1) and residential rain gardens (B-5) should be constructed with side slopes of 3H:1V or flatter. In space-constrained areas, a drop curb design or a precast structure can be used to create a stable, vertical side wall. These drop curb designs should not exceed a vertical drop of more than 12 inches, unless safety precautions, such as railings, walls, grates, etc. are included.

**Filter Media.** The filter media of a bioretention practice consists of an engineered soil mixture that has been carefully blended to create a filter media that maintains long-term permeability while also providing enough nutrients to support plant growth. The final filter media shall consist of a well-blended mixture of medium to coarse **sand, loam soil**, and an **organic amendment** (compost). The sand maintains the desired permeability of the media while the limited amount of loam soil and organic amendments are considered adequate to help support initial plant growth. It is anticipated that the gradual increase of organic material through natural processes will continue to support plant growth without the need to add fertilizer, and the root structure of maturing plants and the biological activity of the media will maintain sufficient long-term permeability.

The following is the recommended composition of the three media ingredients:

- **Sand (Fine Aggregate).** Sand should consist of silica-based medium to coarse sand and be angular or round in shape. The materials shall not be derived from serpentine, shall be free of surface coatings or any other deleterious materials, and shall contain less than 0.5% mica by weight when tested with ASTM C295.

ASTM C-33, Standard Specification for Concrete Aggregates, concrete sand will typically meet the requirements for the sand to be used in filter media. However, some samples of ASTM C-33 sand may have too high a fraction of fine sand and silt- and clay-sized particles to meet the final filter media particle size distribution requirements. In general, coarser gradations of ASTM C-33 will better meet the filter media particle size distribution and hydraulic conductivity requirements.

Any other materials, such as manufactured sand, limestone-based sands, or crushed glass, shall meet the required particle size distribution of the final filter media mixture and be adequately durable when tested by AASHTO T-103, Soundness of Aggregates by Freezing and Thawing, or T-104, Standard Method of Test for Soundness of Aggregate by Use of Sodium Sulfate or Magnesium Sulfate.

- **Loam Soil.** Loam soil is generally defined as the combination of sand-sized material, fines (silt and clay), and any associated soil organic matter. Since the objective of the specification is to carefully establish the proper blend of these ingredients in the final filter media, the designer (or contractor or materials supplier) must carefully select the topsoil source material in order to not exceed the amount of any one ingredient.

Generally, a natural loamy sand, sandy loam, or loam (per the United States Department of Agriculture (USDA) Textural Triangle, [https://www.nrcs.usda.gov/wps/portal/nrcs/detail/soils/survey/?cid=nrcs142p2\\_054167](https://www.nrcs.usda.gov/wps/portal/nrcs/detail/soils/survey/?cid=nrcs142p2_054167)) A-horizon topsoil free of subsoil, large stones, earth clods, sticks, stumps, clay lumps, roots, viable noxious weed seed, plant propagules, brush, or other objectionable, extraneous matter or debris is suitable for the loam soil source material.

- **Organic Amendments.** Organic amendments shall consist of stable, well-composted, natural, carbon-containing organic materials such as leaf mulch, peat moss, humus, or yard waste (consistent with the material specifications found in Appendix K - Soil Compost Amendment Requirements). The material shall be free of debris such as plastics, metal, concrete, stones larger than 1/2 inch, larger branches and roots, and wood chips over 1 inch in length or diameter.

**Complete Filter Media.** The complete filter media shall consist of a pug milled or mechanically blended mix of the three source materials. Mixing the filter media on-site with excavation or loading equipment is not sufficient. The resulting filter media must meet the following particle size composition:

- 80%–90% sand
- 10%–20% silt and clay
- Maximum 10% clay

The particle size analysis must be conducted on the mineral fraction only or following appropriate treatments to remove organic matter before particle size analysis.

Note: The above percentages are based on weight rather than volume. The DDOT Green Infrastructure Standards include a bioretention soil specification based on volume, not weight, so the percentages listed there do not match those listed here, even though the two specifications are substantially equivalent.

Additionally, the final filter media mix must meet the grain size distribution indicated in Table 3-18 or have a saturated hydraulic conductivity of 2 to 6 inches per hour according to test procedure ASTM D2434 when compacted (at 60% to 80% optimum moisture content) to a minimum of 86% of the maximum density as determined by AASHTO T 99, Standard Method of Test for Moisture–Density Relations of Soils Using a 2.5-kg (5.5-lb) Rammer and a 305-mm (12-in.) Drop.

**Table 3-18 Filter Media Grain Size Distribution**

Sieve Type	Particle Size (mm)	Percent Passing (%)
	8.0	100
No. 5	4.0	92–100
No. 10	2.0	72–100
No. 18	1.0	43–95
No. 35	0.5	20–65
No. 60	0.25	11–37
No. 140	0.105	10–25
No. 270	0.053	10–20
	0.002	0–10

The filter media shall also meet the following criteria (see summary in Table 3-19):

- Organic content shall be between 3.0% and 5.0% by weight;

- pH shall be between 6.0 and 7.5;
- Cation exchange capacity (CEC) shall be a minimum of 5 milliequivalents (meq)/100 grams (g) or centimole of charge (cmol+)/kilogram (kg);
- Phosphorus content shall meet one of the following:
  - ◆ P-Index between 10 and 30;
  - ◆ 5 to 15 mg/kg Mehlich I Extraction;
  - ◆ 18 to 40 mg/kg Mehlich III Extraction; and
- Soluble salts shall be less than 500 parts per million (ppm) or less than 0.5 millimhos (mmhos)/centimeter (cm).

Notes:

1. P-Index is an agronomic test used in North Carolina to indicate the potential for P leaching from soil. The test method has been revised to add P concentration to facilitate local lab testing. The value of the P-Index is the correlation between the CEC and P concentrations: higher CEC indicates greater adsorption sites within the media, thus increasing the ability to fix P within the soil, thereby allowing higher P concentrations without leaching. While P-Index may be a better overall representation of P, the test method may not be readily available.
2. Tests for organic content, CEC, soluble salts, and pH are referenced to be in accordance with Northeastern Regional Publication No. 493. Use the following tests:
  - (a) Test for soil content by loss of weight on ignition
  - (b) Test for soil CEC by exchangeable acidity method
  - (c) Test for soluble salts shall be by the 1:2 (V:V) Soil:Water Extract Method
  - (d) Test for pH by the SMP method

**Table 3-19 Summary of Filter Media Criteria for Bioretention**

Filter Media Criterion	Description	Standard(s)
General Composition	Filter media must have the proper proportions of sand, loam soil, and organic amendments to promote plant growth, drain at the proper rate, and filter pollutants.	80%–90% sand; 10%–20% soil fines; maximum of 10% clay; and 3%–5% organic content  Must meet final filter media grain size distribution OR have a saturated hydraulic conductivity of 2–6 inches per hour
Sand	Medium to coarse aggregate	Based on final filter media grain size distribution
Loam Soil	Loamy sand, sandy loam, or loam	USDA Textural Triangle
Organic Amendments	Stable, well-composted, natural, carbon-containing organic materials such as leaf mulch, peat moss, humus, or yard waste.	Appendix K
P-Index or Phosphorus (P) Content	Filter media with high P levels will export P through the media and potentially to downstream conveyances or receiving waters.	P-Index of 10–30 or P content = 5–15 mg/kg (Mehlich I) or 18–40 mg/kg (Mehlich III)
Cation Exchange Capacity (CEC)	The CEC is determined by the amount of soil fines and organic matter. Higher CEC will promote pollutant removal.	CEC > 5 milliequivalents per 100 grams
pH	Soil pH influences nutrient availability and microbial populations.	Between 6.0 and 7.5
Soluble Salts	Filter media with high levels of soluble salts can injure or kill plants.	Less than 500 ppm or less than 0.5 mmhos/cm.

In cases where greater removal of specific pollutants is desired, additives with documented pollutant removal benefits, such as water treatment residuals, alum, iron, or other materials, may be included in the filter media if accepted by DOEE.

**Filter Media Depth.** The filter media bed depth must be a minimum of 18 inches for the Standard Design, not including the mulch layer. The media depth must be 24 inches or greater to qualify for the Enhanced Design, unless an infiltration-based design is used. The media depth must not exceed 6.5 feet. Turf, perennials, or shrubs should be used instead of trees to landscape shallower filter beds. See

Table 3-22 and Table 3-23 for a list of recommended native plants.

During high intensity storm events, it is possible for the bioretention to fill up faster than the collected stormwater is able to filter through the filter media. This is dependent upon the surface

area of the BMP (SA) relative to the CDA and the runoff coefficient ( $R_v$ ) from the CDA. To ensure that the design runoff volume is captured and filtered appropriately, a maximum filter media depth must not be exceeded (see Table 3-20). The maximum filter media depth is based on the runoff coefficient of the CDA to the BMP ( $R_{vCDA}$ ) and the bioretention ratio of BMP surface area to the BMP CDA (SA:CDA) (in percent). The  $R_{vCDA}$  is an average of runoff coefficients of land cover types in the BMP's CDA. The land cover runoff coefficient types can be selected from Table H.1 Runoff Coefficient Factors for Typical District of Columbia Land Uses, or using the three categories established for calculating the SWR $v$  (natural, compacted, and impervious cover). The applicable filter media depth from Table 3.20 should be used as  $d_{media}$  in Equation 3.5. Note: In the gray cells, overflow is not likely to occur for the design storm, so no maximum filter media depth is specified.

**Table 3-20 Determining Maximum Filter Media Depth (feet)**

SA:CDA (%)	$R_{vCDA}$								
	0.25	0.3	0.40	0.50	0.60	0.70	0.80	0.90	0.95
0.5	6.5	6.5	6.5	6.5	6.5	6.5	6.5	6.5	6.5
1.0	5.0	5.5	6.0	6.5	6.5	6.5	6.5	6.5	6.5
1.5	3.5	4.0	5.0	6.0	6.0	6.5	6.5	6.5	6.50
2.0		3.0	4.0	4.5	5.5	6.0	6.0	6.5	6.5
2.5			3.5	4.0	4.5	5.0	5.5	6.0	6.0
3.0				3.5	4.0	4.5	5.0	5.5	5.5
3.5					3.5	4.0	4.5	5.0	5.0
4.0					3.0	3.5	4.0	4.5	4.5
4.5						3.5	3.5	4.0	4.0
5.0							3.5	4.0	4.0
5.5								3.5	3.5
6.0								3.0	3.5
6.5									3.0
7.0+									

**Surface Cover.** Mulch is the recommended surface cover material, but other materials may be substituted, as described below:

- **Mulch.** A 2- to 3-inch layer of mulch on the surface of the filter bed enhances plant survival, suppresses weed growth, pretreats runoff before it reaches the filter media, and prevents rapid evaporation of rainwater. Shredded hardwood bark mulch, aged for at least 6 months, makes a very good surface cover, as it retains a significant amount of pollutants and typically will not float away. The maximum depth of the mulch layer is 3 inches.
- **Alternative to Mulch Cover.** In some situations, designers may consider alternative surface covers, such as turf, native groundcover, erosion control matting (e.g., coir or jute matting), river stone, or pea gravel. The decision regarding the type of surface cover to use should be based on function, expected pedestrian traffic, cost, and maintenance. When alternative surface covers are used, methods to discourage pedestrian traffic should be considered. Stone

or gravel are not recommended in parking lot applications, since they increase soil temperature and have low water-holding capacity.

- **Media for Turf Cover.** One adaptation suggested for use with turf cover is to design the filter media primarily as a sand filter with organic content only at the top. Compost, as specified in Appendix K - Soil Compost Amendment Requirements, tilled into the top layers will provide organic content for the vegetative cover. If grass is the only vegetation, the ratio of organic matter in the filter media composition may be reduced.

**Choking Layer.** A 2- to 4-inch layer of choker stone (e.g., typically ASTM D448 No. 8 or No. 89 gravel washed clean and free of fines) should be placed beneath the filter media and over the underdrain stone.

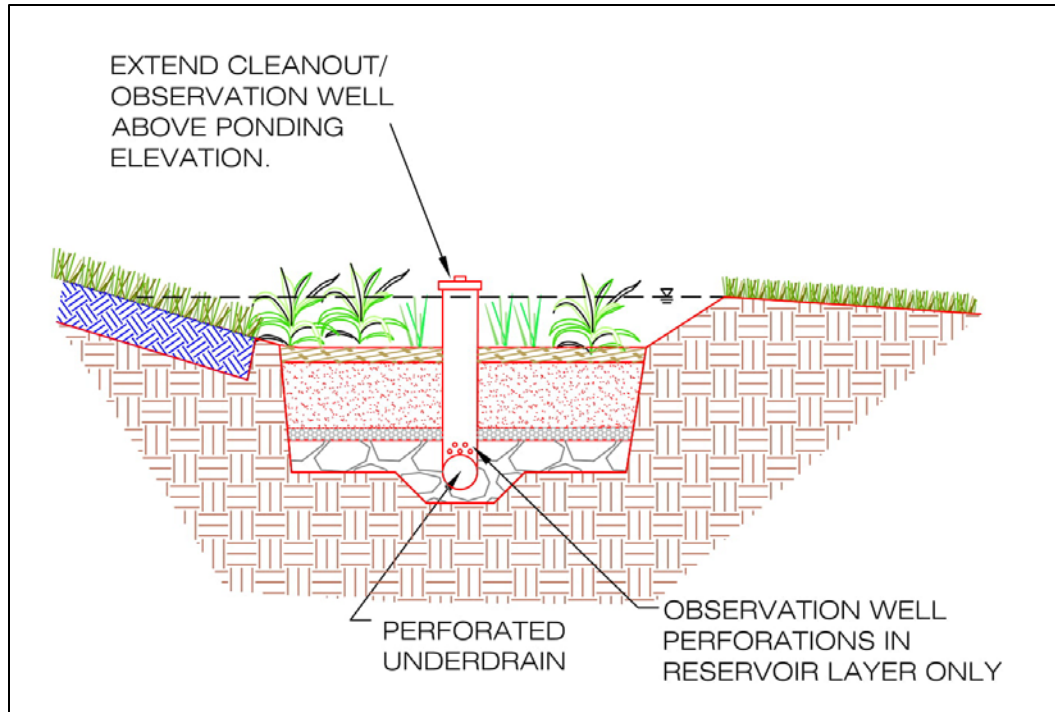
**Geotextile.** If the available head is limited, or the depth of the practice is a concern, geotextile fabric may be used in place of the choking layer. An appropriate geotextile fabric that complies with AASHTO M-288 Class 2 (latest edition available here: <https://store.transportation.org/item/publicationdetail/3791>) requirements, and has a permeability of at least an order of magnitude (10 times) higher than the soil subgrade permeability must be used. Geotextile fabric may be used on the sides of bioretention areas as well.

**Underdrains.** Many bioretention designs will require an underdrain (see Section 3.6.1 Bioretention Feasibility Criteria). The underdrain should be a 4- or 6-inch perforated schedule 40 PVC pipe, or equivalent corrugated HDPE for small bioretention BMPs, with three or four rows of 3/8-inch perforations at 6 inches on center. The underdrain must be encased in a layer of ASTM D448 No.57 or smaller (No. 68, 8, or 89) stone that is washed clean and free of fines. The maximum depth of the underdrain stone layer combined with the choking layer is 12 inches, and it cannot extend beyond the surface dimensions of the bioretention filter media. The underdrain must be sized so that the bioretention BMP fully drains within 72 hours or less. See Appendix H Design of Flow Control Structures for the circular orifice equation.

Multiple underdrains may be necessary for bioretention areas wider than 40 feet, and each underdrain is recommended to be located no more than 20 feet from the next pipe or the edge of the bioretention. For long and narrow applications, a single underdrain running the length of the bioretention is sufficient. Each underdrain must include a cleanout pipe (minimum 4 inches in diameter).

**Observation Wells.** All bioretention practices must include at least one observation well consisting of a well-anchored, 4- to 6-inch diameter PVC pipe (see Figure 3.21). For standard bioretention practices, the non-perforated observation wells should be tied into any of the T or Y connections in the underdrain system and must extend upward above the ponding level. These observation wells can also double as cleanouts. Enhanced bioretention practices should be perforated in the gravel layer only and also must extend upward to the top of ponding.





**Figure 3.21 Observation well/cleanout device.**

**Underground Storage Layer (optional).** For bioretention systems with an underdrain, an underground storage layer consisting of chambers, perforated pipe, stone, or other acceptable material can be incorporated below the filter media layer and underdrain to increase the infiltration sump volume or the storage for larger storm events. Unlike the underdrain stone layer, this storage layer can be extended beyond the surface dimensions of the bioretention filter media if additional storage volume is needed. To qualify for the enhanced design, this underground storage layer must be designed to infiltrate within 72 hours. The underground storage layer may also be designed to provide detention for the 2-year, 15-year, or 100-year storms, as needed. The depth and volume of the storage layer will then depend on the target storage volumes needed to meet the applicable detention criteria. Suitable conveyance must also be provided to ensure that the storage is fully utilized without overflow of the bioretention area.

**Impermeable Liner.** An impermeable liner is not typically required, although it may be utilized in fill applications where deemed necessary by a geotechnical investigation, on sites with contaminated soils, or on the sides of the practice to protect adjacent structures from seepage. Use a PVC geomembrane liner or equivalent material of an appropriate thickness (follow manufacturer's instructions for installation). Field seams must be sealed according to the liner manufacturer's specifications. A minimum 6-inch overlap of material is required at all seams.

**Material Specifications.** Recommended material specifications for bioretention areas are shown in Table 3-21.

**Table 3-21 Bioretention Material Specifications**

Material	Specification	Notes
Filter Media	<ul style="list-style-type: none"> <li>See Table 3-18 and Table 3-19</li> </ul>	Minimum depth of 24 inches (18 inches for standard design). To account for settling/compaction, it is recommended that 110% of the plan volume be utilized.
Mulch Layer	Use aged, shredded hardwood bark mulch	Lay a 2- to 3-inch layer on the surface of the filter bed.
Alternative Surface Cover	Use river stone or pea gravel, coir and jute matting, or turf cover.	Lay a 2- to 3-inch layer of to suppress weed growth.
Top Soil for Turf Cover	Loamy sand or sandy loam texture, with less than 5% clay content, pH corrected to between 6 and 7, and an organic matter content of at least 2%.	3-inch tilled into surface layer.
Geotextile or Choking Layer	An appropriate geotextile fabric that complies with AASHTO M-288 Class 2 (latest edition available here: <a href="https://store.transportation.org/item/publicationdetail/3791">https://store.transportation.org/item/publicationdetail/3791</a> ) requirements and has a permeability of at least an order of magnitude (10 times) higher than the soil subgrade permeability must be used	Can use in place of the choking layer where the depth of the practice is limited. Geotextile fabric may be used on the sides of bioretention areas as well.
	Lay a 2- to 4-inch layer of choker stone (e.g., typically No.8 or No.89 washed gravel) over the underdrain stone.	
Underdrain Stone	1-inch diameter stone must be washed clean and free of fines ( with no more than 2% passing the No. 200 sieve) (e.g., ASTM D448 No. 57 or smaller stone).	At least 2 inches above and below the underdrain.
Storage Layer (optional)	To increase storage for larger storm events, chambers, perforated pipe, stone, or other acceptable material can be incorporated below the filter media layer.	
Impermeable Liner (optional)	Where appropriate, use a PVC Geomembrane liner or equivalent material of an appropriate thickness.	
Underdrains, Cleanouts, and Observation Wells	Use 4- or 6-inch rigid schedule 40 PVC pipe, or equivalent corrugated HDPE for small bioretention BMPs, with three or four rows of 3/8-inch perforations at 6 inches on center. Multiple underdrains may be necessary for bioretention areas wider than 40 feet, and each underdrain is recommended to be located no more than 20 feet from the next pipe or the edge of the bioretention.	Lay the perforated pipe under the length of the bioretention cell, and install non-perforated pipe as needed to connect with the storm drain system or to daylight in a stabilized conveyance. Install T's and Y's as needed, depending on the underdrain configuration. Extend cleanout pipes to the surface of ponding.
Plant Materials	See Section 3.6.5 Bioretention Landscaping Criteria	Establish plant materials as specified in the landscaping plan and the recommended plant list.

**Signage.** Bioretention units in highly urbanized areas should be stenciled or otherwise permanently marked to designate it as a structural BMP. The stencil or plaque should indicate (1) its water quality purpose, (2) that it may pond briefly after a storm, and (3) that it is not to be disturbed except for required maintenance.

**Specific Design Issues for Streetscape Bioretention (B-2).** Streetscape bioretention is installed in the road right-of-way either in the sidewalk area or in the road itself. In many cases, streetscape bioretention areas can also serve as traffic-calming or street-parking control devices. The basic design adaptation is to move the raised concrete curb closer to the street or in the street, and then create inlets or curb cuts that divert street runoff into depressed vegetated areas within the right-of-way. Roadway stability can be a design issue where streetscape bioretention practices are installed. Designers should consult design standards pertaining to roadway drainage. It may be necessary to provide an impermeable liner on the road side of the bioretention area to keep water from saturating the road's sub-base. Streetscape bioretention in the PROW should comply with Section 33.14.5.1 of the DDOT Green Infrastructure Standards.

**Specific Design Issues for Engineered Tree Boxes (B-3).** Engineered tree boxes are installed in the sidewalk zone near the street where urban street trees are normally installed (see Figure 3.22). The soil volume for the tree pit is increased and used to capture and treat stormwater. Treatment is increased by using a series of connected tree planting areas together in a row. The surface of the enlarged planting area may be mulch, grates, permeable pavers, or conventional pavement. The large and shared rooting space and a reliable water supply increase the growth and survival rates in this otherwise harsh planting environment. Engineered tree boxes in the PROW should comply with Section 33.14.5.1 of the DDOT Green Infrastructure Standards.

When designing engineered tree boxes, the following criteria may apply:

- Engineered tree box designs sometimes cover portions of the filter media with pervious pavers or cantilevered sidewalks (see Figure 3.23). In these situations, the following design considerations must be incorporated:
  - ◆ The filter media must be connected beneath the surface so that stormwater and tree roots can share this space.
  - ◆ As with all bioretention areas, a minimum surface ponding depth of 3 inches, averaged over the surface area of the bioretention area, is required. For example, if the additional surface area under the pavement doubles the overall surface area, then the ponding depth will need to be at least 6 inches.
  - ◆ Sand based structural soil (SBSS) (as defined in Section 621.09 of the DDOT Green Infrastructure Standards) may be considered as bioretention filter media if it meets the same phosphorus content limits. However, if the SBSS is to be compacted beyond the DDOT Green Infrastructure Standards maximum compaction for bioretention, it shall be assigned a porosity of 0.10. The DDOT Green Infrastructure Standards call for bioretention soil to be compacted to 84% maximum dry density while SBSS is to be compacted to 93%.
- Installing an engineered tree pit grate over filter bed media is one possible solution to prevent pedestrian traffic and trash accumulation.
- Low, wrought iron fences can help restrict pedestrian traffic across the tree pit bed and serve as a protective barrier if there is a drop-off from the pavement to the micro-bioretention cell.
- A removable grate may be used to allow the tree to grow through it.

- Each tree needs a minimum rootable soil volume as described in Section 3.14, “Tree Planting and Preservation.”.
- See Section 3.14.2 Planting Trees and Figure 3.45 for further guidance and requirements on tree planting.

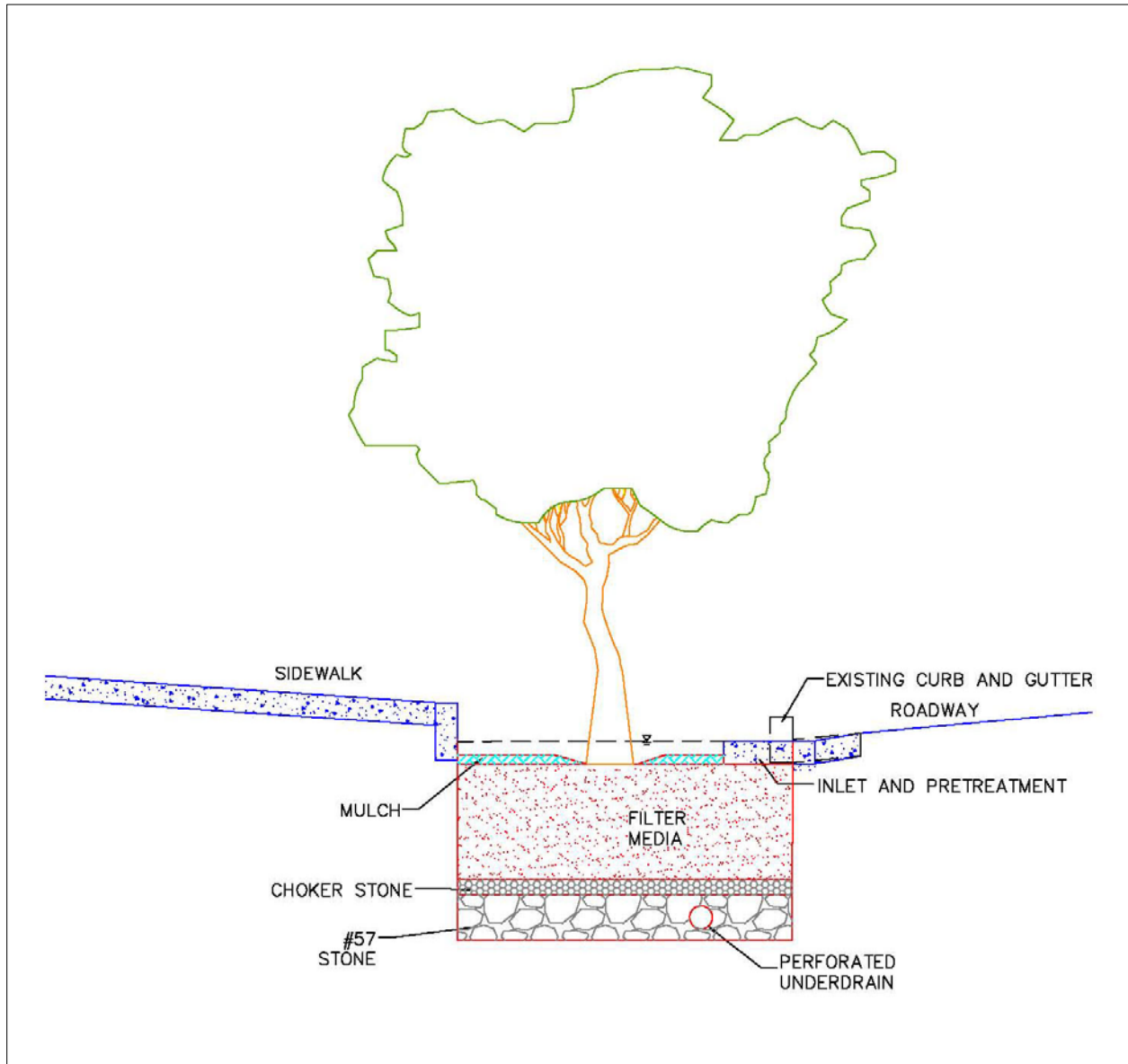
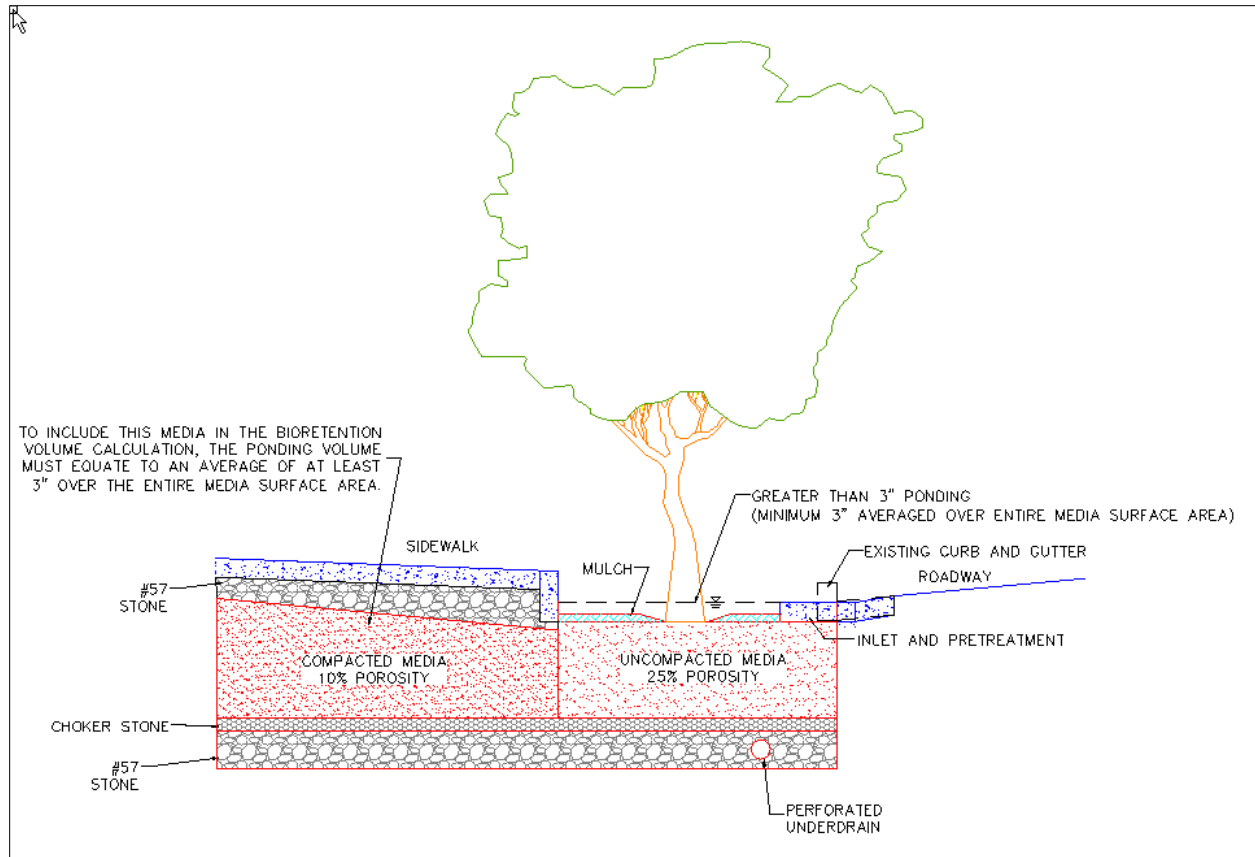


Figure 3.22 Example of tree box cross section.



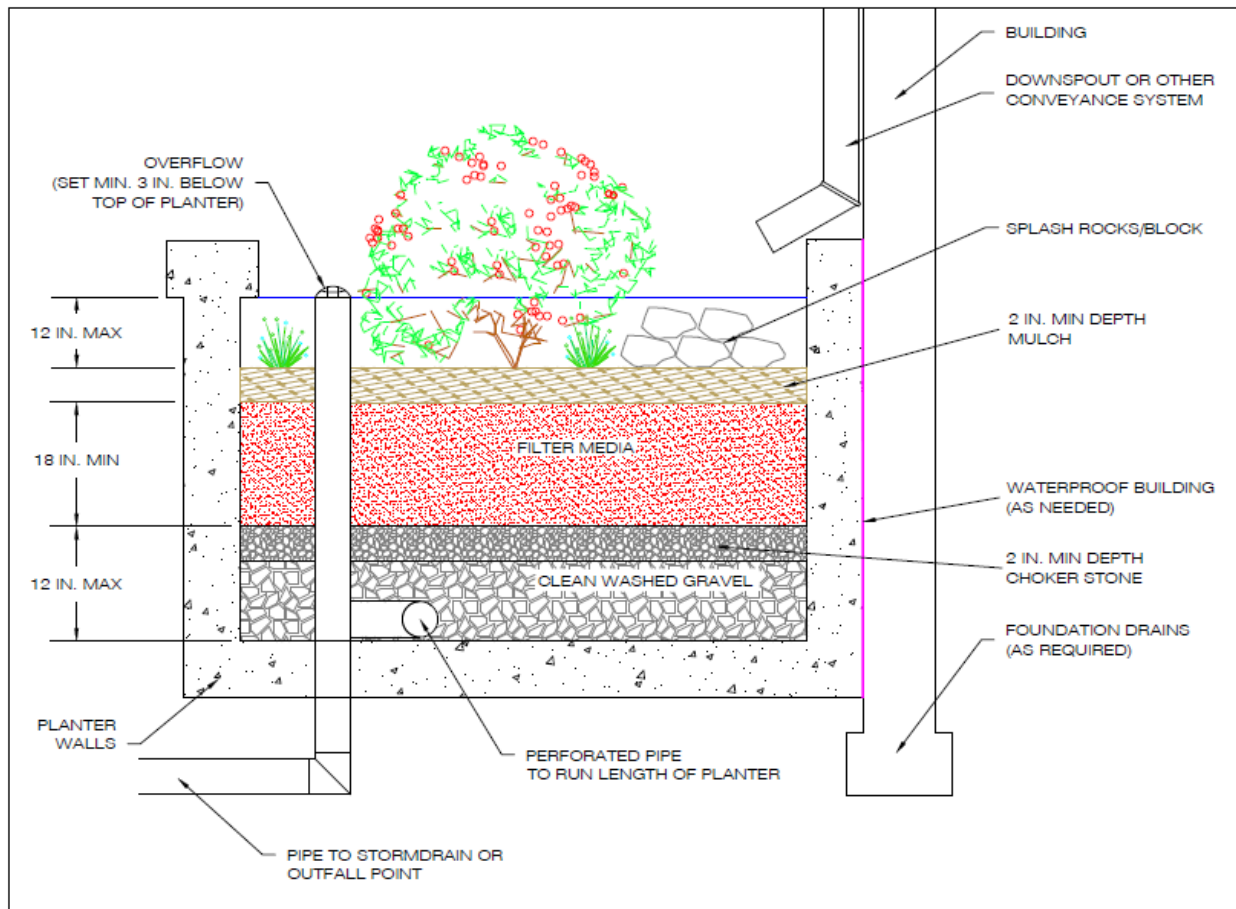
**Figure 3.23 Example of tree box cross section with compacted media extending below sidewalk.**

**Specific Design Issues for Stormwater Planters (B-4).** Stormwater planters are a useful option to disconnect and treat rooftop runoff, particularly in ultra-urban areas. They consist of confined planters that store and/or infiltrate runoff in a soil bed to reduce runoff volumes and pollutant loads. Stormwater planters combine an aesthetic landscaping feature with a functional form of stormwater treatment. Stormwater planters generally receive runoff from adjacent rooftop downspouts and are landscaped with plants that tolerate periods of both drought and inundation. The two basic design variations for stormwater planters are the infiltration planter and the filter planter. A filter planter is illustrated in Figure 3.24.

An infiltration planter filters rooftop runoff through soil in the planter followed by infiltration into soils below the planter. The minimum filter media depth is 18 inches, with the shape and length determined by architectural considerations. Infiltration planters should be placed at least 10 feet away from a building to prevent possible flooding or basement seepage damage.

A filter planter does not allow for infiltration and is constructed with a watertight concrete shell or an impermeable liner on the bottom to prevent seepage. Since a filter planter is self-contained and does not infiltrate into the ground, it can be installed right next to a building. The minimum filter media depth is 18 inches, with the shape and length determined by architectural considerations. Runoff is captured and temporarily ponded above the planter bed. Overflow pipes are installed to discharge runoff when maximum ponding depths are exceeded, to avoid

water spilling over the side of the planter. In addition, an underdrain is used to carry runoff to the storm sewer system.



**Figure 3.24 Example of a stormwater planter (B-4).**

All planters should be placed at grade level or above ground. Plant materials must be capable of withstanding moist and seasonally dry conditions. The planter can be constructed of stone, concrete, brick, wood, or other durable material. If treated wood is used, care should be taken so that trace metals and creosote do not leach out of the planter.

**Specific Design Issues for Residential Rain Gardens (B-5).** For some residential applications, front, side, and/or rear yard bioretention may be an attractive option. This form of bioretention captures roof, lawn, and driveway runoff from low- to medium- density residential lots in a depressed area (i.e., 6 to 12 inches) between the home and the primary stormwater conveyance system (i.e., roadside ditch or pipe system). The bioretention area connects to the drainage system with an underdrain.

The bioretention filter media must be at least 18 inches deep. The underdrain is directly connected into the storm drain pipe running underneath the street or in the street right-of-way. A

trench needs to be excavated during construction to connect the underdrain to the street storm drain system.

Construction of the remainder of the bioretention system is deferred until after the lot has been stabilized. Residential rain gardens require regular maintenance to perform effectively.

**BMP Sizing.** Bioretention is typically sized to capture the SWR<sub>v</sub> or larger design storm volumes in the surface ponding area, filter media, and gravel reservoir layers of the BMP.

Total storage volume of the BMP is calculated using Equation 3.5.

### Equation 3.5 Bioretention Storage Volume

$$S_v = SA_{bottom} \times [(d_{media} \times \eta_{media}) + (d_{gravel} \times \eta_{gravel})] + (SA_{average} \times d_{ponding})$$

where:

$S_v$	=	total storage volume of bioretention (ft <sup>3</sup> )
$SA_{bottom}$	=	bottom surface area of bioretention (ft <sup>2</sup> )
$d_{media}$	=	depth of the filter media, including mulch layer (ft)
$\eta_{media}$	=	effective porosity of the filter media (typically 0.25)
$d_{gravel}$	=	depth of the underdrain and underground storage gravel layer, including choker stone (ft)
$\eta_{gravel}$	=	effective porosity of the gravel layer (typically 0.4)
$SA_{average}$	=	average surface area of bioretention (ft <sup>2</sup> ) typically, where $SA_{top}$ is the top surface area of bioretention, $SA_{average} = \frac{SA_{bottom} + SA_{top}}{2}$
$d_{ponding}$	=	maximum ponding depth of bioretention (ft)

Equation 3.5 can be modified if the storage depths of the filter media, gravel layer, or ponded water vary in the actual design or with the addition of any surface or subsurface storage components (e.g., additional area of surface ponding, subsurface storage chambers, etc.). The maximum depth of ponding in the bioretention must not exceed 18 inches. If storage practices will be provided off-line or in series with the bioretention area, the storage practices should be sized using the guidance in Section 3.12, “Storage Practices.”

For enhanced bioretention areas, the volume that will be infiltrated (the sump volume for underdrained designs or the entire volume for non-underdrained designs) must infiltrate within 72 hours. The saturated hydraulic conductivity for the native soils must exceed 0.1 feet per day to qualify for the enhanced design retention value. The depth of the infiltration sump for underdrained designs can be determined using Equation 3.6.

**Equation 3.6 Enhanced Bioretention Infiltration Sump Depth**

$$d_{sump} = \frac{(K_{sat} \times t_d)}{\eta_r}$$

where:

$d_{sump}$	=	depth of the infiltration sump (ft.)
$K_{sat}$	=	field-verified saturated hydraulic conductivity for the native soils (ft/day) (must exceed 0.1 ft/day)
$t_d$	=	drawdown time (3 days)
$\eta_r$	=	available porosity of the stone reservoir (assume 0.4)

For non-underdrained designs, a check must be performed to ensure that the entire  $S_v$  infiltrates within 72 hours, as in Equation 3.7.

**Equation 3.7 Bioretention Infiltration Rate Check**

$$Sv_{infiltrate} = SA_{bottom}(K_{sat} \times t_d)$$

where:

$Sv_{infiltrate}$	=	storage volume that will infiltrate within 72 hours (ft <sup>3</sup> )
$SA_{bottom}$	=	bottom surface area of bioretention (ft <sup>2</sup> )
$K_{sat}$	=	field-verified saturated hydraulic conductivity for the native soils (ft/day)
$t_d$	=	drawdown time (3 days)

If  $Sv_{infiltrate}$  is greater than or equal to  $S_v$ , then the entire  $S_v$  will infiltrate within 72 hours. If it is not, the storage volume of the bioretention area should be reduced accordingly.

Bioretention can be designed to address, in whole or in part, the detention storage needed to comply with channel protection and/or flood control requirements. The  $S_v$  can be counted as part of the 2-year or 15-year runoff volumes to satisfy stormwater quantity control requirements.

Note: In order to increase the storage volume of a bioretention area, the ponding surface area may be increased beyond the filter media surface area. However, the top surface area of the practice (i.e., at the top of the ponding elevation) may not be more than twice the size of the surface area of the filter media ( $SA_{bottom}$ ).

**3.6.5 Bioretention Landscaping Criteria**

Landscaping is critical to the performance and function of bioretention areas. Therefore, a landscaping plan shall be provided for bioretention areas.

Minimum plan elements include the proposed bioretention template to be used, delineation of planting areas, and the planting plan including the following:



- Common and botanical names of the plants used
- Size of planted materials
- Mature size of the plants
- Light requirements
- Maintenance requirements
- Source of planting stock
- Any other specifications
- Planting sequence

It is recommended that the planting plan for bioretention areas be prepared by a landscape architect or other professional with experience with bioretentions. The planting plan must be submitted with the SWMP.

Native plant species are preferred over non-native species, but some ornamental species may be used for landscaping effect if they are not aggressive or invasive. Some popular native species that work well in bioretention areas and are commercially available can be found in

Table 3-22 and Table 3-23. Internet links to more detailed bioretention plant lists developed in the Chesapeake Bay region are provided below:

- Prince Georges County, MD, [http://www.aacounty.org/departments/public-works/highways/forms-and-publications/RG\\_Bioretention\\_PG%20CO.pdf](http://www.aacounty.org/departments/public-works/highways/forms-and-publications/RG_Bioretention_PG%20CO.pdf)
- Delaware Green Technology Standards and Specifications, [http://www.dnrec.state.de.us/DNREC2000/Divisions/Soil/Stormwater/New/GT\\_Std%20&%20Specs\\_06-05.pdf](http://www.dnrec.state.de.us/DNREC2000/Divisions/Soil/Stormwater/New/GT_Std%20&%20Specs_06-05.pdf)

The degree of landscape maintenance that can be provided will determine some of the planting choices for urban bioretention areas. Plant selection differs if the area will be frequently mowed, pruned, and weeded, in contrast to a site that will receive minimum annual maintenance. In areas where less maintenance will be provided and where trash accumulation in shrubbery or herbaceous plants is a concern, consider a “turf and trees” landscaping model where the turf is mowed along with other turf areas on the site. Spaces for herbaceous flowering plants can be included.

**Table 3-22 Herbaceous Plants Appropriate for Bioretention Areas in the District**

Plant	Light	Wetland Indicator <sup>1</sup>	Plant Form	Inundation Tolerance	Notes
Aster, New York ( <i>Aster novi-belgii</i> )	Full Sun– Part Shade	FACW+	Perennial	Yes	Attractive flowers; tolerates poor soils
Aster, New England ( <i>Aster novae-angliae</i> )	Full Sun– Part Shade	FACW	Perennial	Yes	Attractive flowers

Plant	Light	Wetland Indicator <sup>1</sup>	Plant Form	Inundation Tolerance	Notes
Aster, Perennial Saltmarsh ( <i>Aster tenuifolius</i> )	Full Sun–Part Shade	OBL	Perennial	Yes	Salt tolerant
Coreopsis, Threadleaf ( <i>Coreopsis verticillata</i> )	Full Sun–Part Shade	FAC	Perennial	No	Drought tolerant
Beardtongue ( <i>Penstemon digitalis</i> )	Full Sun	FAC	Perennial	No	Tolerates poor drainage
Beebalm ( <i>Monarda didyma</i> )	Full Sun–Part Shade	FAC+	Perennial	Saturated	Herbal uses; attractive flower
Black-Eyed Susan ( <i>Rudbeckia hirta</i> )	Full Sun–Part Shade	FACU	Perennial	No	Common; Maryland state flower
Bluebells, Virginia ( <i>Mertensia virginica</i> )	Part Shade–Full Shade	FACW	Perennial	Yes	Attractive flower; dormant in summer
Blueflag, Virginia ( <i>Iris virginica</i> )	Full Sun–Part Shade	OBL	Perennial	Yes	Tolerates standing water
Bluestem, Big ( <i>Andropogon gerardii</i> )	Full Sun	FAC	Grass	No	Attractive in winter; forms clumps
Bluestem, Little ( <i>Schizachyrium scoparium</i> )	Full Sun	FACU	Grass	No	Tolerates poor soil conditions
Broom-Sedge ( <i>Andropogon virginicus</i> )	Full Sun	FACU	Grass	No	Drought tolerant; attractive fall color
Cardinal Flower ( <i>Lobelia cardinalis</i> )	Full Sun–Part Shade	FACW+	Perennial	Yes	Long bloom time
Fern, New York ( <i>Thelypteris noveboracensis</i> )	Part Shade–Full Shade	FAC	Fern	Saturated	Drought tolerant; spreads
Fern, Royal ( <i>Osmunda regalis</i> )	Full Sun–Full Shade	OBL	Fern	Saturated	Tolerates short term flooding; drought tolerant
Fescue, Red ( <i>Festuca rubra</i> )	Full Sun–Full Shade	FACU	Ground-cover	No	Moderate growth; good for erosion control
Iris, Blue Water ( <i>Iris versicolor</i> )	Full Sun–Part Shade	OBL	Perennial	0-6 inches	Spreads
Lobelia, Great Blue ( <i>Lobelia siphilitica</i> )	Part Shade–Full Shade	FACW+	Perennial	Yes	Blooms in late summer; bright blue flowers
Phlox, Meadow ( <i>Phlox maculata</i> )	Full Sun	FACW	Perennial	Yes	Aromatic; spreads
Sea-Oats ( <i>Uniola paniculata</i> )	Full Sun	FACU-	Grass	No	Salt tolerant; attractive seed heads
Swamp Milkweed ( <i>Asclepias incarnata</i> )	Full Sun–Part Shade	OBL	Perennial	Saturated	Drought tolerant
Switchgrass ( <i>Panicum virgatum</i> )	Full Sun	FAC	Grass	Seasonal	Adaptable; great erosion control
Turtlehead, White ( <i>Chelone glabra</i> )	Full Sun–Part Shade	OBL	Perennial	Yes	Excellent growth; herbal uses
Violet, Common Blue ( <i>Viola papilionacea</i> )	Full Sun–Full Shade	FAC	Perennial	No	Stemless; spreads

Plant	Light	Wetland Indicator <sup>1</sup>	Plant Form	Inundation Tolerance	Notes
Virginia Wild Rye ( <i>Elymus virginicus</i> )	Part Shade–Full Shade	FACW-	Grass	Yes	Adaptable

<sup>1</sup>Notes:

FAC = Facultative, equally likely to occur in wetlands or non-wetlands (estimated probability 34%–66%).

FACU = Facultative Upland, usually occurs in non-wetlands (estimated probability 67%–99%), but occasionally found on wetlands (estimated probability 1%–33%).

FACW = FACW Facultative Wetland, usually occurs in wetlands (estimated probability 67%–99%), but occasionally found in non-wetlands.

OBL = Obligate Wetland, occurs almost always (estimated probability 99%) under natural conditions in wetlands.

Sources: Prince George’s County Maryland Bioretention Manual; Virginia DCR Stormwater Design Specification No. 9: Bioretention.

**Table 3-23 Woody Plants Appropriate for Bioretention Areas in the District**

Plant	Light	Wetland Indicator <sup>1</sup>	Plant Form	Inundation Tolerance	Notes
Arrow-wood ( <i>Viburnum dentatum</i> )	Full Sun–Part Shade	FAC	Shrub	Seasonal	Salt tolerant
River Birch ( <i>Betula nigra</i> )	Full Sun–Part Shade	FACW	Tree	Seasonal	Attractive bark
Bayberry, Northern ( <i>Myrica pennsylvanica</i> )	Full Sun–Part Shade	FAC	Shrub	Seasonal	Salt tolerant
Black Gum ( <i>Nyssa sylvatica</i> )	Full Sun–Part Shade	FACW+	Tree	Seasonal	Excellent fall color
Dwarf Azalea ( <i>Rhododendron atlanticum</i> )	Part Shade	FAC	Shrub	Yes	Long lived
Black-Haw ( <i>Viburnum prunifolium</i> )	Part Shade–Full Shade	FACU+	Shrub	Yes	Edible Fruit
Choke Cherry ( <i>Prunus virginiana</i> )	Full Sun	FACU+	Shrub	Yes	Tolerates some salt; can be maintained as hedge
Cedar, Eastern Red ( <i>Juniperus virginiana</i> )	Full Sun	FACU	Tree	No	Pollution tolerant
Cotton-wood, Eastern ( <i>Populus deltoides</i> )	Full Sun	FAC	Tree	Seasonal	Pollutant tolerant; salt tolerant
Silky Dogwood ( <i>Cornus amomum</i> )	Full Sun–Part Shade	FACW	Shrub	Seasonal	High wildlife value
Hackberry, Common ( <i>Celtis occidentalis</i> )	Full Sun–Full Shade	FACU	Tree	Seasonal	Pollution tolerant
Hazelnut, American ( <i>Corylus americana</i> )	Part Shade	FACU	Shrub	No	Forms thickets; edible nut
Holly, Winterberry ( <i>Ilex laevigata</i> )	Full Sun–Part Shade	OBL	Shrub	Yes	Winter food source for birds
Holly, American ( <i>Ilex opaca</i> )	Full Sun–Full Shade	FACU	Shrub-Tree	Limited	Pollution tolerant

Plant	Light	Wetland Indicator <sup>1</sup>	Plant Form	Inundation Tolerance	Notes
Maple, Red ( <i>Acer rubrum</i> )	Full Sun– Part Shade	FAC	Tree	Seasonal	Very adaptable; early spring flowers
Ninebark, Eastern ( <i>Physocarpus opulifolius</i> )	Full Sun– Part Shade	FACW-	Shrub	Yes	Drought tolerant; attractive bark
Oak, Pin ( <i>Quercus palustris</i> )	Full Sun	FACW	Tree	Yes	Pollution tolerant
Pepperbush, Sweet ( <i>Clethra alnifolia</i> )	Part Shade– Full Shade	FAC+	Shrub	Seasonal	Salt tolerant
Winterberry, Common ( <i>Ilex verticillata</i> )	Full Sun– Full Shade	FACW+	Shrub	Seasonal	Winter food source for birds
Witch-Hazel, American ( <i>Hamamelia virginiana</i> )	Part Shade–Full Shade	FAC-	Shrub	No	Pollution tolerant

<sup>1</sup>Notes:

FAC = Facultative, equally likely to occur in wetlands or non-wetlands (estimated probability 34%–66%).

FACU = Facultative Upland, usually occurs in non-wetlands (estimated probability 67%–99%), but occasionally found on wetlands (estimated probability 1%–33%).

FACW = FACW Facultative Wetland, usually occurs in wetlands (estimated probability 67%–99%), but occasionally found in non-wetlands.

OBL = Obligate Wetland, occurs almost always (estimated probability 99%) under natural conditions in wetlands.

Sources: Prince George’s County Maryland Bioretention Manual; Virginia DCR Stormwater Design Specification No. 9: Bioretention

Planting recommendations for bioretention facilities are as follows:

- The primary objective of the planting plan is to cover as much of the surface areas of the filter bed as quickly as possible. Herbaceous or ground cover layers are as or more important than more widely spaced trees and shrubs.
- Native plant species should be specified over non-native species.
- Plants should be selected based on a specified zone of hydric tolerance and must be capable of surviving both wet and dry conditions (“Wet footed” species should be planted near the center, whereas upland species do better planted near the edge).
- Woody vegetation should not be located at points of inflow; trees should not be planted directly above underdrains but should be located closer to the perimeter.
- Shrubs and herbaceous vegetation should generally be planted in clusters and at higher densities (i.e., 5 feet on-center and 1 to 1.5 feet on-center, respectively).
- If trees are part of the planting plan, a tree density of approximately one tree per 250 square feet (i.e., 15 feet on-center) is recommended.
- Designers should also remember that planting holes for trees must be at least 3 feet deep to provide enough soil volume for the root structure of mature trees. This applies even if the remaining filter media layer is shallower than 3 feet.

- Tree species should be those that are known to survive well in the compacted soils and the polluted air and water of an urban landscape.
- If trees are used, plant shade-tolerant ground covers within the drip line.
- If the bioretention area is to be used for snow storage or is to accept snowmelt runoff, it should be planted with salt-tolerant, herbaceous perennials.

### 3.6.6 Bioretention Construction Sequence

**Soil Erosion and Sediment Controls.** The following soil erosion and sediment control guidelines must be followed during construction:

- All bioretention areas must be fully protected by silt fence or construction fencing.
- Bioretention areas intended to infiltrate runoff must remain outside the limits of disturbance during construction to prevent soil compaction by heavy equipment and loss of design infiltration rate.
  - ◆ Where it is infeasible keep the proposed bioretention areas outside of the limits of disturbance, there are several possible remedies for the impacted area. If excavation in the proposed bioretention area can be restricted, then the remediation can be achieved with deep tilling practices. This is only possible if in situ soils are not disturbed any deeper than 2 feet above the final design elevation of the bottom of the bioretention. In this case, when heavy equipment activity has ceased, the area is excavated to grade, and the impacted area must be tilled to a depth of 12 inches below the bottom of the bioretention.
  - ◆ Alternatively, if it is infeasible to keep the proposed bioretention areas outside of the limits of disturbance, and excavation of the area cannot be restricted, then infiltration tests will be required prior to installation of the bioretention to ensure that the design infiltration rate is still present. If tests reveal the loss of design infiltration rates, then deep tilling practices may be used in an effort to restore those rates. In this case further testing must be done to establish design rates exist before the bioretention area can be installed.
  - ◆ Finally, if it is infeasible to keep the proposed bioretention areas outside of the limits of disturbance, excavation of the area cannot be restricted, and infiltration tests reveal design rates cannot be restored, then a resubmission of the SWMP will be required.
- Bioretention areas must be clearly marked on all construction documents and grading plans.
- Large bioretention applications may be used as small sediment traps or basins during construction. However, these must be accompanied by notes and graphic details on the soil erosion and sediment control plan specifying that (1) the maximum excavation depth of the trap or basin at the construction stage must be at least 1 foot higher than the post-construction (final) invert (bottom of the facility), and (2) the facility must contain an underdrain. The plan must also show the proper procedures for converting the temporary sediment control practice to a permanent bioretention BMP, including dewatering, cleanout, and stabilization.

**Bioretention Installation.** The following is a typical construction sequence to properly install a bioretention basin. These steps may be modified to reflect different bioretention applications or expected site conditions:

**Step 1: Stabilize Contributing Drainage Area.** Construction of the bioretention area may only begin after the entire CDA has been stabilized with vegetation. It may be necessary to block certain curb or other inlets while the bioretention area is being constructed. The proposed site should be checked for existing utilities prior to any excavation.

**Step 2: Preconstruction Meeting.** The designer, the installer, and DOEE inspector must have a preconstruction meeting, checking the boundaries of the CDA and the actual inlet elevations to ensure they conform to original design. Since other contractors may be responsible for constructing portions of the site, it is quite common to find subtle differences in site grading, drainage and paving elevations that can produce hydraulically important differences for the proposed bioretention area. The designer should clearly communicate, in writing, any project changes determined during the preconstruction meeting to the installer and the inspector. Material certifications for aggregate, filter media, and any geotextiles must be submitted for approval to the inspector at the preconstruction meeting.

**Step 3: Install Soil Erosion and Sediment Control Measures to Protect the Bioretention.** Temporary soil erosion and sediment controls (e.g., diversion dikes, reinforced silt fences) are needed during construction of the bioretention area to divert stormwater away from the bioretention area until it is completed. Special protection measures, such as erosion control fabrics, may be needed to protect vulnerable side slopes from erosion during the construction process.

**Step 4: Install Pretreatment Cells.** Any pretreatment cells should be excavated first and then sealed to trap sediment.

**Step 5: Avoid Impact of Heavy Installation Equipment.** Excavators or backhoes should work from the sides to excavate the bioretention area to its appropriate design depth and dimensions. Excavating equipment should have scoops with adequate reach so they do not have to sit inside the footprint of the bioretention area. Contractors should use a cell construction approach in larger bioretention basins, whereby the basin is split into 500- to 1,000-square foot temporary cells with a 10- to 15-foot earth bridge in between, so that cells can be excavated from the side.

**Step 6: Promote Infiltration Rate.** It may be necessary to rip the bottom soils to a depth of 6 to 12 inches to promote greater infiltration.

**Step 7: Order of Materials.** If using a geotextile fabric, place the fabric on the sides of the bioretention area with a 6-inch overlap on the sides. If a stone storage layer will be used, place the appropriate depth of No. 57 stone (washed clean and free of fines) on the bottom, install the perforated underdrain pipe, pack No. 57 stone at least 2 inches above the underdrain pipe, and add the choking layer or appropriate geotextile layer as a filter between the underdrain and the filter media layer. If no stone storage layer is used, start with at least 2 inches of No. 57 stone on the bottom and proceed with the layering as described above.

**Step 8: Layered Installation of Media.** Apply the media in 12-inch lifts until the desired top elevation of the bioretention area is achieved. Wait a few days to check for settlement and add additional media, as needed, to achieve the design elevation.

Note: The batch receipt confirming the source of the filter media must be submitted to the DOEE inspector.

**Step 9: Prepare Filter Media for Plants.** Prepare planting holes for any trees and shrubs, install the vegetation, and water accordingly. Install any temporary irrigation.

**Step 10: Planting.** Install the plant materials as shown in the landscaping plan, and water them as needed.

**Step 11: Secure Surface Area.** Place the surface cover (i.e., mulch, river stone, or turf) in both cells, depending on the design. If coir or jute matting will be used in lieu of mulch, the matting will need to be installed prior to planting (Step 10), and holes or slits will have to be cut in the matting to install the plants.

**Step 12: Inflows.** If curb cuts or inlets are blocked during bioretention installation, unblock these after the CDA and side slopes have good vegetative cover. It is recommended that unblocking curb cuts and inlets take place after two to three storm events if the CDA includes newly installed asphalt, since new asphalt tends to produce a lot of fines and grit during the first several storms.

**Step 13: Final Inspection.** Conduct the final construction inspection using a qualified professional, providing DOEE with an as-built, then log the GPS coordinates for each bioretention facility, and submit them for entry into the maintenance tracking database.

**Construction Supervision.** Supervision during construction is recommended to ensure that the bioretention area is built in accordance with the approved design and this specification. Qualified individuals should use detailed inspection checklists that include sign-offs at critical stages of construction, to ensure that the contractor's interpretation of the plan is consistent with the designer's intentions.

DOEE's construction phase inspection checklist can be found in Appendix L - Construction Inspection Checklists.

### 3.6.7 Bioretention Maintenance Criteria

When bioretention practices are installed, it is the owner's responsibility to ensure they, or those managing the practice, (1) be educated about their routine maintenance needs, (2) understand the long-term maintenance plan, and (3) be subject to a maintenance covenant or agreement, as described below.

Maintenance of bioretention areas should be integrated into routine landscape maintenance tasks. If landscaping contractors will be expected to perform maintenance, their contracts should contain specifics on unique bioretention landscaping needs, such as maintaining elevation differences needed for ponding, proper mulching, sediment and trash removal, and limited use of fertilizers and pesticides.

Maintenance tasks and frequency will vary depending on the size and location of the bioretention, the landscaping template chosen, and the type of surface cover in the practice. A generalized summary of common maintenance tasks and their frequency is provided in Table 3-24.

**Table 3-24 Typical Maintenance Tasks for Bioretention Practices**

Frequency	Maintenance Tasks
Upon establishment	<ul style="list-style-type: none"> <li>▪ For the first 6 months following construction, the practice and CDA should be inspected at least twice after storm events that exceed 0.5 inch of rainfall. Conduct any needed repairs or stabilization.</li> <li>▪ Inspectors should look for bare or eroding areas in the CDA or around the bioretention area and make sure they are immediately stabilized with grass cover.</li> <li>▪ One-time, spot fertilization may be needed for initial plantings.</li> <li>▪ Watering is needed once a week during the first 2 months, and then as needed during first growing season (April through October), depending on rainfall.</li> <li>▪ Remove and replace dead plants. Up to 10% of the plant stock may die off in the first year, so construction contracts should include a care and replacement warranty to ensure that vegetation is properly established and survives during the first growing season following construction.</li> </ul>
At least 4 times per year	<ul style="list-style-type: none"> <li>▪ Mow grass filter strips and bioretention with turf cover</li> <li>▪ Check curb cuts and inlets for accumulated grit, leaves, and debris that may block inflow</li> </ul>
Twice during growing season	<ul style="list-style-type: none"> <li>▪ Spot weed, remove trash, and rake the mulch</li> </ul>
Annually	<ul style="list-style-type: none"> <li>▪ Conduct a maintenance inspection</li> <li>▪ Supplement mulch in devoid areas to maintain a 3-inch layer</li> <li>▪ Prune trees and shrubs</li> <li>▪ Remove sediment in pretreatment cells and inflow points</li> </ul>
Once every 2–3 years	<ul style="list-style-type: none"> <li>▪ Remove sediment in pretreatment cells and inflow points</li> <li>▪ Remove and replace the mulch layer</li> </ul>
As needed	<ul style="list-style-type: none"> <li>▪ Add reinforcement planting to maintain desired vegetation density</li> <li>▪ Remove invasive plants using recommended control methods</li> <li>▪ Remove any dead or diseased plants</li> <li>▪ Stabilize the CDA to prevent erosion</li> </ul>

Standing water is the most common problem outside of routine maintenance. If water remains on the surface for more than 72 hours after a storm, adjustments to the grading may be needed or underdrain repairs may be needed. The surface of the filter bed should also be checked for accumulated sediment or a fine crust that builds up after the first several storm events. There are several methods that can be used to rehabilitate the filter. These are listed below, starting with the simplest approach and ranging to more involved procedures (i.e., if the simpler actions do not solve the problem):

- Open the underdrain observation well or cleanout and pour in water to verify that the underdrains are functioning and not clogged or otherwise in need of repair. The purpose of this check is to see if there is standing water all the way down through the soil. If there is standing water on top, but not in the underdrain, then there is a clogged soil layer. If the underdrain and stand pipe indicates standing water, then the underdrain must be clogged and will need to be cleaned out.
- Remove accumulated sediment and till 2 to 3 inches of sand into the upper 6 to 12 inches of soil.



- Install sand wicks from 3 inches below the surface to the underdrain layer. This reduces the average concentration of fines in the media bed and promotes quicker drawdown times. Sand wicks can be installed by excavating or auguring (i.e., using a tree auger or similar tool) down to the top of the underdrain layer to create vertical columns that are then filled with a clean open-graded coarse sand material (e.g., ASTM C-33, Standard Specification for Concrete Aggregates, concrete sand or similar approved sand mix for bioretention media). A sufficient number of wick drains of sufficient dimension should be installed to meet the design dewatering time for the facility.
- Remove and replace some or all of the filter media.

**Maintenance Inspections.** It is recommended that a qualified professional conduct a spring maintenance inspection and cleanup at each bioretention area. Maintenance inspections should include information about the inlets, the actual bioretention facility (sediment buildup, outlet conditions, etc.), and the state of vegetation (water stressed, dead, etc.) and are intended to highlight any issues that need or may need attention to maintain stormwater management functionality.

DOEE’s maintenance inspection checklists for bioretention areas and the Maintenance Service Completion Inspection form can be found in Appendix M - Maintenance Inspection Checklists

**Declaration of Covenants.** A declaration of covenants is required that includes all maintenance responsibilities to ensure the continued stormwater performance for the BMP. The declaration of covenants specifies the property owner’s primary maintenance responsibilities, and authorizes DOEE staff to access the property for inspection or corrective action in the event the proper maintenance is not performed. The declaration of covenants is recorded in the District of Columbia land records. A template form is provided at the end of Chapter 5, “Administration of Stormwater Management Rules” (see Figure 5.11), although variations will exist for situations in which stormwater crosses property lines. The covenant is between the property owner and the Government of the District of Columbia. It is submitted through the Office of the Attorney General. All SWMPs have a maintenance agreement stamp that must be signed for a building permit to be issued. A maintenance schedule must appear on the SWMP. Additionally, a maintenance schedule is required to be included as an exhibit to the declaration of covenants.

Covenants are not required on government properties, but maintenance responsibilities must be either signed by the Responsible Person for Maintenance on a partnership agreement or be identified in a memorandum of understanding that is incorporated into the plan submission.

**Waste Material.** Waste material from the repair, maintenance, or removal of a BMP or land cover shall be removed and disposed of in compliance with applicable federal and District law.

### 3.6.8 Bioretention Stormwater Compliance Calculations

Bioretention performance varies depending on the design configuration of the system.

**Enhanced Designs.** These designs are bioretention applications with no underdrain or at least 24 inches of filter media and an infiltration sump. Enhanced designs receive 100% retention value

for the amount of  $S_v$  provided by the practice (Table 3-25), and are considered an accepted TSS treatment practice.

**Table 3-25 Enhanced Bioretention Retention Value and Pollutant Removal**

Retention Value	= $S_v$
Accepted TSS Treatment Practice	Yes

**Standard Designs.** These designs are bioretention applications with an underdrain and at least 18 inches of filter media. Standard designs receive 60% retention value and are an accepted TSS removal practice for the amount of storage volume ( $S_v$ ) provided by the practice (

Table 3-26).

**Table 3-26 Standard Bioretention Design Retention Value and Pollutant Removal**

Retention Value	= $0.6 \times S_v$
Accepted TSS Treatment Practice	Yes

Note: Additional retention value can be achieved if trees are utilized as part of a bioretention area (see Section 3.14, “Tree Planting and Preservation”).

Bioretention also contributes to peak flow reduction. This contribution can be determined in several ways. One method is to subtract the storage volume ( $S_v$ ) from the total runoff volume for the 2-year, 15-year, and 100-year storms. The resulting reduced runoff volumes can then be used to calculate a reduced NRCS CN for the site or SDA. The reduced NRCS CN can then be used to calculate peak flow rates for the various storm events. Other hydrologic modeling tools that employ different procedures may be used as well.

### 3.6.9 References

ASTM C295 / C295M-12, Standard Guide for Petrographic Examination of Aggregates for Concrete, ASTM International, West Conshohocken, PA, 2012, [www.astm.org](http://www.astm.org)

ASTM D448-12(2017), Standard Classification for Sizes of Aggregate for Road and Bridge Construction, ASTM International, West Conshohocken, PA, 2017, [www.astm.org](http://www.astm.org)

ASTM D2434-68(2006), Standard Test Method for Permeability of Granular Soils (Constant Head) (Withdrawn 2015), ASTM International, West Conshohocken, PA, 2006, [www.astm.org](http://www.astm.org)

- Cappiella, K., T. Schueler and T. Wright. 2006. Urban Watershed Forestry Manual: Part 2: Conserving and Planting Trees at Development Sites. USDA Forest Service. Center for Watershed Protection. Ellicott City, MD.
- CWP. 2007. National Pollutant Removal Performance Database, Version 3.0. Center for Watershed Protection, Ellicott City, MD.
- District of Columbia Department of Transportation (DDOT) Design and Engineering Manual, 2017. [https://ddot.dc.gov/sites/default/files/dc/sites/ddot/publication/attachments/2017-06-30\\_DDOT\\_DEM.pdf](https://ddot.dc.gov/sites/default/files/dc/sites/ddot/publication/attachments/2017-06-30_DDOT_DEM.pdf)
- District of Columbia Water and Sewer Authority (DC Water) Green Infrastructure Utility Protection Guidelines, 2013. <https://www.dewater.com/sites/default/files/Green%20Infrastructure%20Utility%20Protection%20Guidelines.pdf>
- Hirschman, D., L. Woodworth and S. Drescher. 2009. Technical Report: Stormwater BMPs in Virginia's James River Basin – An Assessment of Field Conditions and Programs. Center for Watershed Protection. Ellicott City, MD.
- Hunt, W.F. III and W.G. Lord. 2006. "Bioretention Performance, Design, Construction, and Maintenance." North Carolina Cooperative Extension Service Bulletin. Urban Waterways Series. AG-588-5. North Carolina State University. Raleigh, NC.
- Maryland Department of the Environment. 2001. Maryland Stormwater Design Manual. [http://mde.maryland.gov/programs/Water/StormwaterManagementProgram/Pages/stormwater\\_design.aspx](http://mde.maryland.gov/programs/Water/StormwaterManagementProgram/Pages/stormwater_design.aspx)
- Prince George's Co., MD. 2007. Bioretention Manual.
- Recommended Soil Testing Procedures for the Northeastern United States. 3<sup>rd</sup> ed., Northeast Regional Publication, Agricultural Experiment Station Bulletin 493, University of Delaware, Newark.
- Saxton, K.E., W.J. Rawls, J.S. Romberger, and R.I. Papendick. 1986. "Estimating generalized soil-water characteristics from texture." Soil Sci. Soc. Am. J. 50(4):1031-1036. Schueler, T. 2008. Technical Support for the Baywide Runoff Reduction Method. Chesapeake Stormwater Network. Baltimore, MD. <http://chesapeakestormwater.net/>
- Smith, R.A. and Hunt, W.F. III. 1999. "Pollutant Removal in Bioretention Cells with Grass Cover"
- Smith, R. A., and Hunt, W.F. III. 2007. "Pollutant removal in bioretention cells with grass cover." Pp. 1-11 In: Proceedings of the World Environmental and Water Resources Congress 2007.
- Sumner, M. E. and W. P. Miller. 1996. Cation Exchange Capacity and Exchange Coefficients. Methods of Soil Analysis, Part 3 – Chemical Methods: 1201-1229

Virginia DCR Stormwater Design Specification No. 9: Bioretention Version 1.8. 2010.

Wisconsin Department of Natural Resources. *Storm Water Post-Construction Technical Standards*. [http://dnr.wi.gov/topic/stormwater/standards/postconst\\_standards.html](http://dnr.wi.gov/topic/stormwater/standards/postconst_standards.html)

### 3.7 Filtering Systems

**Definition.** Practices that capture and temporarily store the design storm volume and pass it through a filter bed of sand media. Filtered runoff may be collected and returned to the conveyance system or allowed to partially infiltrate into the soil. Design variants include the following:

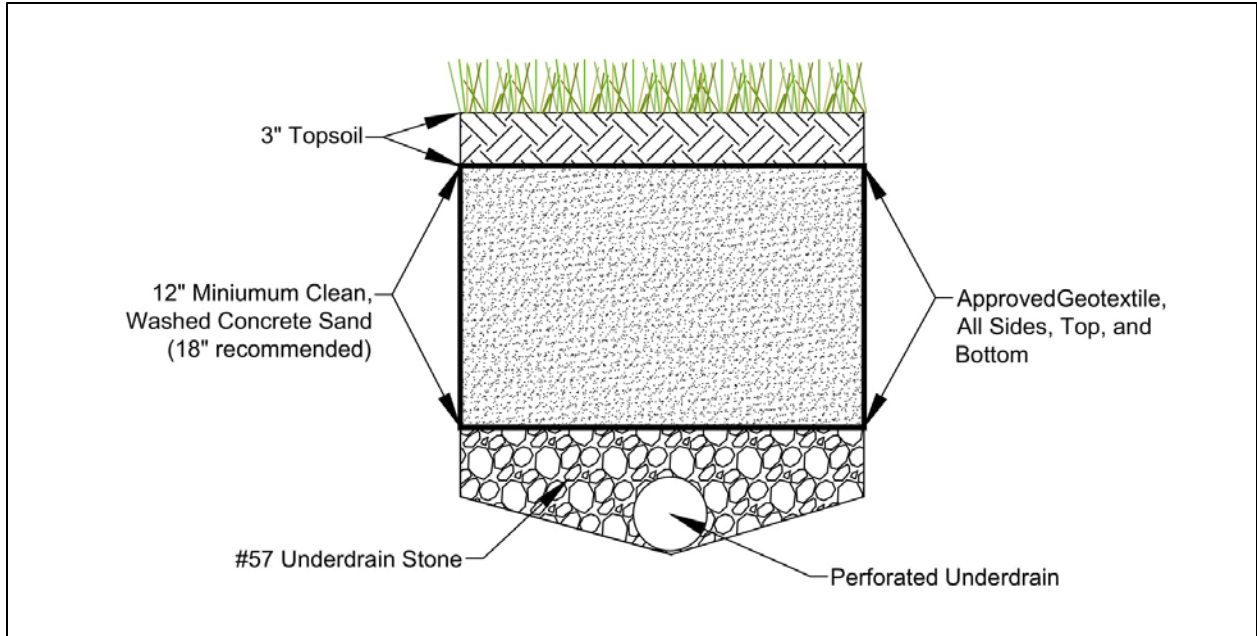
- F-1 Nonstructural sand filter
- F-2 Surface sand filter
- F-3 Three-chamber underground sand filter
- F-4 Perimeter sand filter

Stormwater filters are a useful practice to treat stormwater runoff from small, highly impervious sites. Stormwater filters capture, temporarily store, and treat stormwater runoff by passing it through an engineered filter media, collecting the filtered water in an underdrain, and then returning it back to the storm drainage system.

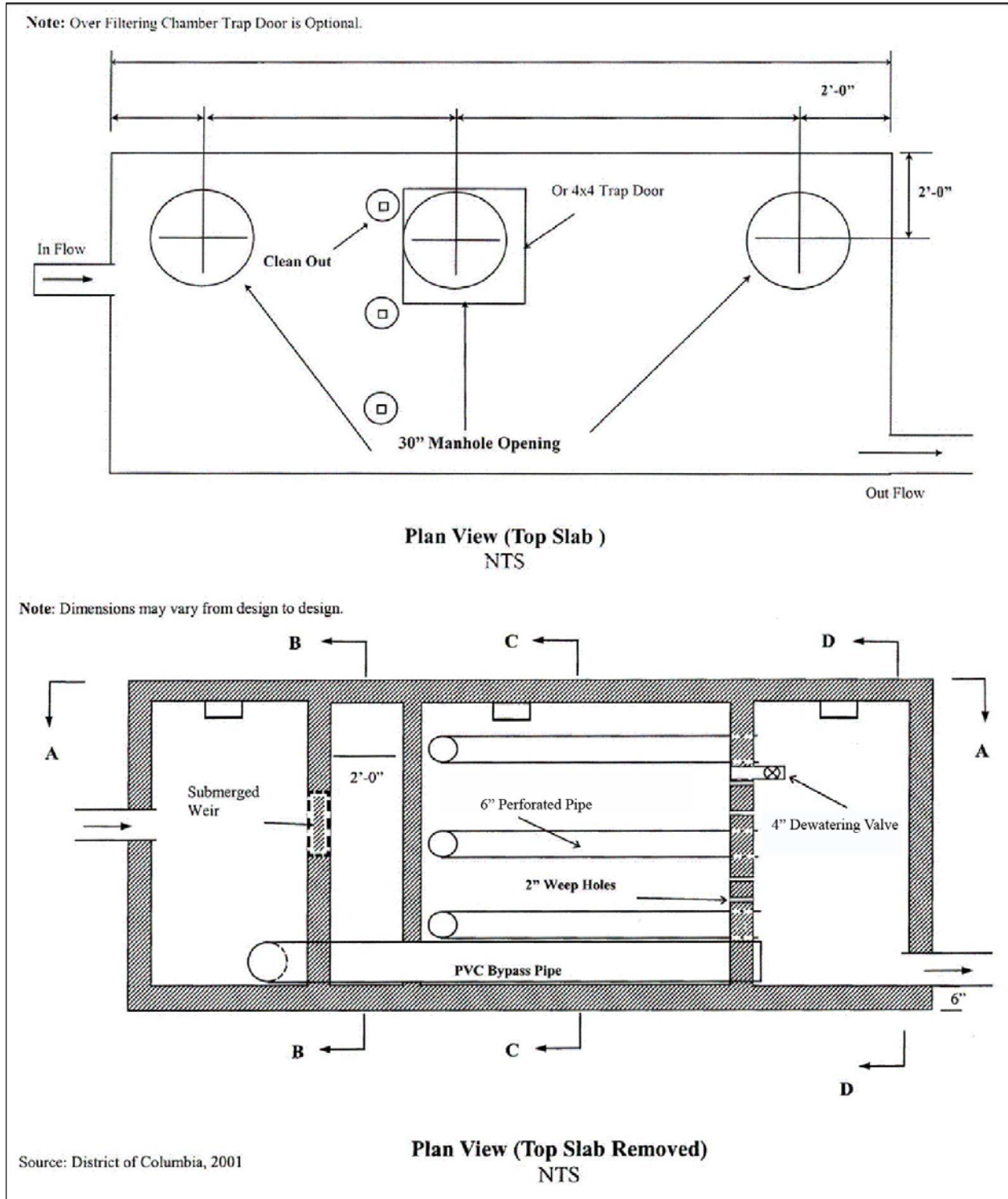
Stormwater filters are a versatile option because they consume very little surface land and have few site restrictions. They provide moderate pollutant removal performance at small sites where space is limited. However, filters have no retention capability, so designers should consider using up-gradient retention practices, which have the effect of decreasing the design storm volume and size of the filtering practices. Filtering practices are also suitable to provide special treatment at designated stormwater hotspots. A list of potential stormwater hotspots operations can be found in Appendix Q - Stormwater Hotspots.

Filtering systems are typically not designed to provide stormwater detention ( $Q_{p2}$ ,  $Q_{p15}$ ), but they may be in some circumstances. Filtering practices are generally combined with separate facilities to provide this type of control. However, the three-chamber underground sand filter can be modified by expanding the first or settling chamber, or adding an extra chamber between the filter chamber and the clear well chamber to handle the detention volume, which is subsequently discharged at a predetermined rate through an orifice and weir combination.

A surface sand filter is depicted in Figure 3.25, while Figure 3.26 through Figure 3.31 depict three-chamber underground sand filters. Figure 3.32 depicts a perimeter sand filter.



**Figure 3.25 Typical schematic for a surface sand filter (F-2). Note: Material specifications are indicated in Table 3-27.**



**Figure 3.26 Part A – Example of a three-chamber underground sand filter (F-3) for separate sewer areas. Note: Material specifications are indicated in Table 3-27.**

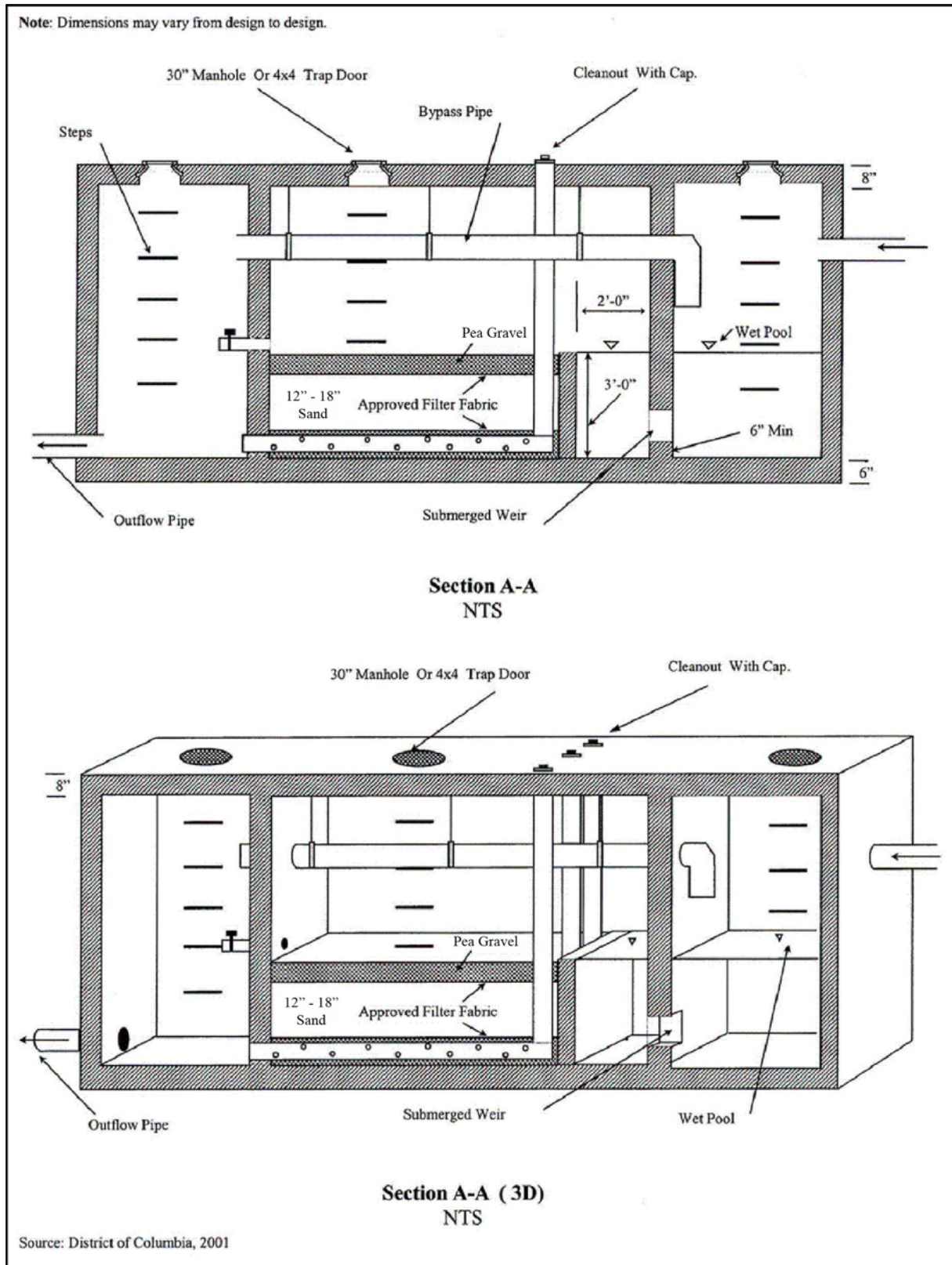


Figure 3.27 Part B – Example of a three-chamber underground sand filter (F-3) for separate sewer areas. Note: Material specifications are indicated in Table 3.27.



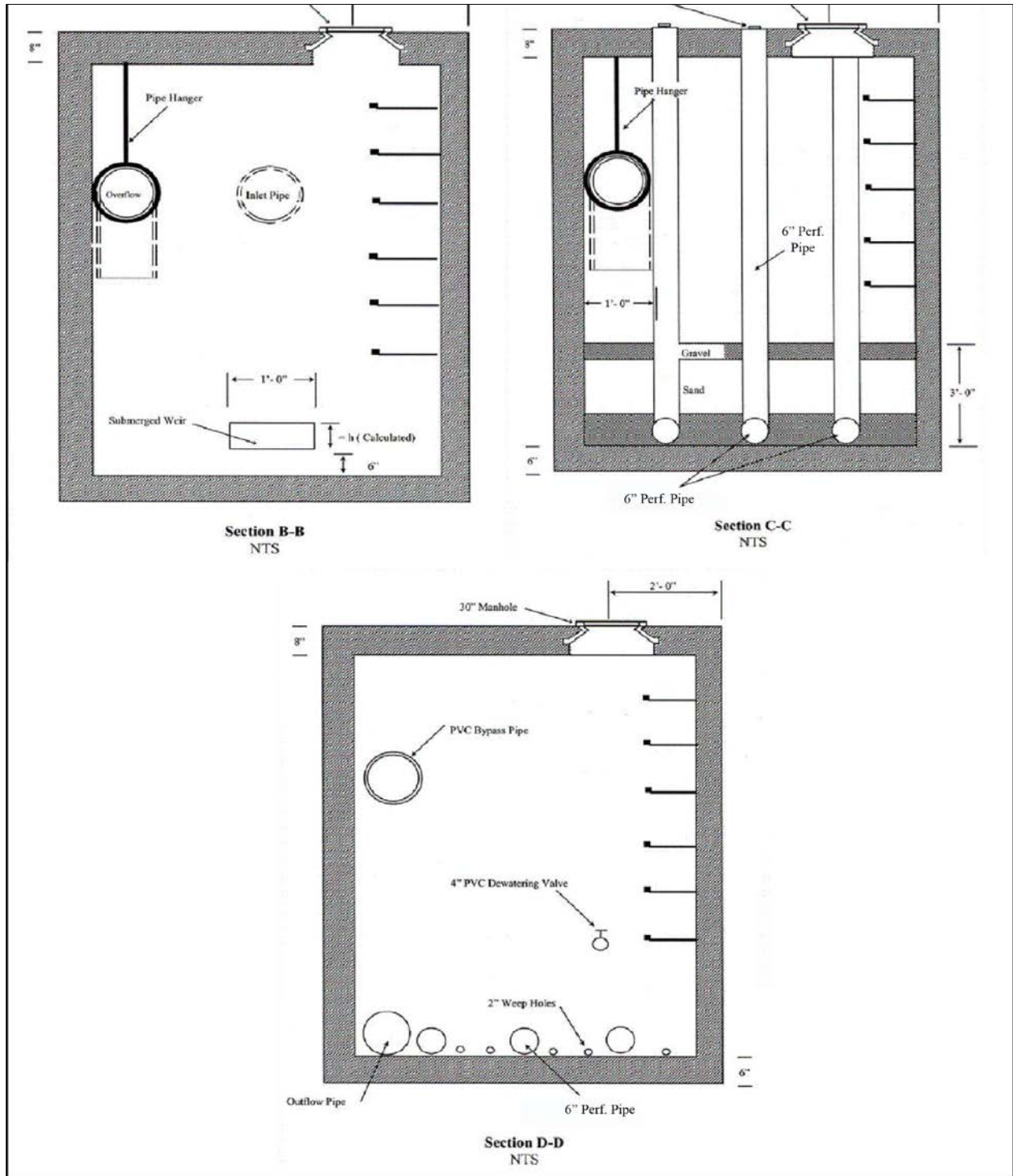
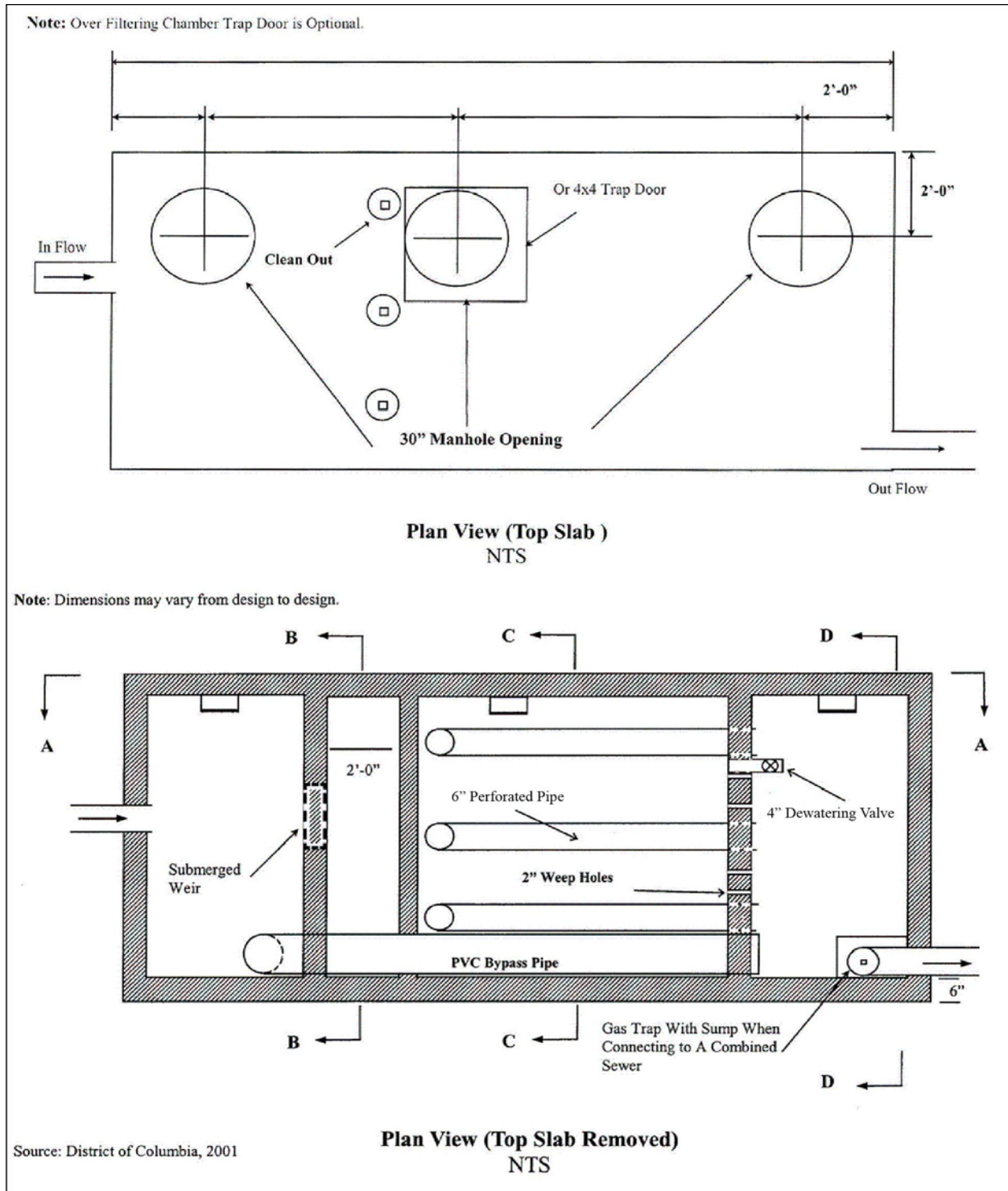


Figure 3.28 Part C – Example of a three-chamber underground sand filter (F-3) for separate sewer areas. Note: Material specifications are indicated in Table 3.27.



**Figure 3.29 Part A – Example of a three-chamber underground sand filter (F-3) for combined sewer areas. Note: Material specifications are indicated in Table 3.27.**

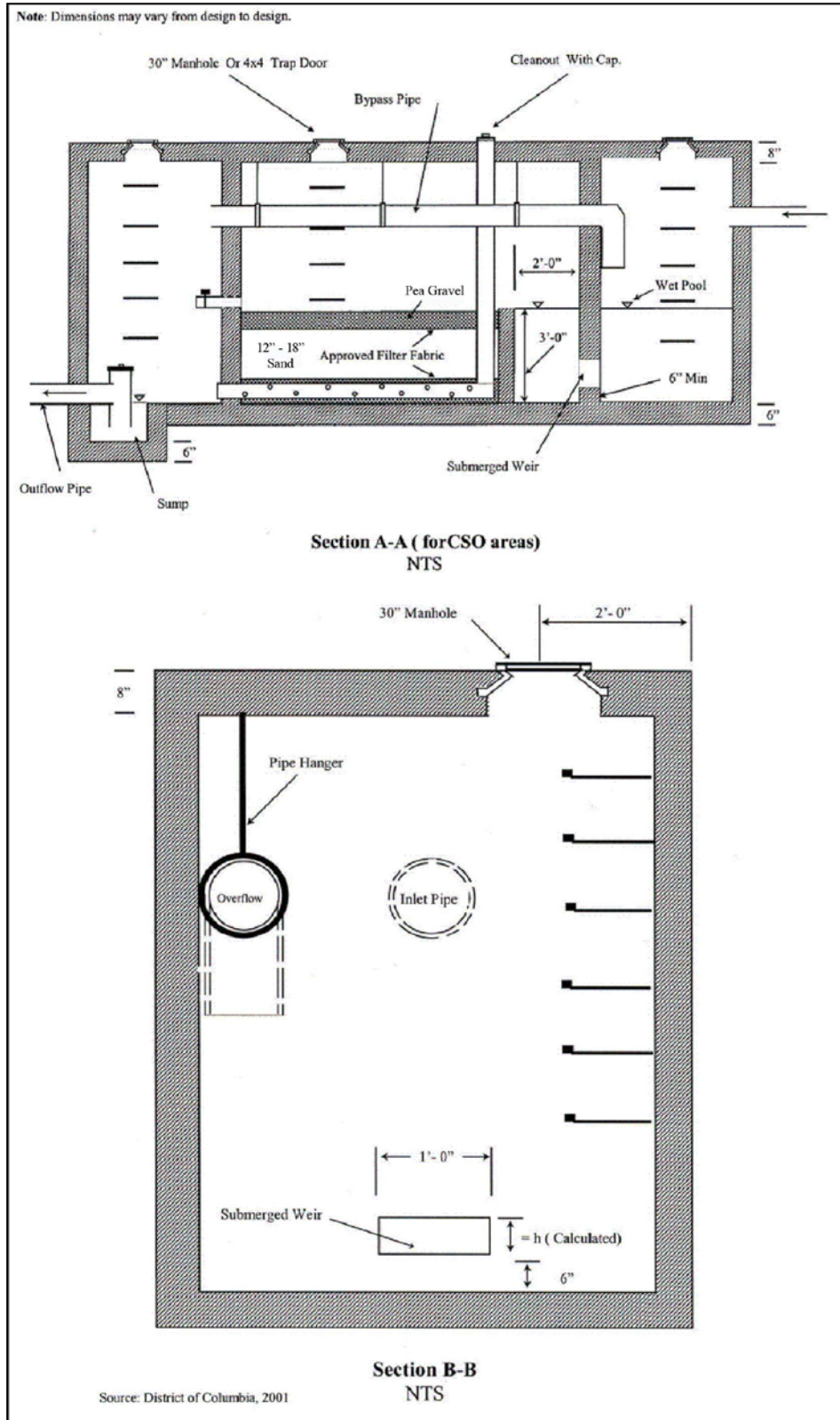
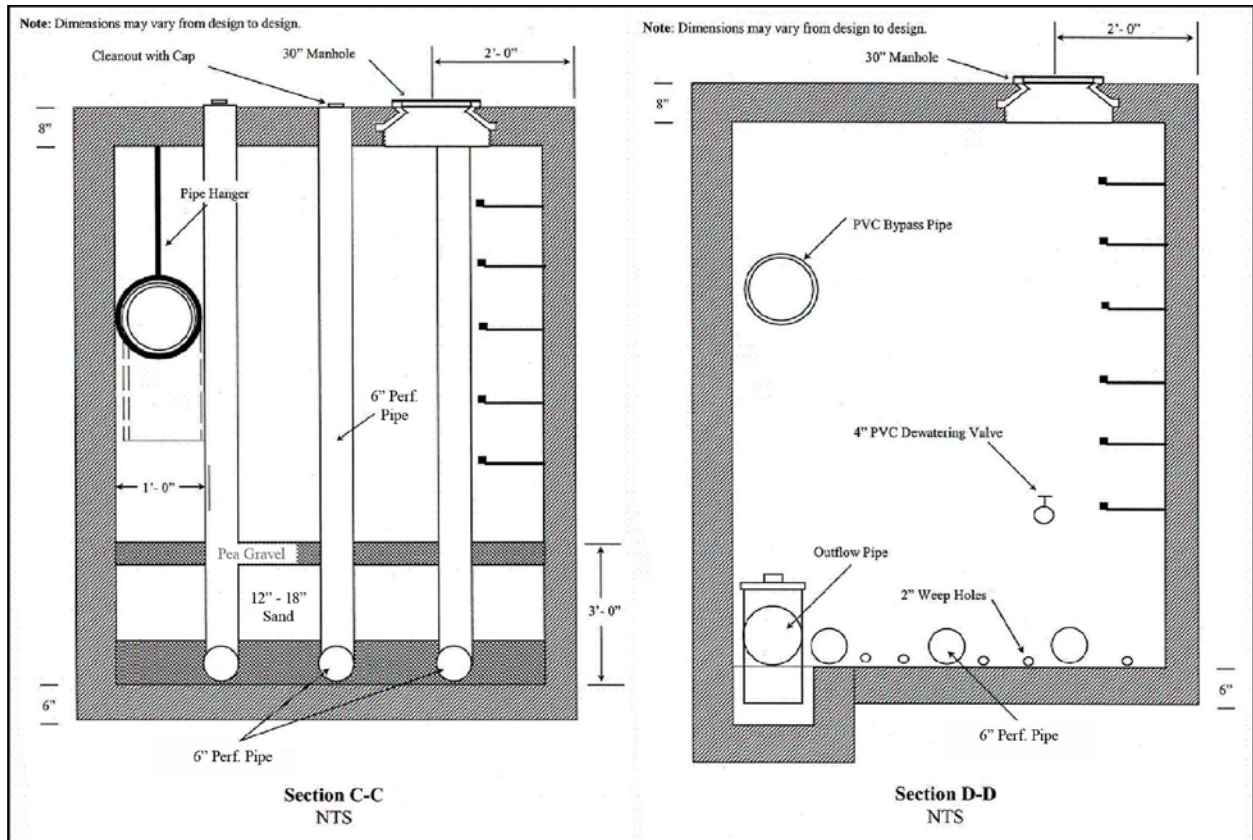


Figure 3.30 Part B – Example of a three-chamber underground sand filter (F-3) for combined sewer areas. Note: Material specifications are indicated in Table 3.27.



**Figure 3.31 Part C – Example of a three-chamber underground sand filter (F-3) for combined sewer areas. Note: Material specifications are indicated in Table 3.27.**

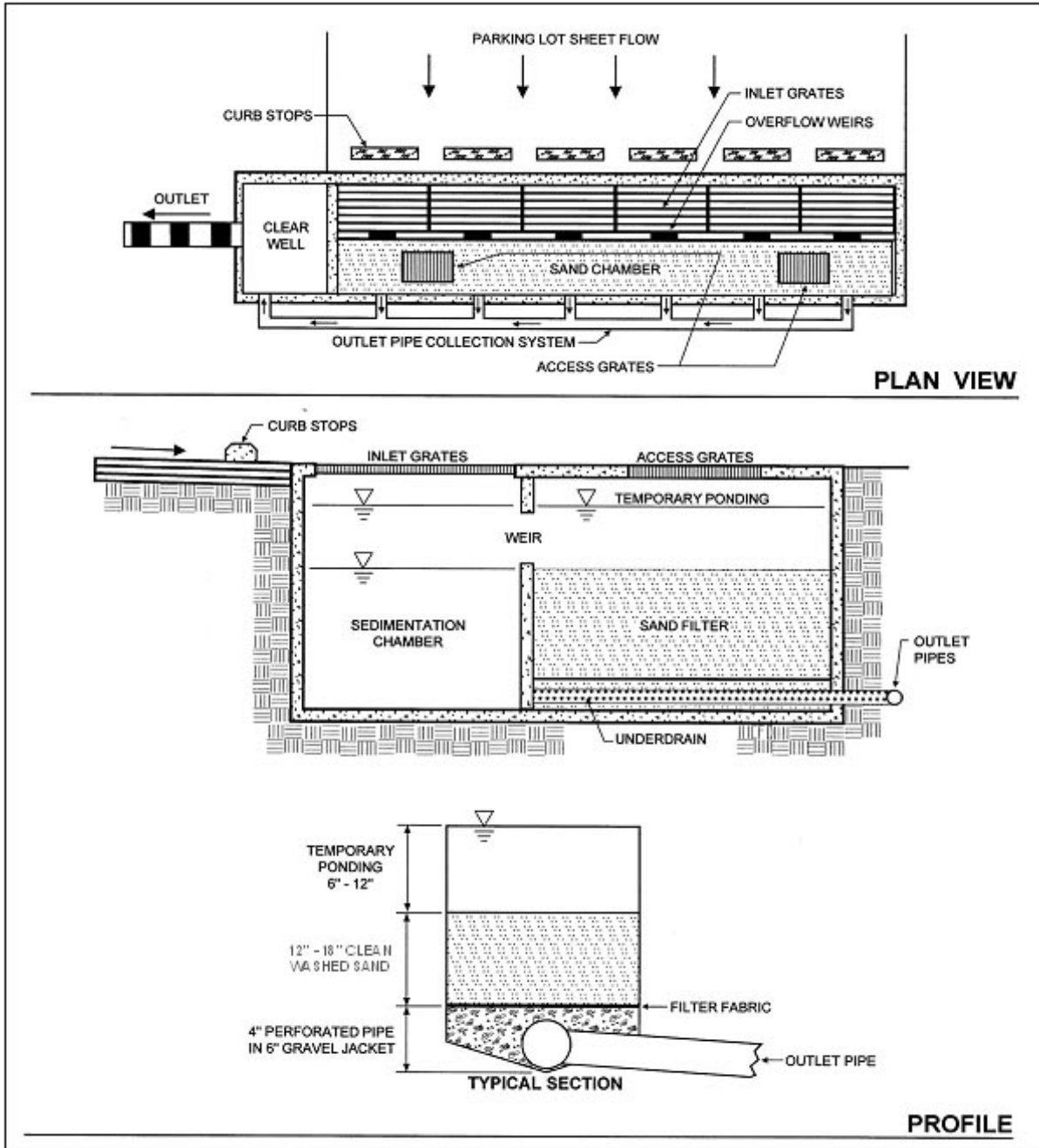


Figure 3.32 Example of a perimeter sand filter (F-4).

### 3.7.1 Filtering Feasibility Criteria

Stormwater filters can be applied to most types of urban land. They are not always cost-effective, given their high unit cost and small area served, but there are situations where they may clearly be the best option for stormwater treatment (e.g., hotspot runoff treatment, small parking lots, ultra-urban areas, etc.). The following criteria apply to filtering practices:

**Available Hydraulic Head.** The principal design constraint for stormwater filters is available hydraulic head, which is defined as the vertical distance between the top elevation of the filter and the bottom elevation of the existing storm drain system that receives its discharge. The head required for stormwater filters ranges from 2 to 10 feet, depending on the design variant. It is difficult to employ filters in extremely flat terrain, since they require gravity flow through the filter. The only exception is the perimeter sand filter, which can be applied at sites with as little as 2 feet of head.

**Depth to Water Table and Bedrock.** The designer must assure a standard separation distance of at least 2 feet between the groundwater table and/or bedrock layer and the bottom invert of the filtering practice.

**Contributing Drainage Area.** Filters are best applied on small sites where the CDA is as close to 100% impervious as possible in order to reduce the risk that eroded sediment will clog the filter. If the CDA is pervious, then the vegetation must be dense and stable. Turf is acceptable (see Section 3.7.5 Filtering Landscaping Criteria). A maximum CDA of 5 acres is recommended for surface sand filters, and a maximum CDA of 2 acres is recommended for perimeter or underground filters. Filters have been used on larger CDAs in the past, but greater clogging problems have typically resulted.

**Space Required.** The amount of space required for a filter practice depends on the design variant selected. Surface sand filters typically consume about 2%–3% of the CDA, while perimeter sand filters typically consume less than 1%. Underground stormwater filters generally consume no surface area except their manholes.

**Land Use.** As noted above, filters are particularly well suited to treat runoff from stormwater hotspots and smaller parking lots. Other applications include redevelopment of commercial sites or when existing parking lots are renovated or expanded. Filters can work on most commercial, industrial, institutional, or municipal sites and can be located underground if surface area is not available.

**Site Topography.** Filters shall not be located on slopes greater than 6%.

**Utilities.** All utilities shall have a minimum 5-foot, horizontal clearance from the filtering practice.

**Facility Access.** All filtering systems shall be located in areas where they are accessible for inspection and for maintenance (by vacuum trucks).

**Soils.** Soil conditions do not constrain the use of filters. At least one soil boring must be taken at a low point within the footprint of the proposed filtering practice to establish the water table and

bedrock elevations and evaluate soil suitability. A geotechnical investigation is required for all underground stormwater BMPs, including underground filtering systems. Geotechnical testing requirements are outlined in Appendix P - Geotechnical Information Requirements for Underground BMPs.

### **3.7.2 Filtering Conveyance Criteria**

Most filtering practices are designed as off-line systems so that all flows enter the filter storage chamber until it reaches capacity, at which point larger flows are then diverted or bypassed around the filter to an outlet chamber and are not treated. Runoff from larger storm events must be bypassed using an overflow structure or a flow splitter. Claytor and Schueler (1996) and ARC (2001) provide design guidance for flow splitters for filtering practices.

Some underground filters will be designed and constructed as on-line BMPs. In these cases, designers must indicate how the device will safely pass larger storm events (e.g., the 15-year event) to a stabilized water course without resuspending or flushing previously trapped material.

All stormwater filters must be designed to drain or dewater within 40 hours (1.67 days) after a storm event to reduce the potential for nuisance conditions.

### **3.7.3 Filtering Pretreatment Criteria**

Adequate pretreatment is needed to prevent premature filter clogging and ensure filter longevity. Dry or wet pretreatment shall be provided prior to filter media. Pretreatment devices are subject to the following criteria:

- Sedimentation chambers are typically used for pretreatment to capture coarse sediment particles before they reach the filter bed.
- Sedimentation chambers may be wet or dry but must be sized to accommodate at least 25% of the total design storm volume (inclusive).
- Sediment chambers should be designed as level spreaders such that inflows to the filter bed have near zero velocity and spread runoff evenly across the bed.
- Nonstructural and surface sand filters may use alternative pretreatment measures, such as a grass filter strip, forebay, gravel diaphragm, check dam, level spreader, or a combination of these. The grass filter strip must be a minimum length of 15 feet and have a slope of 3% or less. The check dam may be wooden or concrete and must be installed so that it extends only 2 inches above the filter strip and has lateral slots to allow runoff to be evenly distributed across the filter surface. Alternative pretreatment measures must contain a non-erosive flow path that distributes the flow evenly over the filter surface. If a forebay is used, it must be designed to accommodate at least 25% of the total design storm volume (inclusive).

### **3.7.4 Filtering Design Criteria**

**Detention time.** All filter systems must be designed to drain the design storm volume from the filter chamber within 40 hours (1.67 days) after each rainfall event.

**Structural Requirements.** If a filter will be located underground or experience traffic loads, a licensed structural engineer must certify the structural integrity of the design.

**Geometry.** Filters are gravity flow systems that normally require 2 to 5 feet of driving head to push the water through the filter media through the entire maintenance cycle; therefore, sufficient vertical clearance between the inverts of the inflow and outflow pipes is required.

**Type of Filter Media.** The normal filter media consists of clean, washed AASHTO M-6/ASTM C-33 medium aggregate concrete sand with individual grains 0.02 to 0.04 inch in diameter.

**Depth of Filter Media.** The depth of the filter media plays a role in how quickly stormwater moves through the filter bed and how well it removes pollutants. The recommended filter bed depth is 18 inches. An absolute minimum filter bed depth of 12 inches above underdrains is required; although, designers should note that specifying the minimum depth of 12 inches will incur a more intensive maintenance schedule and possibly result in costlier maintenance.

**Underdrain and Liner.** Stormwater filters are normally designed with an impermeable liner and underdrain system that meet the criteria provided in Table 3.27 below.

**Underdrain Stone.** The underdrain should be covered by a minimum 6-inch gravel layer consisting of No. 57 stone. Stone must be washed clean and free of fines (no more than 2% passing the No. 200 sieve).

**Type of Filter.** There are several design variations of the basic filter that enable designers to use filters at challenging sites or to improve pollutant removal rates. The choice of which filter design to apply depends on available space, hydraulic head, and the level of pollutant removal desired. In ultra-urban situations where surface space is at a premium, underground sand filters are often the only design that can be used. Surface and perimeter filters are often a more economical choice when adequate surface area is available. The most common design variants include the following:

- **Nonstructural Sand Filter (F-1).** The nonstructural sand filter is applied to sites less than 2 acres in size and is very similar to a bioretention practice (see Section 3.6 Bioretention), with the following exceptions:
  - ◆ The bottom is lined with an impermeable liner and always has an underdrain.
  - ◆ The surface cover is sand, turf, or pea gravel.
  - ◆ The filter media is 100% sand.
  - ◆ The filter surface is not planted with trees, shrubs, or herbaceous materials.
  - ◆ The filter has two cells, with a dry or wet sedimentation chamber preceding the sand filter bed.

The nonstructural sand filter is the least expensive filter option for treating hotspot runoff. The use of bioretention areas is generally preferred at most other sites.

- **Surface Sand Filter (F-2).** The surface sand filter is designed with both the filter bed and sediment chamber located at ground level. The most common filter media is sand; however, a



peat/sand mixture may be used to increase the removal efficiency of the system. In most cases, the filter chambers are created using precast or cast-in-place concrete. Surface sand filters are normally designed to be off-line facilities, so that only the desired design volume is directed to the filter for treatment. However, in some cases they can be installed on the bottom of a dry pond (see Section 3.12 Storage Practices).

- **Underground Sand Filter.** The underground sand filter is modified to install the filtering components underground and is often designed with an internal flow splitter or overflow device that bypasses runoff from larger stormwater events around the filter. Underground sand filters are expensive to construct, but they consume very little space and are well suited to ultra-urban areas.
- **Three-Chamber Underground Sand Filter (F-3).** The three-chamber underground sand filter is a gravity flow system. The facility may be precast or cast-in-place. The first chamber acts as a pretreatment facility removing any floating organic material such as oil, grease, and tree leaves. It should have a submerged orifice leading to a second chamber, and it should be designed to minimize the energy of incoming stormwater before the flow enters the second chamber (i.e., filtering or processing chamber).

The second chamber is the filtering or processing chamber. It should contain the filter material consisting of gravel and sand and should be situated behind a weir. Along the bottom of the structure should be a subsurface drainage system consisting of a parallel perforated PVC pipe system in a stone bed. A dewatering valve should be installed at the top of the filter layer for safety release in cases of emergency. A bypass pipe crossing the second chamber to carry overflow from the first chamber to the third chamber is required.

The third chamber is the discharge chamber. It should also receive the overflow from the first chamber through the bypass pipe when the storage volume is exceeded.

Water enters the first chamber of the system by gravity or by pumping. This chamber removes most of the heavy solid particles, floatable trash, leaves, and hydrocarbons. Then the water flows to the second chamber and enters the filter layer by overtopping a weir. The filtered stormwater is then picked up by the subsurface drainage system that empties it into the third chamber.

Whenever there is insufficient hydraulic head for a three-chamber underground sand filter, a well pump may be used to discharge the effluent from the third chamber into the receiving storm or combined sewer. For three-chamber sand filters in combined-sewer areas, a water trap shall be provided in the third chamber to prevent the back flow of odorous gas.

A design example for a three-chamber underground sand filter is provided in Appendix U - Underground Sand Filter Design Example.

- **Perimeter Sand Filter (F-4).** The perimeter sand filter also includes the basic design elements of a sediment chamber and a filter bed. The perimeter sand filter typically consists of two parallel trenches connected by a series of overflow weir notches at the top of the partitioning wall, which allows water to enter the second trench as sheet flow. The first trench is a pretreatment chamber removing heavy sediment particles and debris. The second trench consists of the sand filter layer. A subsurface drainage pipe must be installed at the bottom of the second chamber to facilitate the filtering process and convey filter water into a receiving system.

In this design, flow enters the system through grates, usually at the edge of a parking lot. The perimeter sand filter is usually designed as an on-line practice (i.e., all flows enter the system), but larger events bypass treatment by entering an overflow chamber. One major advantage of the perimeter sand filter design is that it requires little hydraulic head and is therefore a good option for sites with low topographic relief.

**Surface Cover.** The surface cover for nonstructural and surface sand filters should consist of a 3-inch layer of topsoil on top of the sand layer. The surface may also have pea gravel inlets in the topsoil layer to promote filtration. The pea gravel may be located where sheet flow enters the filter, around the margins of the filter bed, or at locations in the middle of the filter bed.

Underground sand filters should have a pea gravel or No. 57 stone layer on top of the sand layer. This gravel layer helps to prevent bio-fouling or blinding of the sand surface.

**Maintenance Reduction Features.** The following maintenance issues should be addressed during filter design to reduce future maintenance problems:

- **Observation Wells and Cleanouts.** Nonstructural and surface sand filters must include an observation well consisting of a 6-inch diameter non-perforated PVC pipe fitted with a lockable cap. It should be installed flush with the ground surface to facilitate periodic inspection and maintenance. In most cases, a cleanout pipe will be tied into the end of all underdrain pipe runs. The portion of the cleanout pipe/observation well in the underdrain layer should be perforated. At least one cleanout pipe must be provided for every 2,000 square feet of filter surface area.
- **Access.** Good maintenance access is needed to allow crews to perform regular inspections and maintenance activities. “Sufficient access” is operationally defined as the ability to get a vacuum truck or similar equipment close enough to the sedimentation chamber and filter to enable cleanouts. Direct maintenance access shall be provided to the pretreatment area and the filter bed. For underground structures, sufficient headroom for maintenance should be provided. A minimum head space of 5 feet above the filter is recommended for maintenance of the structure. However, if 5 feet of headroom is not available, manhole access must be installed.
- **Manhole Access (for underground filters).** Access to the headbox and clearwell of Underground Filters must be provided by manholes at least 30 inches in diameter, along with steps to the areas where maintenance will occur.
- **Visibility.** Stormwater filters should be clearly visible at the site so inspectors and maintenance crews can easily find them. Adequate signs or markings must be provided at manhole access points for Underground Filters.
- **Confined Space Issues.** Underground filters are often classified as a confined space. Consequently, special OSHA rules apply, and training may be needed to protect the workers that access them. These procedures often involve training about confined space entry, venting, and the use of gas probes.

**Filter Material Specifications.** The basic material specifications for filtering practices that utilize sand as a filter media are outlined in Table 3.27.

**Table 3-27 Filtering Practice Material Specifications**

Material	Specification
Surface Cover	Nonstructural and surface sand filters: 3-inch layer of topsoil on top of the sand layer. The surface may also have pea gravel inlets in the topsoil layer to promote filtration.  Underground sand filters: Pea gravel or No. 57 stone on top of the sand layer. Stone must be washed clean and free of fines (no more than 2% passing the No. 200 sieve).
Sand	Clean AASHTO M-6/ASTM C-33 medium aggregate concrete sand with a particle size range of 0.02–0.04 inch in diameter.
Choker Stone and/or Geotextile/Filter Fabric	For choker stone, a 2- to 4-inch layer of choker stone (e.g., typically ASTM D448 No. 8 or No. 89 gravel) should be placed between the sand layer and the underdrain stone. Alternatively, if available head is limited, an appropriate geotextile fabric that meets AASHTO M-288 Class 2, latest edition, requirements may be used. The geotextile fabric must have a flow rate of > 125 gpm/ft <sup>2</sup> (ASTM D4491) and an Apparent Opening Size (AOS) equivalent to a US No. 70 or No. 80 sieve. Stone must be washed clean and free of fines (no more than 2% passing the No. 200 sieve).
Underdrain/Perforated Pipe	4- or 6-inch perforated schedule 40 PVC pipe, with three or four rows of 3/8-inch perforations at 6 inches on center.
Underdrain Stone	Use No. 57 stone or the ASTM equivalent (1-inch maximum). Stone must be washed clean and free of fines (no more than 2% passing the No. 200 sieve).
Impermeable Liner	Where appropriate, use a PVC Geomembrane liner or equivalent.

**Filter Sizing.** Filtering devices are sized to accommodate a specified design storm volume (typically SWR<sub>v</sub>). The volume to be treated by the device is a function of the storage depth above the filter and the surface area of the filter. The storage volume is the volume of ponding above the filter. For a given design volume, Equation 3.8 is used to determine the required filter surface area.

#### Equation 3.8 Minimum Filter Surface Area for Filtering Practices

$$SA_{filter} = \frac{DesignVolume \times d_f}{k \times (h_{avg} + d_f) \times t_d}$$

where:

$SA_{filter}$	=	area of the filter surface (ft <sup>2</sup> )
$DesignVolume$	=	design storm volume, typically the SWR <sub>v</sub> (ft <sup>3</sup> )
$d_f$	=	filter media depth (thickness) (ft), with a minimum of 1 ft
$k$	=	coefficient of permeability (ft/day) (3.5 ft/day for partially clogged sand)
$h_f$	=	height of water above the filter bed (ft), with a maximum of 5 ft
$h_{avg}$	=	average height of water above the filter bed (ft), one half of the filter height ( $h_f$ )

$$t_d = \text{allowable drawdown time (1.67 days)}$$

The coefficient of permeability (ft/day) is intended to reflect the worst-case situation (i.e., the condition of the sand media at the point in its operational life where it is in need of replacement or maintenance). Filtering practices are therefore sized to function within the desired constraints at the end of the media's operational life cycle.

The entire filter treatment system, including pretreatment, shall temporarily hold at least 50% of the design storm volume prior to filtration (see Equation 3.9). This reduced volume takes into account the varying filtration rate of the water through the media, as a function of a gradually declining hydraulic head.

**Equation 3.9 Required Ponding Volume for Filtering Practices**

$$V_{ponding} = 0.50 \times DesignVolume$$

where:

$$\begin{aligned} V_{ponding} &= \text{storage volume required prior to filtration (ft}^3\text{)} \\ DesignVolume &= \text{design storm volume, typically the SWRv (ft}^2\text{)} \end{aligned}$$

The total storage volume for the practice (Sv) can be determined using Equation 3.10 below.

**Equation 3.10 Storage Volume for Filtering Practices**

$$Sv = 2.0 \times V_{ponding}$$

where:

$$\begin{aligned} Sv &= \text{total storage volume for the practice (ft}^3\text{)} \\ V_{ponding} &= \text{storage volume required prior to filtration (ft}^3\text{)} \end{aligned}$$

**3.7.5 Filtering Landscaping Criteria**

A dense and vigorous vegetative cover shall be established over the contributing pervious drainage areas before runoff can be accepted into the facility. Filtering practices should be incorporated into site landscaping to increase their aesthetics and public appeal.

Surface filters (e.g., surface and nonstructural sand filters) can have a grass cover to aid in pollutant adsorption. The grass should be capable of withstanding frequent periods of inundation and drought.

### 3.7.6 Filter Construction Sequence

**Soil Erosion and Sediment Control.** No runoff shall be allowed to enter the filter system prior to completion of all construction activities, including revegetation and final site stabilization. Construction runoff shall be treated in separate sedimentation basins and routed to bypass the filter system. Should construction runoff enter the filter system prior to final site stabilization, all contaminated materials must be removed and replaced with new clean filter materials before a regulatory inspector approves its completion. The approved soil erosion and sediment control plan shall include specific measures to provide for the protection of the filter system before the final stabilization of the site.

**Filter Installation.** The following is the typical construction sequence to properly install a structural sand filter. This sequence can be modified to reflect different filter designs, site conditions, and the size, complexity, and configuration of the proposed filtering application.

**Step 1: Stabilize Contributing Drainage Area.** Filtering practices should only be constructed after the CDA to the facility is completely stabilized, so sediment from the CDA does not flow into and clog the filter. If the proposed filtering area is used as a sediment trap or basin during the construction phase, the construction notes should clearly specify that, after site construction is complete, the sediment control facility will be dewatered, dredged, and regraded to design dimensions for the post-construction filter.

**Step 2: Install Soil Erosion and Sediment Control Measures for the Filtering Practice.** Stormwater should be diverted around filtering practices as they are being constructed. This is usually not difficult to accomplish for off-line filtering practices. It is extremely important to keep runoff and eroded sediment away from the filter throughout the construction process. Silt fence or other sediment controls should be installed around the perimeter of the filter, and erosion control fabric may be needed during construction on exposed side-slopes with gradients exceeding 4H:1V. Exposed soils in the vicinity of the filtering practice should be rapidly stabilized by hydro-seed, sod, mulch, or other method.

**Step 3: Assemble Construction Materials On Site.** Inspect construction materials to ensure they conform to design specifications and prepare any staging areas.

**Step 4: Clear and Strip.** Bring the project area to the desired subgrade.

**Step 5: Excavate and Grade.** Survey to achieve the appropriate elevation and designed contours for the bottom and side slopes of the filtering practice.

**Step 6: Install Filter Structure.** Install filter structure in design location and check all design elevations (i.e., concrete vaults for surface, underground, and perimeter sand filters). Upon completion of the filter structure shell, inlets and outlets must be temporarily plugged and the structure filled with water to the brim to demonstrate water tightness. Maximum allowable leakage is 5% of the water volume in a 24-hour period. See Appendix L - Construction Inspection Checklists for the Stormwater Management Standard Testing form. If the structure fails the test, repairs must be performed to make the structure watertight before any sand is placed into it.

**Step 7: Install Base Material Components.** Install the gravel, underdrains, and choker layers of the filter.

**Step 8: Install Top Sand Component.** Spread sand across filter bed in 1-foot lifts up to the design elevation. Backhoes or other equipment can deliver the sand from outside the filter structure. Sand should be manually raked. Clean water is then added until the sedimentation chamber and filter bed are completely full. The facility is then allowed to drain, hydraulically compacting the sand layers. After 48 hours of drying, refill the structure to the final top elevation of the filter bed.

**Step 9: Install Surface Layer (Surface Sand Filters only).** Add a 3-inch topsoil layer and pea gravel inlets and immediately seed with the permanent grass species. The grass should be watered, and the facility should not be switched on-line until a vigorous grass cover has become established.

**Step 10: Stabilize Surrounding Areas.** Stabilize exposed soils on the perimeter of the structure with temporary seed mixtures appropriate for a buffer. All areas above the normal pool should be permanently stabilized by hydroseed, sod, or seeding and mulch.

**Step 11: Final Inspection.** Conduct the final construction inspection. Multiple construction inspections by a qualified professional are critical to ensure that stormwater filters are properly constructed. Inspections are recommended during the following stages of construction:

- Initial site preparation, including installation of soil erosion and sediment control measures;
- Excavation/grading to design dimensions and elevations;
- Installation of the filter structure, including the water tightness test;
- Installation of the underdrain and filter bed;
- Check that turf cover is vigorous enough to switch the facility on-line; and
- Final inspection after a rainfall event to ensure that it drains properly and all pipe connections are watertight. Develop a punch list for facility acceptance. Log the filtering practice's GPS coordinates and submit them for entry into the BMP maintenance tracking database.

DOEE's construction phase inspection checklist for filters and the Stormwater Management Standard Testing Record form can be found in Appendix L - Construction Inspection Checklists.

### **3.7.7 Filtering Maintenance Criteria**

Maintenance of filters is required and involves several routine maintenance tasks, which are outlined in Table 3-28. A cleanup should be scheduled at least once a year to remove trash and floatables that accumulate in the pretreatment cells and filter bed. Frequent sediment cleanouts in the dry and wet sedimentation chambers are recommended every 1 to 3 years to maintain the function and performance of the filter. If the filter treats runoff from a stormwater hotspot, crews may need to test the filter bed media before disposing of the media and trapped pollutants. Petroleum hydrocarbon contaminated sand or filter cloth must be disposed of according to District solid waste disposal regulations. Testing is not needed if the filter does not receive runoff from a designated stormwater hotspot, in which case the media can be safely disposed of in a landfill.

**Table 3-28 Typical Annual Maintenance Activities for Filtering Practices**

Frequency	Maintenance Tasks
At least 4 times per growing season	<ul style="list-style-type: none"> <li>▪ Mow grass filter strips and perimeter turf around surface sand filters. Maximum grass heights should be less than 12 inches.</li> </ul>
2 times per year (may be more or less frequently depending on land use)	<ul style="list-style-type: none"> <li>▪ Check to see if sediment accumulation in the sedimentation chamber has exceeded 6 inches. If so, schedule a cleanout.</li> </ul>
Annually	<ul style="list-style-type: none"> <li>▪ Conduct inspection and cleanup.</li> <li>▪ Dig a small test pit in the filter bed to determine whether the first 3 inches of sand are visibly discolored and need replacement.</li> <li>▪ Check to see if inlets and flow splitters are clear of debris and are operating properly.</li> <li>▪ Check concrete structures and outlets for any evidence of spalling, joint failure, leakage, corrosion, etc.</li> <li>▪ Ensure that the filter bed is level and remove trash and debris from the filter bed. Sand or gravel covers should be raked to a depth of 3 inches.</li> </ul>
Every 5 years	<ul style="list-style-type: none"> <li>▪ Replace top sand layer.</li> <li>▪ Till or aerate surface to improve infiltration/grass cover.</li> </ul>
As needed	<ul style="list-style-type: none"> <li>▪ Remove blockages and obstructions from inflows. Trash collected on the grates protecting the inlets shall be removed regularly to ensure the inflow capacity of the BMP is preserved.</li> <li>▪ Stabilize CDA and side-slopes to prevent erosion. Filters with a turf cover should have 95% vegetative cover.</li> </ul>
Upon failure	<ul style="list-style-type: none"> <li>▪ Corrective maintenance is required any time the sedimentation basin and sediment trap do not draw down completely after 72 hours (i.e., no standing water is allowed).</li> </ul>

**Maintenance Inspections.** Regular inspections by a qualified professional are critical to schedule sediment removal operations, replace filter media, and relieve any surface clogging. Frequent inspections are especially needed for underground and perimeter filters, since they are out of sight and can be easily forgotten. Depending on the level of traffic or the particular land use, a filter system may either become clogged within a few months of normal rainfall or could possibly last several years with only routine maintenance. Maintenance inspections should be conducted within 24 hours following a storm that exceeds 0.5 inch of rainfall, to evaluate the condition and performance of the filtering practice.

Note: Without regular maintenance, reconditioning sand filters can be very expensive.

DOEE's maintenance inspection checklists for filters and the Maintenance Service Completion Inspection form can be found in Appendix M - Maintenance Inspection Checklists.

**Declaration of Covenants.** A maintenance covenant is required for all stormwater management practices. The covenant specifies the property owner's primary maintenance responsibilities, and authorizes DOEE staff to access the property for inspection or corrective action in the event the proper maintenance is not performed. The covenant is recorded in the District of Columbia land records (see standard form, variations exist for scenarios where stormwater crosses property lines). A template form is provided at the end of Chapter 5 Administration of Stormwater Management Rules (see Figure 5.11), although variations will exist for scenarios where

stormwater crosses property lines. The covenant is between the property and the Government of the District of Columbia. It is submitted through the Office of the Attorney General. All SWMPs have a maintenance agreement stamp that must be signed for a building permit to proceed. There may be a maintenance schedule on the drawings themselves or the plans may refer to the maintenance schedule (Exhibit C in the covenant).

Covenants are not required on government properties but maintenance responsibilities must be defined through a partnership agreement or a memorandum of understanding.

**Waste Material.** Waste material from the repair, maintenance, or removal of a BMP or land cover shall be removed and disposed of in compliance with applicable federal and District law.

### 3.7.8 Filtering Volume Compliance Calculations

Filtering practices receive 0% retention value. Filtering practices are an accepted total suspended solids (TSS) treatment practice for the amount of storage volume (Sv) provided by the BMP (Table 3-29).

**Table 3-29 Filter Retention Value and Pollutant Removal**

Retention Value	= 0
Accepted TSS Treatment Practice	Yes

### 3.7.9 References

ASTM D448-12(2017), Standard Classification for Sizes of Aggregate for Road and Bridge Construction, ASTM International, West Conshohocken, PA, 2017, [www.astm.org](http://www.astm.org)

ASTM D4491 / D4491M-17, Standard Test Methods for Water Permeability of Geotextiles by Permittivity, ASTM International, West Conshohocken, PA, 2017, [www.astm.org](http://www.astm.org)

Atlanta Regional Commission (ARC). 2001. Georgia Stormwater Management Manual, First Edition. Available online at: <https://atlantaregional.org/natural-resources/water/georgia-stormwater-management-manual/>

Claytor, R. and T. Schueler. 1996. Design of Stormwater Filtering Systems. Chesapeake Research Consortium and the Center for Watershed Protection. Ellicott City, MD. <https://owl.cwp.org/>

Van Truong, Hung. 1989. The Sand Filter Water Quality Structure. D.C. Environmental Regulation Administration. Washington, DC.

Van Truong, Hung. 1993. Application of the Washington D.C. Sand Filter Water for Urban Runoff Control. Draft Report. Washington D.C. Environmental Regulations Administration. Washington, D.C. (30+ pages).

Virginia DCR Stormwater Design Specification No. 12: Filtering Practices Version 1.7. 2010.



### 3.8 Infiltration

**Definition.** Practices that capture and temporarily store the design storm volume before allowing it to infiltrate into the soil over a three-day period. Design variants include the following:

- I-1 Infiltration trench
- I-2 Infiltration basin

Infiltration practices use temporary surface or underground storage to allow incoming stormwater runoff to exfiltrate into underlying soils. Runoff first passes through multiple pretreatment mechanisms to trap sediment and organic matter before it reaches the practice. As the stormwater penetrates the underlying soil, chemical and physical adsorption processes remove pollutants. Infiltration practices are suitable for use in residential and other urban areas where field-verified saturated hydraulic conductivity is sufficient. To prevent possible groundwater contamination, infiltration practices must not be utilized at sites designated as stormwater hotspots, per Appendix Q - Stormwater Hotspots. Figure 3.33 through Figure 3.35 illustrate several infiltration design variations.

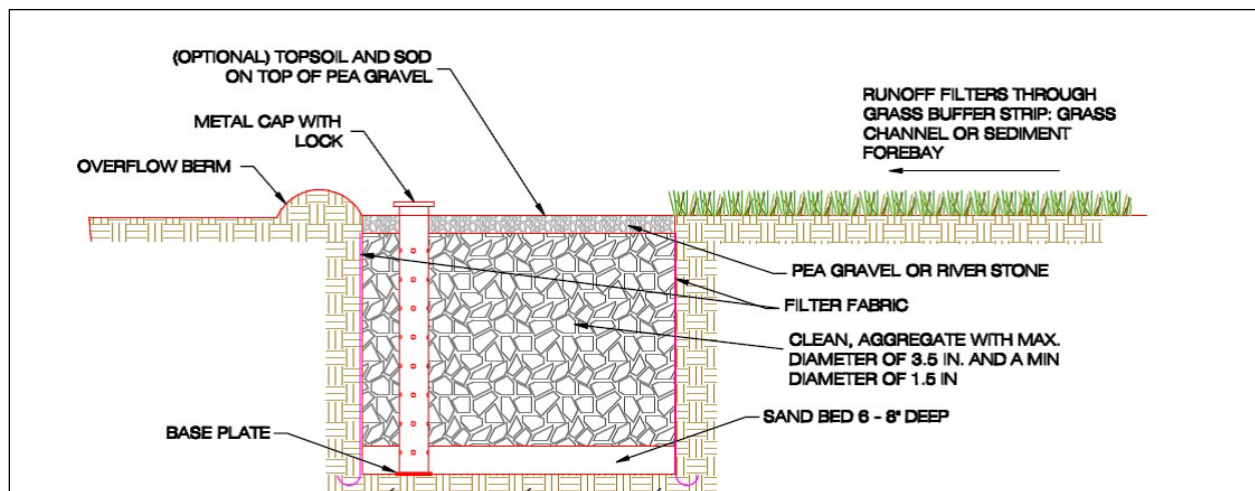
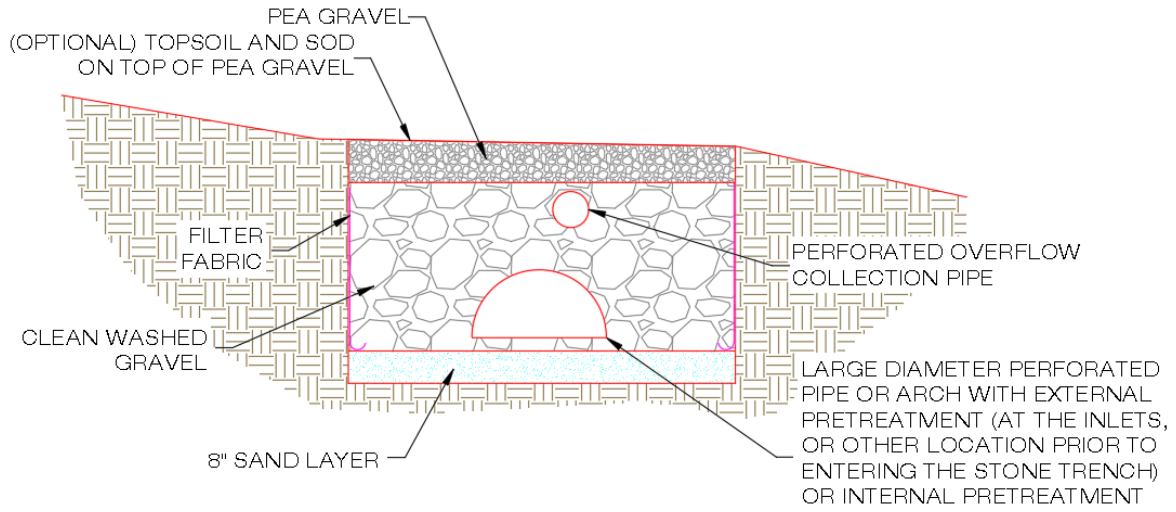


Figure 3.33 Example of an infiltration trench.



**Figure 3.34 Infiltration section with supplemental pipe storage.**

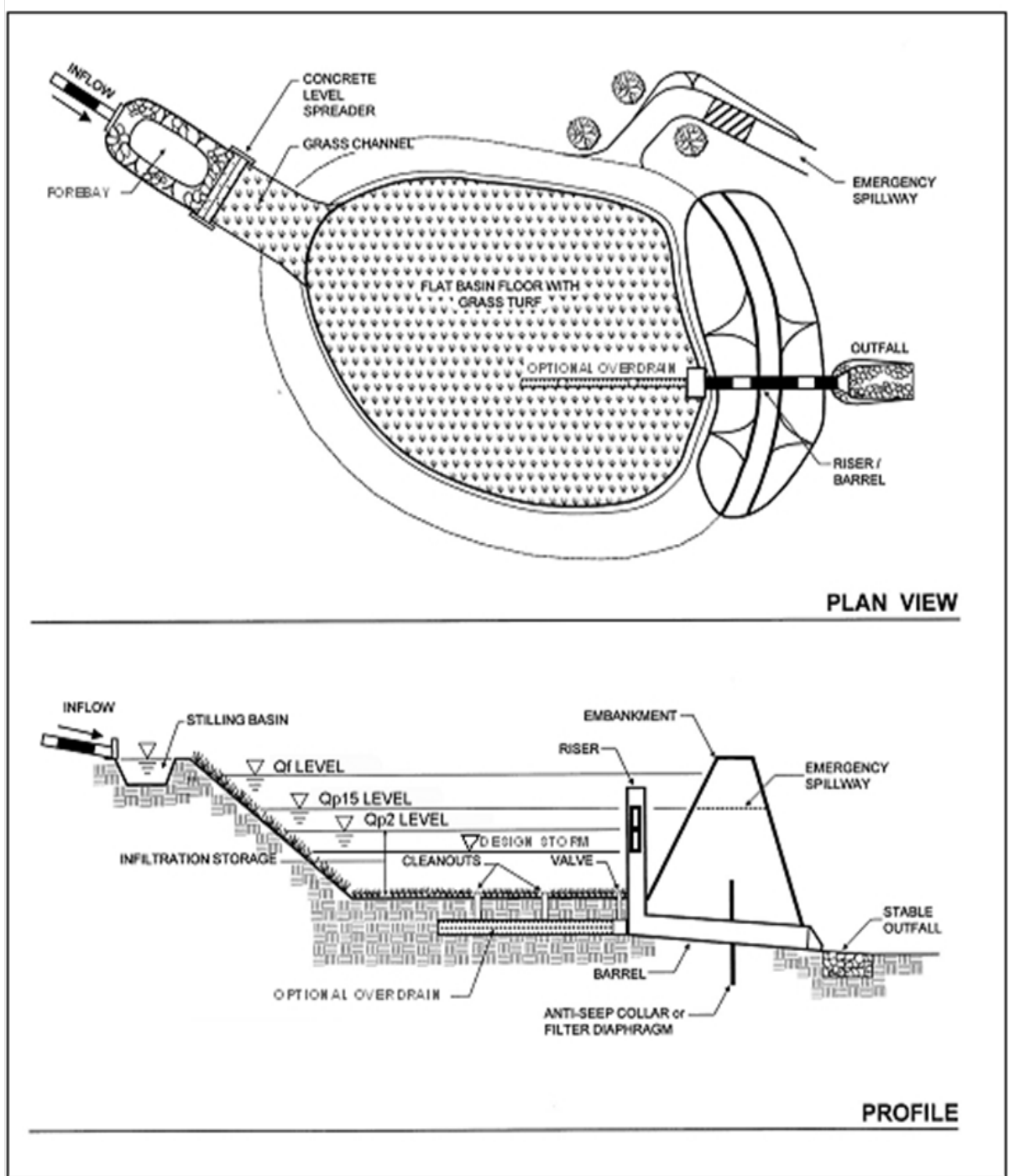


Figure 3.35 Example of an infiltration basin.

### 3.8.1 Infiltration Feasibility Criteria

Infiltration practices have very high storage and retention capabilities when sited and designed appropriately. Designers should evaluate the range of soil properties during initial site layout and seek to configure the site to conserve and protect the soils with the greatest recharge and

infiltration rates. In particular, areas of HSG A or B soils, shown on the U.S. Department of Agriculture's NRCS soil surveys, should be considered as primary locations for infiltration practices. Additional information about soil and infiltration are described in more detail later in this section. During initial design phases, designers should carefully identify and evaluate constraints on infiltration, as follows:

**Underground Injection Control for Class V Wells.** In order for an infiltration practice to avoid classification as a Class V well, which is subject to regulation under the Federal Underground Injection Control program, the practice must be wider than the practice is deep. If an infiltration practice is "deeper than its widest surface dimension" or if it includes an underground distribution system, then it will likely be considered a Class V injection well. Class V injection wells are subject to permit approval by the U.S. Environmental Protection Agency (EPA). For more information on Class V injection wells and stormwater management, designers should consult <https://www.epa.gov/uic/federal-requirements-class-v-wells> for EPA's minimum requirements.

**Contributing Drainage Area.** The maximum CDA to an individual infiltration practice should be less than 2 acres and as close to 100% impervious as possible. The design, pretreatment, and maintenance requirements will differ depending on the size of the infiltration practice.

**Site Topography.** The infiltration practice shall not be located on slopes greater than 6%, although check dams or other devices may be employed to reduce the effective slope of the practice. Further, unless slope stability calculations demonstrate otherwise, infiltration practices should be located a minimum horizontal distance of 200 feet from down-gradient slopes greater than 20%.

**Minimum Hydraulic Head.** Two or more feet of head may be needed to promote flow through infiltration practices.

**Minimum Depth to Water Table or Bedrock.** A minimum vertical distance of 2 feet must be provided between the bottom of the infiltration practice and the seasonal high water table or bedrock layer.

**Soils.** Initially, soil infiltration rates can be estimated from NRCS soil data, but designers must verify soil permeability by using the on-site soil investigation methods provided in Appendix P - Geotechnical Information Requirements for Underground BMPs

**Use on Urban Fill Soils/Redevelopment Sites.** Sites that have been previously graded or disturbed do not typically retain their original soil permeability due to compaction. Therefore, such sites are often not good candidates for infiltration practices unless the geotechnical investigation shows that a sufficient saturated hydraulic conductivity exists.

**Dry Weather Flows.** Infiltration practices should not be used on sites receiving regular dry-weather flows from sump pumps, irrigation water, chlorinated wash-water, or flows other than stormwater.

**Setbacks.** To avoid the risk of seepage, stormwater cannot flow from infiltration practices to traditional pavement base layer, existing structure foundations, or an area where there may be

future development adjacent to the property line. Setbacks to structures and property lines must be at least 10 feet and adequate waterproofing protection must be provided for foundations and basements. Where the 10-foot setback is not possible, an impermeable liner may be used along the sides of the infiltration area, extending from the surface to the bottom of the practice.

**Proximity to Utilities.** Interference with underground utilities should be avoided, if possible. When large site development is undertaken the expectation of achieving avoidance will be high. Conflicts may be commonplace on smaller sites and in the PROW. Consult with each utility company on recommended offsets, which will allow utility maintenance work with minimal disturbance to the infiltration BMP. For an infiltration BMP in the PROW, a consolidated presentation of the various utility offset recommendations can be found in Chapter 28.8.4.4 of the District of Columbia Department of Transportation Design and Engineering Manual, latest edition. Consult the District of Columbia Water and Sewer Authority (DC Water) Green Infrastructure Utility Protection Guidelines, latest edition, for water and sewer line recommendations. Where conflicts cannot be avoided, follow these guidelines:

- Consider altering the location or sizing of the infiltration BMP to avoid or minimize the utility conflict. Consider an alternate BMP type to avoid conflict.
- Use design features to mitigate the impacts of conflicts that may arise by allowing the infiltration BMP and the utility to coexist. The infiltration BMP design may need to incorporate impervious areas, through geotextiles or compaction, to protect utility crossings. Other key design features may need to be moved, added, or deleted.
- Evaluate the relocation of the existing utility and install an optimally placed and sized infiltration BMP.
- If utility functionality, longevity, and vehicular access to manholes can be assured, accept the infiltration BMP design and location with the existing utility. Incorporate into the infiltration BMP design sufficient soil coverage over the utility or general clearances or other features such as an impermeable linear to assure all entities the conflict is limited to maintenance.

Note: When accepting utility conflict into the infiltration BMP location and design, it is understood the infiltration BMP will be temporarily impacted during utility work. At the conclusion of this work, the utility owner will replace the infiltration BMP or, alternatively, install a functionally comparable infiltration BMP according to the specifications in the current version of this guidebook. If the infiltration BMP is located in the PROW, the infiltration BMP restoration will also conform with the District of Columbia Department of Transportation Design and Engineering Manual with special attention to Chapter 28 and the Design and Engineering Manual supplements for Low Impact Development and Green Infrastructure Standards and Specifications.

**Hotspots and High Loading Situations.** Infiltration practices are not intended to treat sites with high sediment or trash or debris loads, because such loads will cause the practice to clog and fail. Infiltration practices must be avoided at potential stormwater hotspots that pose a risk of groundwater contamination. For a list of potential stormwater hotspot operations, consult Appendix Q - Stormwater Hotspots.

On sites with existing contaminated soils, as indicated in Appendix P - Geotechnical Information Requirements for Underground BMPs infiltration is not allowed.

### 3.8.2 Infiltration Conveyance Criteria

The nature of the conveyance and overflow to an infiltration practice depends on the scale of infiltration and whether the facility is on-line or off-line. Where possible, conventional infiltration practices should be designed off-line to avoid damage from the erosive velocities of larger design storms. If runoff is delivered by a storm drain pipe or along the main conveyance system, the infiltration practice shall be designed as an off-line practice. Pretreatment shall be provided for storm drain pipes and conveyance systems discharging directly to infiltration systems.

**Off-line Infiltration.** Overflows can either be diverted from entering the infiltration practice or dealt with via an overflow inlet. Optional overflow methods include the following:

- Utilize a low-flow diversion or flow splitter at the inlet to allow only the design SWR<sub>v</sub> to enter the facility. This may be achieved with a weir or curb opening sized for the target flow, in combination with a bypass channel. Using a weir or curb opening helps minimize clogging and reduces the maintenance frequency (further guidance on determining the peak flow rate will be necessary in order to ensure proper design of the diversion structure).
- Use landscaping type inlets or standpipes with trash guards as overflow devices.

**On-line Infiltration.** An overflow structure must be incorporated into on-line designs to safely convey larger storms through the infiltration area. Mechanisms such as elevated drop inlets and overflow weirs are examples of how to direct high flows to a non-erosive down-slope overflow channel, stabilized water course, or storm sewer system designed to convey the 15-year design storm.

### 3.8.3 Infiltration Pretreatment Criteria

Every infiltration system shall have pretreatment mechanisms to protect the long-term integrity of the infiltration rate. One of the following techniques must be installed to pretreat 100% of the inflow in every facility:

- Grass channel
- Grass filter strip (sheet flow must be maintained over a length of 20 feet)
- Forebay or sump pit (must accommodate a minimum of 15% of the design storm volume)
- Gravel diaphragm (minimum 1 foot deep and 2 feet wide and only if sheet flow is established and maintained)
- Filter system (see Section 3.7 Filtering Systems) If using a filter system as a pretreatment facility, the sand filter will not require its own separate pretreatment facility.
- A proprietary structure with demonstrated capability of reducing sediment and hydrocarbons may be used to provide pretreatment. Refer to Section 3.13 Proprietary Practices and

---

Appendix T - Proprietary Practices Approval Process for information on approved proprietary structures.

If the basin serves a CDA greater than 20,000 square feet, a forebay, sump pit, filter system, or proprietary practice must be used for pretreatment.

Exit velocities from the pretreatment chamber shall not be erosive (above 6 fps) during the 15-year design storm and flow from the pretreatment chamber should be evenly distributed across the width of the practice (e.g., using a level spreader).

### 3.8.4 Infiltration Design Criteria

**Geometry.** Where possible, an infiltration practice should be designed to be wider than it is deep, to avoid classification as a Class V injection well. For more information on Class V wells see <https://www.epa.gov/uic/class-v-wells-injection-non-hazardous-fluids-or-above-underground-sources-drinking-water>

**Practice Slope.** The bottom of an infiltration practice should be flat (i.e., 0% longitudinal and lateral slopes) to enable even distribution and infiltration of stormwater.

**Infiltration Basin Geometry.** The maximum vertical depth to which runoff may be ponded over an infiltration basin is 24 inches. The side-slopes should be no steeper than 4H:1V.

**Surface Cover (optional).** Designers may choose to install a layer of topsoil and grass above the infiltration practice.

**Surface Stone.** A 3-inch layer of river stone or No. 8 or 89 stone should be installed over the stone layer. Stone must be washed clean and free of fines (no more than 2% passing the No. 200 sieve).

**Stone Layer.** Stone layers must consist of aggregate with a maximum diameter of 3.5 inches and a minimum diameter of 1.5 inches. Aggregate must be washed clean and free of fines.

**Observation Wells.** All infiltration practices must include at least one observation well. The observation well is used to observe the rate of drawdown within the infiltration practice following a storm event and to facilitate periodic inspection and maintenance. The observation well should consist of a well-anchored, perforated 4- to 6-inch diameter PVC pipe. There should be no perforation within 1 foot of the surface. The observation well should extend vertically to the bottom of the stone layer and extend upward to the top of ponding.

**Underground Storage (optional).** In the underground mode, runoff is stored in the voids of the stones and infiltrates into the underlying soil matrix. Perforated corrugated metal pipe, plastic pipe, concrete arch pipe, or comparable materials can be used in conjunction with the stone to increase the available temporary underground storage. In some instances, a combination of filtration and infiltration cells can be installed in the floor of a dry extended detention (ED) pond.

**Overflow Collection Pipe (Overdrain).** An optional overflow collection pipe can be installed in the stone layer to convey collected runoff from larger storm events to a downstream conveyance system.

**Trench Bottom.** To protect the bottom of an infiltration trench from intrusion by underlying soils, a sand layer must be used. The underlying native soils must be separated from the stone layer by a 6- to 8-inch layer of coarse sand (e.g., ASTM C-33, 0.02–0.04 inch in diameter).

**Geotextile Fabric.** An appropriate geotextile fabric that complies with AASHTO M-288 Class 2, latest edition, requirements and has a permeability of at least an order of magnitude (10 times) higher than the soil subgrade permeability must be used. This layer should be applied only to the sides of the practice.

**Material Specifications.** Recommended material specifications for infiltration areas are shown in Table 3.30.

**Table 3.30 Infiltration Material Specifications**

Material	Specification	Notes
Surface Layer (optional)	Topsoil and grass layer	
Surface Stone	Install a 3-inch layer of river stone or pea gravel.	Provides an attractive surface cover that can suppress weed growth.
Stone Layer	Aggregate with a maximum diameter of 3.5 inches and a minimum diameter of 1.5 inches. Stone must be washed clean and free of fines (no more than 2% passing the No. 200 sieve).	
Observation Well	Install a vertical 6-inch Schedule 40 PVC perforated pipe, with a lockable cap and anchor plate.	Install one per 50 feet of length of infiltration practice.
Overflow Collection Pipe (optional)	Use 4- or 6-inch rigid schedule 40 PVC pipe, with three or four rows of 3/8-inch perforations at 6 inches on center.	
Trench Bottom	Install a 6- to 8-inch sand layer (e.g., ASTM C-33, 0.02–0.04 inch in diameter)	
Geotextile Fabric (sides only)	An appropriate geotextile fabric that complies with AASHTO M-288 Class 2, latest edition, requirements and has a permeability of at least an order of magnitude (10 times) higher than the soil subgrade permeability must be used.	

**Practice Sizing.** The proper approach for designing infiltration practices is to avoid forcing a large amount of infiltration into a small area. Therefore, individual infiltration practices that are limited in size due to soil permeability and available space need not be sized to achieve the full design storm volume (SWR<sub>v</sub>) for the CDA, as long as other stormwater treatment practices are applied at the site to meet the remainder of the design storm volume.

Several equations are needed to size infiltration practices. The first equations establish the maximum depth of the infiltration practice, depending on whether it is a surface basin (Equation 3.11) or trench with an underground reservoir (Equation 3.12).

### Equation 3.11 Maximum Surface Basin Depth for Infiltration Basins



$$d_{max} = K_{sat} \times t_d$$

**Equation 3.12 Maximum Underground Reservoir Depth for Infiltration Trenches**

$$d_{max} = \frac{(K_{sat} \times t_d)}{\eta_r}$$

where:

- $d_{max}$  = maximum depth of the infiltration practice (ft)
- $K_{sat}$  = field-verified saturated hydraulic conductivity for the native soils (ft/day)
- $t_d$  = maximum drawdown time (day) (normally 3 days)
- $\eta_r$  = available porosity of the stone reservoir (assume 0.4)

Note: These equations make the following design assumptions:

- **Stone Layer Porosity.** A porosity value of 0.4 shall be used in the design of stone reservoirs, although a larger value for porosity may be used if perforated corrugated metal pipe, plastic pipe, concrete arch pipe, or comparable materials are installed within the reservoir. For surface basins, when no reservoir is used, the porosity value is 1.
- **Rapid Drawdown.** Infiltration practices must be sized so that the design volume infiltrates within 72 hours, to prevent nuisance ponding conditions.

Once the maximum depth is known, calculate the surface area needed for an infiltration practice using Equation 3.13 or Equation 3.14.

**Equation 3.13 Surface Basin Surface Area for Infiltration Basins**

$$SA = \frac{DesignStorm}{d + (K_{sat} \times t_f)}$$

**Equation 3.14 Underground Reservoir Surface Area for Infiltration Trenches**

$$SA = \frac{DesignStorm}{(\eta_r \times d) + (K_{sat} \times t_f)}$$

where:

$SA$	=	surface area (ft <sup>2</sup> )
$DesignStorm$	=	SWRv or other design storm volume (ft <sup>3</sup> ) (e.g., portion of the SWRv)
$\eta_r$	=	available porosity of the stone reservoir (assume 0.4)
$d$	=	infiltration depth (ft) (maximum depends on the the results of Equation 3.11 or 3.12)
$K_{sat}$	=	field-verified saturated hydraulic conductivity for the native soils (ft/day)
$t_f$	=	time to fill the infiltration facility (days) (typically 2 hours, or 0.083 days)

The storage volume ( $S_v$ ) captured by the infiltration practice is defined as the volume of water that is fully infiltrated through the practice (i.e., no overflow). Designers may choose to infiltrate less than the full design storm (SWRv). In this case, the design volume captured must be treated as the  $S_v$  of the practice (see Section 3.8.8 Infiltration Stormwater Compliance Calculations).  $S_v$  can be determined by rearranging Equation 3.13 and Equation 3.14 to yield Equation 3.15 and Equation 3.16.

**Equation 3.15 Storage Volume Calculation for Surface Basin Area for Infiltration Basins**

$$S_v = SA \times [d + (K_{sat} \times t_f)]$$

**Equation 3.16 Storage Volume Calculation for Underground Reservoir Surface Area for Infiltration Trenches**

$$S_v = SA \times [(\eta_r \times d) + (K_{sat} \times t_f)]$$

Infiltration practices can also be designed to address, in whole or in part, the detention storage needed to comply with channel protection and/or flood control requirements. The designer can model various approaches by factoring in storage within the stone aggregate layer, any perforated corrugated metal pipe, plastic pipe, concrete arch pipe, or comparable materials installed within the reservoir, expected infiltration, and any outlet structures used as part of the design. Routing calculations can also be used to provide a more accurate solution of the peak discharge and required storage volume.

**3.8.5 Infiltration Landscaping Criteria**

Infiltration trenches can be effectively integrated into the site plan and aesthetically designed with adjacent native landscaping or turf cover, subject to the following additional design considerations:

- Infiltration practices should not be installed until all up-gradient construction is completed and pervious areas are stabilized with dense and healthy vegetation, unless the practice can be kept off-line so it receives no runoff until construction and stabilization is complete.
- Vegetation associated with the infiltration practice buffers should be regularly maintained to limit organic matter in the infiltration device and maintain enough vegetation to prevent soil erosion from occurring.

### 3.8.6 Infiltration Construction Sequence

Infiltration practices are particularly vulnerable to failure during the construction phase for two reasons. First, if the construction sequence is not followed correctly, construction sediment can clog the practice. Second, loading from heavy construction equipment can result in compaction of the soil, which can then reduce the soil's infiltration rate. For this reason, a careful construction sequence needs to be followed.

During site construction, the following protective measures are absolutely critical:

- All areas proposed for infiltration practices should be fully protected from sediment intrusion by silt fence or construction fencing, particularly if they are intended to infiltrate runoff.
- Avoid excessive compaction by preventing construction equipment and vehicles from traveling over the proposed location of the infiltration practice. To accomplish this, areas intended to infiltrate runoff must remain outside the limits of disturbance during construction.
- When this is unavoidable, there are several possible remedies for the impacted area.
  - ◆ If excavation at the impacted area can be restricted, then remediation can be achieved with deep tilling practices. This is only possible if in situ soils are not disturbed below 2 feet above the final design elevation of the bottom of the infiltration practice. In this case, when heavy equipment activity has ceased, the area is excavated to grade, and the impacted area must be tilled a minimum of 12 inches below the bottom of the infiltration practice.
  - ◆ Alternatively, if it is infeasible to keep the proposed infiltration practice outside of the limits of disturbance, and excavation of the area cannot be restricted, then infiltration tests will be required prior to installation of the infiltration practice to ensure that the design infiltration rate is still present. If tests reveal the loss of design infiltration rates, then deep tilling practices may be used in an effort to restore those rates. In this case further testing must be done to establish design rates exist before the infiltration practice can be installed.
  - ◆ Finally, if it is infeasible to keep the proposed permeable pavement areas outside of the limits of disturbance, excavation of the area cannot be restricted, and infiltration tests reveal design rates cannot be restored, then a resubmission of the SWMP will be required.
- Any area of the site intended ultimately to be an infiltration practice should not be used as the site of a temporary sediment trap or basin. If locating a sediment trap or basin on an area intended for infiltration is unavoidable, the remedies are similar to those discussed for heavy

equipment compaction. If possible, restrict the invert of the sediment trap or basin to at least 2 feet above the final design elevation of the bottom of the proposed infiltration practice. Then remediation can be achieved with proper removal of trapped sediments and deep tilling practices. An alternate approach to deep tilling is to use an impermeable liner to protect the in situ soils from sedimentation while the sediment trap or basin is in use. In each case, all sediment deposits must be carefully removed prior to installing the infiltration practice.

- Keep the infiltration practice off-line until construction is complete. Prevent sediment from entering the infiltration site by using silt fence, diversion berms, or other means. In the soil erosion and sediment control plan, indicate the earliest time at which stormwater runoff may be directed to a conventional infiltration basin. The soil erosion and sediment control plan must also indicate the specific methods to be used to temporarily keep runoff from the infiltration site.
- Upland CDAs need to be completely stabilized with a well-established layer of vegetation prior to commencing excavation for an infiltration practice.

**Infiltration Installation.** The actual installation of an infiltration practice is done using the following steps:

**Step 1: Avoid Impact of Heavy Installation Equipment.** Excavate the infiltration practice to the design dimensions from the side using a backhoe or excavator. The floor of the pit should be completely level, but equipment should be kept off the floor area to prevent soil compaction.

**Step 2: Hang Geotextile Walls.** Install geotextile fabric on the trench sides. Large tree roots should be trimmed flush with the sides of infiltration trenches to prevent puncturing or tearing of the geotextile fabric during subsequent installation procedures. When laying out the geotextile, the width should include sufficient material to compensate for perimeter irregularities in the trench and for a 6-inch minimum overlap at the top of the trench. The geotextile fabric itself should be tucked under the sand layer on the bottom of the infiltration trench. Stones or other anchoring objects should be placed on the fabric at the trench sides, to keep the trench open during windy periods. Voids may occur between the fabric and the excavated sides of a trench. Natural soils should be placed in all voids, to ensure the fabric conforms smoothly to the sides of excavation.

**Step 3: Promote Infiltration Rate.** Scarify the bottom of the infiltration practice, and spread 6 inches of sand on the bottom as a filter layer.

**Step 4: Observation Wells.** Anchor the observation well(s) and add stone to the practice in 1-foot lifts.

**Step 5: Stabilize Surrounding Area.** Use sod, where applicable, to establish a dense turf cover for at least 10 feet around the sides of the infiltration practice, to reduce erosion and sloughing.

**Construction Supervision.** Supervision during construction is recommended to ensure that the infiltration practice is built in accordance with the approved design and this specification. Qualified individuals should use detailed inspection checklists to include sign-offs at critical stages of construction, to ensure that the contractor's interpretation of the plan is consistent with the designer's intentions.

DOEE's construction phase inspection checklist for infiltration practices can be found in Appendix L - Construction Inspection Checklists

### 3.8.7 Infiltration Maintenance Criteria

Maintenance is a crucial and required element that ensures the long-term performance of infiltration practices. The most frequently cited maintenance problem for infiltration practices is clogging of the stone layer by organic matter and sediment. The following design features can minimize the risk of clogging:

**Stabilized CDA.** Infiltration systems may not receive runoff until the entire CDA has been completely stabilized.

**Observation Well.** Infiltration practices must include an observation well to facilitate periodic inspection and maintenance. Design criteria must include an anchored 6-inch diameter perforated PVC pipe fitted with a lockable cap installed flush with the ground surface.

**No Geotextile Fabric on Bottom.** Avoid installing geotextile fabric along the bottom of infiltration practices. Experience has shown that geotextile fabric is prone to clogging. However, permeable geotextile fabric should be installed on the trench sides to prevent soil piping.

**Direct Maintenance Access.** Access must be provided to allow personnel and heavy equipment to perform atypical maintenance tasks, such as practice reconstruction or rehabilitation. While a turf cover is permissible for small-scale infiltration practices, the surface must never be covered by an impermeable material, such as asphalt or concrete.

**Maintenance Inspections.** Effective long-term operation of infiltration practices requires a dedicated and routine maintenance inspection schedule with clear guidelines and schedules, as shown in Table 3-30. Where possible, facility maintenance should be integrated into routine landscaping maintenance tasks.

**Table 3-30 Typical Maintenance Activities for Infiltration Practices**

Schedule	Maintenance Activity
Quarterly	<ul style="list-style-type: none"> <li>▪ Ensure that the CDA, inlets, and facility surface are clear of debris.</li> <li>▪ Ensure that the CDA is stabilized. Perform spot-reseeding if where needed.</li> <li>▪ Remove sediment and oil/grease from inlets, pretreatment devices, flow diversion structures, and overflow structures.</li> <li>▪ Repair undercut and eroded areas at inflow and outflow structures.</li> </ul>
Semi-annual inspection	<ul style="list-style-type: none"> <li>▪ Check observation wells 3 days after a storm event in excess of 0.5 inch in depth. Standing water observed in the well after 3 days is a clear indication of clogging.</li> <li>▪ Inspect pretreatment devices and diversion structures for sediment build-up and structural damage.</li> </ul>
Annually	<ul style="list-style-type: none"> <li>▪ Clean out accumulated sediment from the pretreatment cell.</li> </ul>
As needed	<ul style="list-style-type: none"> <li>▪ Replace pea gravel/topsoil and top surface geotextile fabric (when clogged).</li> <li>▪ Mow vegetated filter strips as necessary and remove the clippings.</li> </ul>

It is highly recommended that a qualified professional conduct annual site inspections for infiltration practices to ensure the practice performance and longevity of infiltration practices.

DOEE’s maintenance inspection checklist for infiltration systems and the Maintenance Service Completion Inspection form can be found in Appendix M - Maintenance Inspection Checklists.

**Declaration of Covenants.** A declaration of covenants that includes all maintenance responsibilities to ensure the continued stormwater performance for the BMP is required. The declaration of covenants specifies the property owner’s primary maintenance responsibilities, and authorizes DOEE staff to access the property for inspection or corrective action in the event the proper maintenance is not performed. The declaration of covenants is recorded in the District of Columbia land records. A template form is provided at the end of Chapter 5 Administration of Stormwater Management Rules (see Figure 5.11), although variations will exist for scenarios where stormwater crosses property lines. The covenant is between the property and the Government of the District of Columbia. It is submitted through the Office of the Attorney General. All SWMPs have a maintenance agreement stamp that must be signed for a building permit to proceed. A maintenance schedule must appear on the SWMP. Additionally, a maintenance schedule is required in Exhibit C of the declaration of covenants.

Covenants are not required on government properties, but maintenance responsibilities must be defined through a partnership agreement or a memorandum of understanding.

**Waste Material.** Waste material from the repair, maintenance, or removal of a BMP or land cover shall be removed and disposed of in compliance with applicable federal and District of Columbia law.

### 3.8.8 Infiltration Stormwater Compliance Calculations

Infiltration practices receive 100% retention value for the amount of storage volume ( $S_v$ ) provided by the practice (Table 3-31) and is considered an accepted total suspended solids (TSS) treatment practice.

**Table 3-31 Infiltration Retention Value and Pollutant Removal**

Retention Value	= $S_v$
Accepted TSS Treatment Practice	Yes

The practice must be sized using the guidance detailed in Section 3.8.4, “Infiltration Design Criteria.”

Infiltration practices also contribute to peak flow reduction. This contribution can be determined in several ways. One method is to subtract the storage volume ( $S_v$ ) from the total runoff volume for the 2-year, 15-year, and 100-year storms. The resulting reduced runoff volumes can then be used to calculate a reduced NRCS CN for the site or SDA. The reduced NRCS CN can then be used to calculate peak flow rates for the various storm events. Other hydrologic modeling tools that employ different procedures may be used as well.

### **3.8.9 References**

Virginia DCR Stormwater Design Specification No. 8: Bioretention Version 1.8. 2010.

### 3.9 Open Channel Systems

**Definition.** Vegetated open channels that are designed to capture and treat or convey the design storm volume (SWR<sub>v</sub>). Design variants include the following:

- O-1 Grass channels
- O-2 Dry swales/bioswales
- O-3 Wet swales

Open channel systems shall not be designed to provide stormwater detention except under extremely unusual conditions. Open channel systems must generally be combined with a separate facility to meet these requirements.

**Grass channels (O-1)** can provide a modest amount of runoff filtering and volume attenuation within the stormwater conveyance system resulting in the delivery of less runoff and pollutants than a traditional system of curb and gutter, storm drain inlets, and pipes (see Figure 3.36). The performance of grass channels will vary depending on the underlying soil permeability. Grass channels, however, are not capable of providing the same stormwater functions as dry swales as they lack the storage volume associated with the engineered filter media. Their retention performance can be boosted when compost amendments are added to the bottom of the swale (see Appendix K - Soil Compost Amendment Requirements). Grass channels are a preferable alternative to both curb and gutter and storm drains as a stormwater conveyance system, where development density, topography, and soils permit.

**Dry swales (O-2)**, also known as bioswales, are essentially bioretention cells that are shallower, configured as linear channels, and covered with turf or other surface material (other than mulch and ornamental plants; see Figure 3.37). The dry swale is a soil filter system that temporarily stores and then filters the desired design storm volume. Dry swales rely on a premixed filter media below the channel that is identical to that used for bioretention. In most cases, the runoff treated by the filter media flows into an underdrain, which conveys treated runoff back to the conveyance system further downstream. The underdrain system consists of a perforated pipe within a gravel layer on the bottom of the swale, beneath the filter media. However, if soils are permeable, runoff infiltrates into underlying soils and the dry swale can be designed without an underdrain as if it were an enhanced bioretention. In either case, check dams should be constructed to encourage ponding (see Site Topography). Dry swales may appear as simple grass channels with the same shape and turf cover, while others may have more elaborate landscaping. Swales can be planted with turf grass, tall meadow grasses, decorative herbaceous cover, or trees.

**Wet swales (O-3)** can provide a modest amount of runoff filtering within the conveyance (see Figure 3.38). These linear wetland cells often intercept shallow groundwater to maintain a wetland plant community. The saturated soil and wetland vegetation provide an ideal environment for gravitational settling, biological uptake, and microbial activity. On-line or off-line cells are formed within the channel to create saturated soil or shallow standing water conditions (typically less than 6 inches deep).



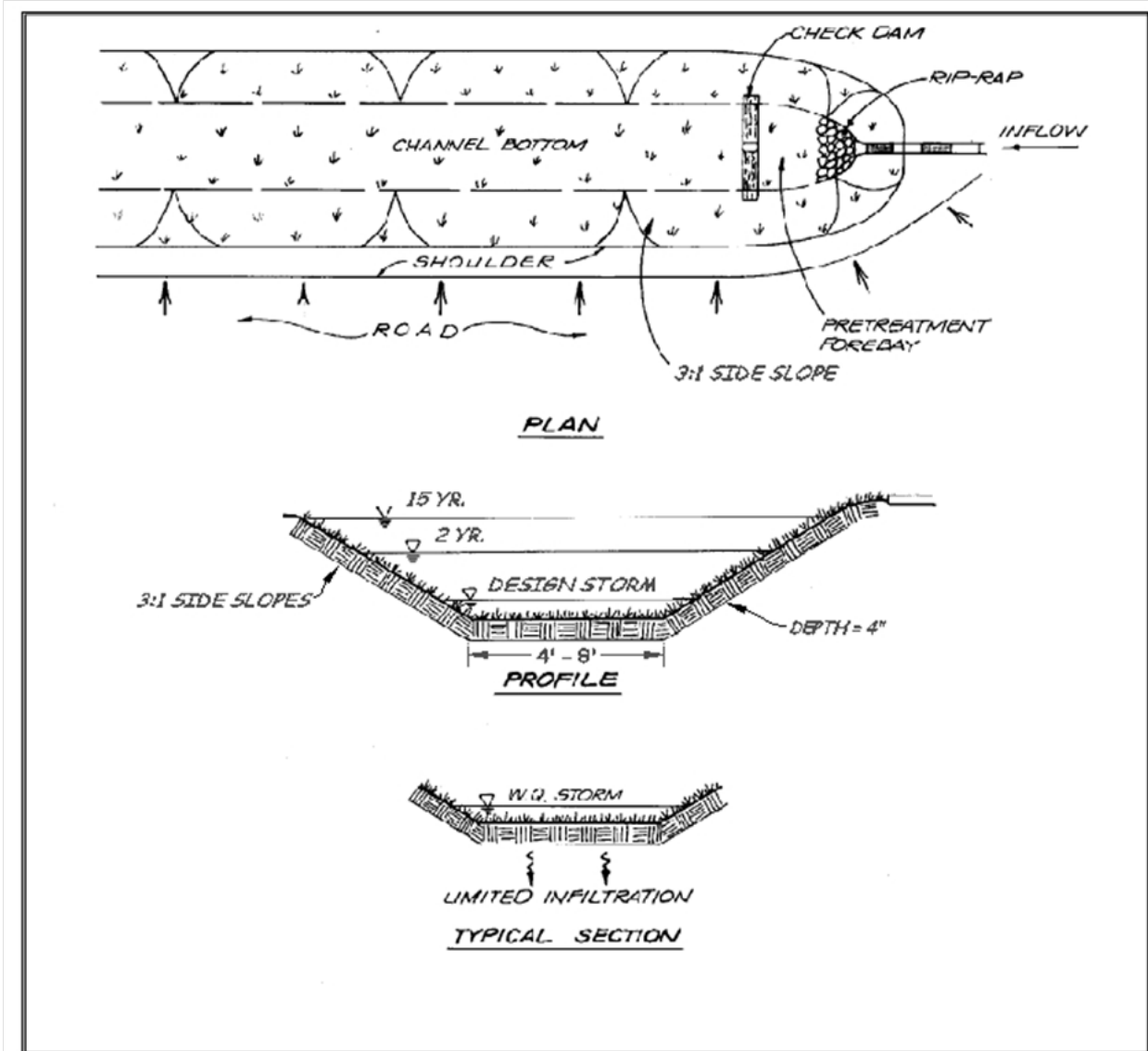


Figure 3.36 Grass channel typical plan, profile, and section views (O-1).

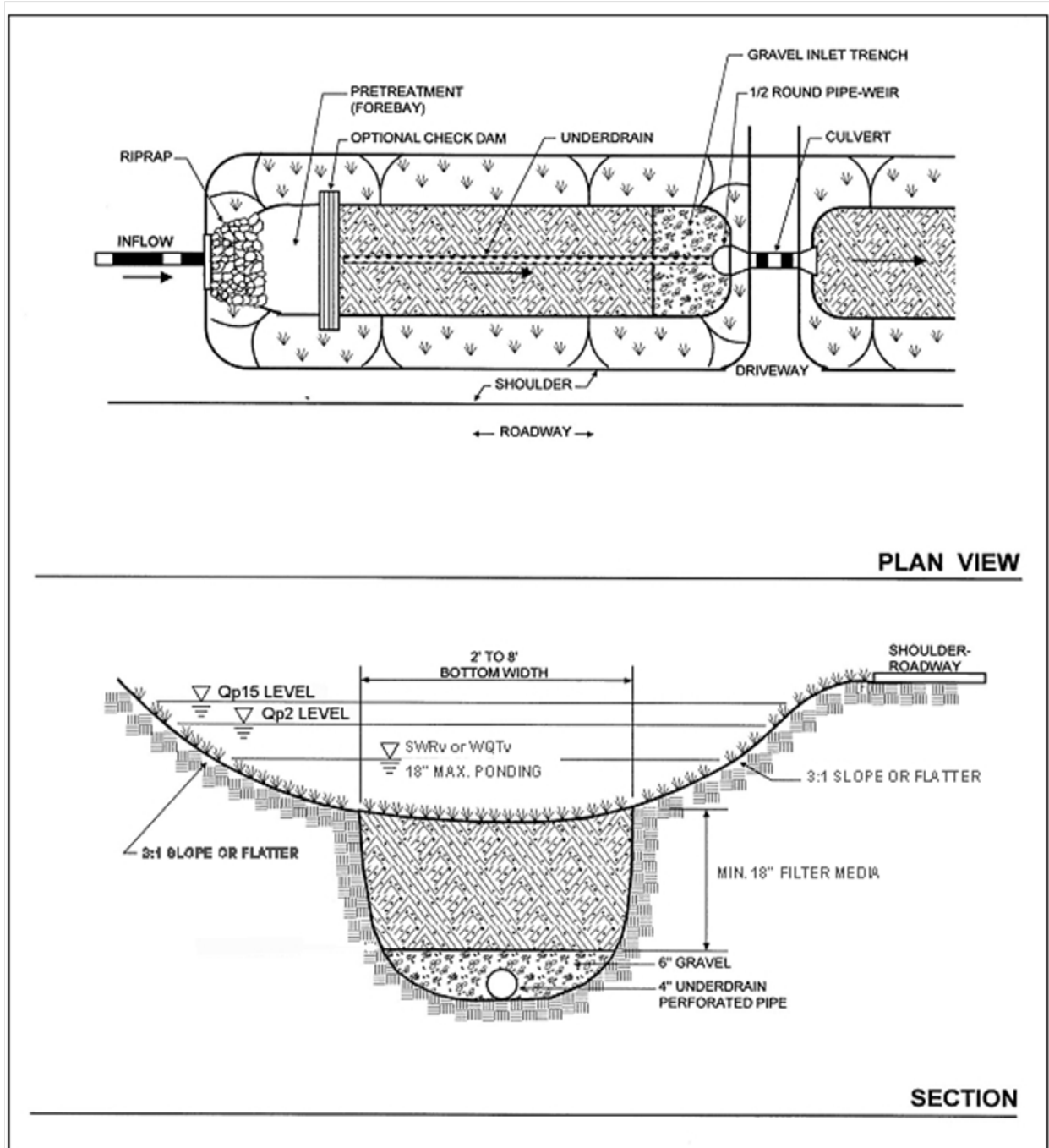


Figure 3.37 Example of a dry swale (O-2).

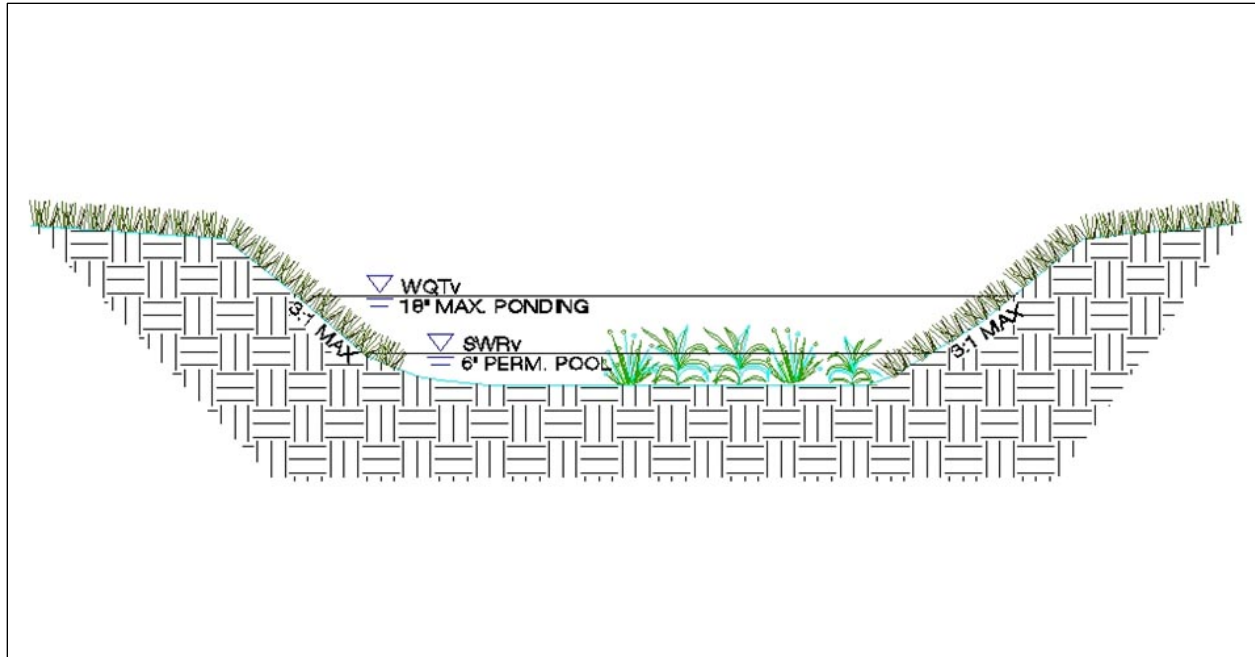


Figure 3.38 Example of a wet swale (O-3).

### 3.9.1 Open Channel Feasibility Criteria

Open channel systems are primarily applicable for land uses, such as roads, highways, and residential development. Some key feasibility issues for open channels include the following:

**Contributing Drainage Area.** The maximum CDA to an open channel should be 2.5 acres, preferably less. When open channels treat and convey runoff from CDAs greater than 2.5 acres, the velocity and flow depth through the channel often becomes too great to treat runoff or prevent erosion in the channel. The design criteria for maximum channel velocity and depth are applied along the entire length (see Section 3.9.4 Open Channel Design Criteria). Dry Swales should be approximately 3%–10% of the size of the CDA, depending on the amount of impervious cover. Wet swale footprints usually cover about 5%–15% of their CDA.

**Available Space.** Open channel footprints can fit into relatively narrow corridors between utilities, roads, parking areas, or other site constraints. Grass channels can be incorporated into linear development applications (e.g., roadways) by utilizing the footprint typically required for an open section drainage feature. The footprint required will likely be greater than that of a typical conveyance channel. However, the benefit of the retention may reduce the footprint requirements for stormwater management elsewhere on the development site.

**Site Topography.** Grass channels and wet swales should be used on sites with longitudinal slopes of less than 4%. Check dams can be used to reduce the effective slope of the channel and lengthen the contact time to enhance filtering and/or infiltration. Longitudinal slopes of less than 2% are ideal and may eliminate the need for check dams. However, channels designed with

longitudinal slopes of less than 1% should be monitored carefully during construction to ensure a continuous grade, in order to avoid flat areas with pockets of standing water.

For dry swales, check dams will be necessary regardless of the longitudinal slope to create the necessary ponding volume. Check dams must be constructed of a solid material that will allow ponding.

**Land Uses.** Open channels can be used in residential, commercial, or institutional development settings.

When open channels are used for both conveyance and water quality treatment, they should be applied only in linear configurations parallel to the contributing impervious cover, such as roads and small parking areas. The linear nature of open channels makes them well-suited to treat highway or low- and medium-density residential road runoff, if there is adequate right-of-way width and distance between driveways. Typical applications of open channels include the following, as long as CDA limitations and design criteria can be met:

- Within a roadway or bicycle path right-of-way;
- Along the margins of small parking lots;
- Oriented from the roof (downspout discharge) to the street;
- Disconnecting small impervious areas; and
- Used to treat the managed turf areas of parkland, sports fields, golf courses, and other turf-intensive land uses, or to treat CDAs with both impervious and managed turf cover (such as residential streets and yards).

Open channels are not recommended when residential density exceeds more than 4 dwelling units per acre, due to a lack of available land and the frequency of driveway crossings along the channel.

Open channels can also provide pretreatment for other stormwater treatment practices.

**Available Hydraulic Head.** A minimum amount of hydraulic head is needed to implement open channels in order to ensure positive drainage and conveyance through the channel. The hydraulic head for wet swales and grass channels is measured as the elevation difference between the channel inflow and outflow point. The hydraulic head for dry swales is measured as the elevation difference between the inflow point and the storm drain invert (unless an infiltration-based design will be used). Dry swales typically require 3 to 5 feet of hydraulic head since they have both a filter bed and underdrain.

**Hydraulic Capacity.** Open channels are typically designed as on-line practices that must be designed with enough capacity to (1) convey runoff from the 2-year and 15-year design storms at non-erosive velocities, and (2) contain the 15-year flow within the banks of the swale. This means that the swale's surface dimensions are more often determined by the need to pass the 15-year storm events, which can be a constraint in the siting of open channels within existing rights-of-way (e.g., constrained by sidewalks).

**Depth to Water Table.** The bottom of dry swales and grass channels must be at least 2 feet above the groundwater table, to ensure that groundwater does not intersect the filter bed, since this could lead to groundwater contamination or practice failure. It is permissible for wet swales to intersect the water table.

**Soils.** Soil conditions do not constrain the use of open channels, although they do dictate some design considerations:

- Dry swales in soils with low infiltration rates may need an underdrain. Designers must verify site-specific soil permeability at the proposed location using the methods for on-site soil investigation presented in Appendix P - Geotechnical Information Requirements for Underground BMPs, in order to eliminate the requirements for a dry swale underdrain.
- Grass channels situated on low-permeability soils may incorporate compost amendments in order to improve performance (see Appendix K - Soil Compost Amendment Requirements).
- Wet swales work best on the more impermeable HSG C or D soils.
- At infill soil locations, geotechnical investigations are required to determine if the use of an impermeable liner and underdrain are necessary for open channel designs.

**Utilities.** Typically, utilities can cross linear channels if they are specially protected (e.g., double-casing). Interference with underground utilities should be avoided, if possible. When large site development is undertaken, the expectation of achieving avoidance will be high. Conflicts may be commonplace on smaller sites and in the PROW. Where conflicts cannot be avoided, these guidelines shall be followed:

- Consult with each utility company on recommended offsets that will allow utility maintenance work with minimal disturbance to the BMP.
- Whenever possible, coordinate with utility companies to allow them to replace or relocate their aging infrastructure while BMPs are being implemented.
- BMP and utility conflicts will be a common occurrence in PROW projects. However, the standard solution to utility conflict should be the acceptance of conflict provided sufficient soil coverage over the utility can be assured.
- Additionally, when accepting utility conflict into the BMP design, it is understood that the BMP will be temporarily impacted during utility maintenance but restored to its original condition.

**Avoidance of Irrigation or Baseflow.** Open channels should be located so as to avoid inputs of springs, irrigation systems, chlorinated wash-water, or other dry weather flows.

**Setbacks.** To avoid the risk of seepage, stormwater cannot flow from the open channel reservoir layer or via baseflow to the traditional pavement base layer, existing structure foundations, or an area where there may be future development adjacent to the property line. Setbacks to structures and property lines must be at least 10 feet and adequate waterproofing protection must be provided for foundations and basements. Where the 10-foot setback is not possible, an impermeable liner may be used along the sides of the open channel extending from the surface to the bottom of the practice.

**Hotspot Land Use.** Runoff from hotspot land uses must not be treated with infiltrating dry swales due to the potential interaction with the water table and the risk that hydrocarbons, trace metals, and other toxic pollutants could migrate into the groundwater. An impermeable liner must be used for filtration of hotspot runoff for dry swales. Grass channels can typically be used to convey runoff from stormwater hotspots, but they do not qualify as a hotspot treatment mechanism. Wet swales are not recommended to treat stormwater hotspots, due to the potential interaction with the water table and the risk that hydrocarbons, trace metals, and other toxic pollutants could migrate into the groundwater. For a list of designated stormwater hotspot operations, consult Appendix Q - Stormwater Hotspots.

On sites with existing contaminated soils, as indicated in Appendix Q - Stormwater Hotspots, infiltration is not allowed. Dry and wet swales must include an impermeable liner.

### 3.9.2 Open Channel Conveyance Criteria

The bottom width and slope of a grass channel must be designed such that the velocity of flow from the design storm provides a minimum hydraulic residence time (average travel time for a particle of water through a waterbody) of 9 minutes for the peak flows from the SWRv or design storm. Check dams may be used to achieve the needed retention volume, as well as to reduce the flow velocity. Check dams must be spaced based on channel slope and ponding requirements, consistent with the criteria in Section 3.9.4, “Open Channel Design Criteria.”

Open channels must also convey the 2- and 15-year storms at non-erosive velocities (generally less than 6 feet per second) for the soil and vegetative cover provided. The final designed channel shall provide 6 inches minimum freeboard above the designated water surface profile of the channel. The analysis must evaluate the flow profile through the channel at normal depth, as well as the flow depth over top of the check dams.

### 3.9.3 Open Channel Pretreatment Criteria

Pretreatment is required for open channels to dissipate energy, trap sediments, and slow down the runoff velocity.

The selection of a pretreatment method depends on whether the channel will experience sheet flow or concentrated flow. Several options are as follows:

- **Check Dams (channel flow).** These energy dissipation devices are acceptable as pretreatment on small open channels with CDAs of less than 1 acre. The most common form is the use of wooden or stone check dams. The pretreatment volume stored must be 15% of the design volume.
- **Tree Check Dams (channel flow).** These are street tree mounds that are placed within the bottom of grass channels up to an elevation of 9 to 12 inches above the channel invert. One side has a gravel or river stone bypass to allow runoff to percolate through (Cappiella et al, 2006). The pretreatment volume stored must be 15% of the design volume.
- **Grass Filter Strip (sheet flow).** Grass filter strips extend from the edge of the pavement to the bottom of the open channel at a slope of 5H:1V or flatter. Alternatively, provide a

combined 5 feet of grass filter strip at a maximum 5% (20H:1V) cross slope and 3H:1V or flatter side slopes on the open channel.

- **Gravel or Stone Diaphragm (sheet flow).** The gravel diaphragm is located at the edge of the pavement or the edge of the roadway shoulder and extends the length of the channel to pretreat lateral runoff. This requires a 2- to 4-inch elevation drop from a hard-edged surface into a gravel or stone diaphragm. The stone must be sized according to the expected rate of discharge.
- **Gravel or Stone Flow Spreaders (concentrated flow).** The gravel flow spreader is located at curb cuts, downspouts, or other concentrated inflow points, and should have a 2- to 4-inch elevation drop from a hard-edged surface into a gravel or stone diaphragm. The gravel should extend the entire width of the opening and create a level stone weir at the bottom or treatment elevation of the channel.
- **Initial Sediment Forebay (channel flow).** This grassed cell is located at the upper end of the open channel segment with a recommended 2:1 length to width ratio and a storage volume equivalent to at least 15% of the total design storm volume. If the volume of the forebay will be included as part of the dry swale storage volume, the forebay must de-water between storm events. It cannot have a permanent ponded volume.

### 3.9.4 Open Channel Design Criteria

**Channel Geometry.** Design guidance regarding the geometry and layout of open channels is provided below:

- Open channels should generally be aligned adjacent to and the same length as the CDA identified for treatment.
- Open channels should be designed with a trapezoidal or parabolic cross section. A parabolic shape is preferred for aesthetic, maintenance, and hydraulic reasons.
- The bottom width of the channel should be between 4 to 8 feet wide to ensure that an adequate surface area exists along the bottom of the swale for filtering. If a channel will be wider than 8 feet, the designer must incorporate benches, check dams, level spreaders, or multi-level cross sections to prevent braiding and erosion along the channel bottom.
- Open-channel side slopes should be no steeper than 3H:1V for ease of mowing and routine maintenance. Flatter slopes are encouraged, where adequate space is available, to enhance pretreatment of sheet flows entering the channel.

**Check dams.** Check dams may be used for pretreatment, to break up slopes, and to increase the hydraulic residence time in the channel. Design requirements for check dams are as follows:

- Check dams should be spaced based on the channel slope, as needed to increase residence time, provide design storm storage volume, or any additional volume attenuation requirements. In typical spacing, the ponded water at a downhill check dam should not touch the toe of the upstream check dam. More frequent spacing may be desirable in dry swales to increase the ponding volume.

- The maximum desired check dam height is 12 inches, for maintenance purposes. However, for some sites, a maximum of 18 inches can be allowed, with additional design elements to ensure the stability of the check dam and the adjacent and underlying soils.
- Armoring may be needed at the downstream toe of the check dam to prevent erosion.
- Check dams must be firmly anchored into the side-slopes to prevent outflanking; check dams must also be anchored into the channel bottom so as to prevent hydrostatic head from pushing out the underlying soils.
- Check dams must be designed with a center weir sized to pass the channel design storm peak flow (15-year storm event for man-made channels).
- For grass channels, each check dam must have a weep hole or similar drainage feature so it can dewater after storms. This is not appropriate for dry swales.
- Check dams should be composed of wood, concrete, stone, compacted soil, or other non-erodible material, or should be configured with elevated driveway culverts.
- Individual channel segments formed by check dams or driveways should generally be at least 25 to 40 feet in length.

Check dams for grass channels must be spaced to reduce the effective slope to less than 2%, as indicated in Table 3-32.

**Table 3-32 Typical Check Dam Spacing to Achieve Effective Channel Slope**

Channel Longitudinal Slope (%)	Check Dam <sup>a, b</sup> Spacing <sup>c</sup> to Achieve Effective Slope (ft)	
	Effective Slope of 2%	Effective Slope of 0%–1%
0.5	–	200–
1.0	–	100–
1.5	–	67–200
2.0	–	50–100
2.5	200	40–67
3.0	100	33–50
3.5	67	30–40
4.0	50	25–33
4.5 <sup>d</sup>	40	20–30
5.0 <sup>d</sup>	40	20–30

<sup>a</sup> Check dams may require a stone energy dissipator at the downstream toe.

<sup>b</sup> Check dams require weep holes at the channel invert. Swales with slopes less than 2% will require multiple weep holes (at least 3) in each check dam.

<sup>c</sup> Maximum check dam spacing height is 12 inches. The spacing dimension is half of the above distances if a 6-inch check dam is used.

<sup>d</sup> Open channels with slopes greater than 4% require special design considerations, such as drop structures to accommodate greater than 12-inch high check dams (and therefore a flatter effective slope), in order to ensure non-erosive flows.



**Ponding Depth.** Check dams must be used in dry swales to create ponding cells along the length of the channel. The maximum ponding depth in a dry swale must not exceed 18 inches. Minimum surface ponding depth is 3 inches (averaged over the surface area of the open channel). In order to increase the ponding depth, it may be necessary or desirable to space check dams more frequently than is shown in Table 3-33.

**Dry Swale Filter Media.** Dry swales require replacement of native soils with a prepared filter media. The filter media provides adequate drainage, supports plant growth, and facilitates pollutant removal within the dry swale. At least 18 inches of filter media must be added above the choker stone layer (and no more than 6 feet) to create an acceptable filter. The recipe for the filter media is identical to that used for bioretention and is provided in Section 3.6, “Bioretention.” The batch receipt confirming the source of the filter media must be submitted to the DOEE inspector. One acceptable design adaptation is to use 100% sand for the first 18 inches of the filter and add a combination of topsoil and compost, as specified in Appendix K - Soil Compost Amendment Requirements for the top 4 inches, where turf cover will be maintained.

**Dry Swale Drawdown.** Dry swales must be designed so that the desired design storm volume is completely filtered within 72 hours, using the equations specified in Section 3.9.6, “Open Channel Construction Sequence.”

**Dry Swale Underdrain.** Some dry swale designs will not use an underdrain (where soil infiltration rates meet minimum standards). See Section 3.9.1 Open Channel Feasibility Criteria for more details. When underdrains are necessary, they should have a minimum diameter of 4 to 6 inches and be encased in a 12-inch deep gravel bed. Two layers of stone should be used. A choker stone layer, consisting of No. 8 or No. 89 stone at least 3 inches deep, must be installed immediately below the filter media. Below the choker stone layer, the underdrain must be encased (a minimum of 2 inches above and below the underdrain) in a layer of ASTM D448 No.57 or smaller (No. 68, 8, or 89) stone washed clean and free of fines. The maximum depth of the underdrain stone layer combined with the choking layer is 12 inches, and it cannot extend beyond the surface dimensions of the dry swale filter media.

**Impermeable Liner.** An impermeable liner is not typically required, although it may be utilized in fill applications where deemed necessary by a geotechnical investigation, on sites with contaminated soils, or on the sides of the practice to protect adjacent structures from seepage. Use a PVC geomembrane liner or an equivalent of an appropriate thickness (follow manufacturer’s instructions for installation). Field seams must be sealed according to the liner manufacturer’s specifications. A minimum 6-inch overlap of material is required at all seams.

**Dry Swale Observation Well.** A dry swale must include well-anchored, 4- to 6-inch diameter PVC pipe observation wells along the length of the swale. For a dry swale with an underdrain, the wells should be tied into any Ts or Ys in the underdrain system and must extend upward above the surface of the ponding. These observation wells may double as clean outs. For an infiltrating dry swale, the observation well should be perforated in the gravel layer only.

**Grass Channel Material Specifications.** The basic material specifications for grass channels are outlined in Table 3-33.

**Table 3-33 Grass Channel Material Specifications**

Component	Specification
Grass	<p>A dense cover of water-tolerant, erosion-resistant grass. The selection of an appropriate species or mixture of species is based on several factors including climate, soil type, topography, and sun or shade tolerance.</p> <p>Grass species should have the following characteristics:</p> <ul style="list-style-type: none"> <li>▪ A deep root system to resist scouring;</li> <li>▪ A high stem density with well-branched top growth;</li> <li>▪ Water-tolerance;</li> <li>▪ Resistance to being flattened by runoff;</li> <li>▪ An ability to recover growth following inundation; and</li> <li>▪ If receiving runoff from roadways, salt-tolerance.</li> </ul>
Check Dams	<p>Check dams should be constructed of a non-erodible material such as wood, gabions, riprap, or concrete. Wood used for check dams should consist of pressure-treated logs or timbers or water-resistant tree species such as cedar, hemlock, swamp oak, or locust.</p>
Diaphragm	<p>Pea gravel used to construct pretreatment diaphragms must consist of washed, open-graded, course aggregate between 3 and 10 mm in diameter.</p>
Erosion Control Fabric	<p>Where flow velocities dictate, biodegradable erosion control netting or mats that are durable enough to last at least two growing seasons must be used, conforming to Standard and Specification 3.36 of the Virginia Erosion and Sediment Control Handbook.</p>

**Dry Swale Material Specifications.** For additional material specifications pertaining to dry swales, designers should consult Section 3.6.4 Bioretention Design Criteria and Table 3-34.

**Table 3-34 Dry Swale Material Specifications**

Material	Specification	Notes
Filter Media Composition	Filter Media to contain: <ul style="list-style-type: none"> <li>▪ 80%–90% sand</li> <li>▪ 10%–20% soil fines</li> <li>▪ Maximum 10% clay</li> <li>▪ 3%–5% organic matter</li> </ul>	To account for settling/compaction, it is recommended that 110% of the plan volume be utilized.
Filter Media Testing	P content = 5 to 15 mg/kg (Mehlich I) or 18 to 40 mg/kg (Mehlich III) CEC > 5 milliequivalents per 100 grams	See Section 3.6 Bioretention, for additional filter media information.
Geotextile	Geotextile fabric meeting the following specifications: <ul style="list-style-type: none"> <li>▪ AASHTO M-288 Class 2, latest edition</li> <li>▪ Has a permeability of at least an order of magnitude (10 times) higher than the soil subgrade permeability.</li> <li>▪ Apply along sides of the filter media only and do not apply along the swale bottom.</li> </ul>	
Choking Layer	A 2- to 4-inch layer of choker stone (typically No. 8 or No. 89 washed gravel) laid above the underdrain stone.	
Underdrain Stone Layer	Stone must be washed clean and free of fines (no more than 2% passing the No. 200 sieve) (ASTM D448 No. 57 or smaller stone).	
Underdrains and Cleanouts	4-inch or 6-inch rigid schedule 40 PVC pipe, with 3 or 4 rows of 3/8-inch perforations at 6 inches on center.	Install perforated pipe for the full length of the dry swale cell. Use non-perforated pipe, as needed, to connect with the storm drain system.
Observation Wells	4-inch or 6-inch rigid schedule 40 PVC pipe	For dry swales with underdrains, tie the non-perforated observation well to the underdrain via T or Y connection. This observation well can double as a cleanout. For dry swales without an underdrain, the pipe should only be perforated in the gravel layer. The observation wells should extend to the top of ponding.
Impermeable Liner	Where appropriate, use a PVC geomembrane liner or equivalent.	
Vegetation	Plant species as specified on the landscaping plan.	
Check Dams	Use non-erosive material, such as wood, gabions, riprap, or concrete. Wood used for check dams should consist of pressure-treated logs or timbers, or water-resistant tree species, such as cedar, hemlock, swamp oak, or locust.	
Erosion Control Fabric	Where flow velocities dictate, use woven biodegradable erosion control fabric or mats (EC2) that are durable enough to last at least 2 growing seasons.	

**Wet Swale Design Issues.** The following criteria apply to the design of wet swales:

- The average normal pool depth (dry weather) throughout the swale must be 6 inches or less.
- The maximum temporary ponding depth in any single wet swale cell must not exceed 18 inches at the most downstream point (e.g., at a check dam or driveway culvert).
- Check dams should be spaced as needed to maintain the effective longitudinal slope.

- Individual wet swale segments formed by check dams or driveways should generally be at least 25 to 40 feet in length.
- Wet swale side slopes should be no steeper than 4H:1V to enable wetland plant growth. Flatter slopes are encouraged where adequate space is available, to enhance pretreatment of sheet flows entering the channel. Under no circumstances are side slopes to be steeper than 3H:1V.

**Grass Channel Enhancement using Compost Soil Amendments.** Soil compost amendments serve to increase the retention capability of a grass channel. The following design criteria apply when compost amendments are used:

- The compost-amended strip must extend over the length and width of the channel bottom, and the compost must be incorporated to a depth as outlined in Appendix K - Soil Compost Amendment Requirements.
- The amended area will need to be rapidly stabilized with perennial, salt-tolerant grass species (if contributing impervious surfaces are likely to be salted).
- For grass channels on steep slopes, it may be necessary to install a protective biodegradable erosion control mat to protect the compost-amended soils. Care must be taken to consider the erosive characteristics of the amended soils when selecting an appropriate erosion control mat.

**Grass Channel Sizing.** Unlike other BMPs, grass channels are designed based on a peak rate of flow. Designers must demonstrate channel conveyance and treatment capacity in accordance with the following guidelines:

- Hydraulic capacity should be verified using Manning's Equation or an accepted equivalent method, such as erodibility factors and vegetal retardance.
- The flow depth for the peak flow generated by the SWRv must be maintained at 4 inches or less.
- Manning's "n" value for grass channels is 0.2 for flow depths up to 4 inches, decreasing to 0.03 at a depth of 12 inches and above, which would apply to the 2-year and 15-year storms if an on-line application (Haan et. al, 1994).
- Peak flow rates for the 2-year and 15-year frequency storms must be non-erosive, in accordance with Table 3-35 (see Section 3.9.5 Open Channel Landscaping Criteria), or subject to a site-specific analysis of the channel lining material and vegetation; and the 15-year peak flow rate must be contained within the channel banks (with a minimum of 6 inches of freeboard).
- Calculations for peak flow depth and velocity must reflect any increase in flow along the length of the channel, as appropriate. If a single flow is used, the flow at the outlet must be used.
- The hydraulic residence time (e.g., the average travel time for a particle of water through a waterbody) must be a minimum of 9 minutes for the peak flows from the SWRv or design storm (Mar et al., 1982; Barrett et al., 1998; Washington State Department of Ecology,

2005). If flow enters the swale at several locations, a 9-minute minimum hydraulic residence time must be demonstrated for each entry point, using Equation 3.17 through Equation 3.21.

The bottom width of the grass channel is therefore sized to maintain the appropriate flow geometry as follows:

### Equation 3.17 Manning's Equation

$$V = \left(\frac{1.49}{n}\right) \times D^{2/3} \times S^{1/2}$$

where:

- $V$  = flow velocity (ft/s)
- $n$  = roughness coefficient (0.2, or as appropriate)
- $D$  = flow depth (ft) (Note:  $D$  approximates hydraulic radius for shallow flows)
- $S$  = channel slope (ft/ft)

### Equation 3.18 Continuity Equation

$$Q = V \times (W + 3 \times D) \times D$$

where:

- $Q$  = design storm peak flow rate (cfs)
  - $V$  = design storm flow velocity (ft/s)
  - $W$  = channel bottom width (ft)
  - $D$  = flow depth (ft)
- (Note: Channel width ( $W$ ) plus 3 times the depth ( $D$ ) represents the average width of a trapezoidal channel with 3H:1V side slopes. Average width multiplied by depth equals the cross-sectional flow area.)

Combining Equation 3.17 and Equation 3.18, and rewriting them provides a solution for the minimum width (Equation 3.19):

**Equation 3.19 Minimum Width**

$$W = \frac{n \times Q}{1.49 \times D^{5/3} \times S^{1/2}} - (3 \times D)$$

where:

- $W$  = channel bottom width (ft)
- $n$  = roughness coefficient (0.2, or as appropriate)
- $Q$  = design storm peak flow rate (cfs)
- $D$  = flow depth (ft)
- $S$  = channel slope (ft/ft)

Equation 3.20 provides the corresponding velocity:

**Equation 3.20 Corresponding Velocity**

$$V = \frac{Q}{(W + 3 \times D) \times D}$$

where:

- $V$  = design storm flow velocity (ft/s)
- $Q$  = design storm peak flow rate (cfs)
- $W$  = channel bottom width (ft)
- $D$  = flow depth (ft)

The width, slope, or Manning's "n" value can be adjusted to provide an appropriate channel design for the site conditions. However, if a higher density of grass is used to increase the Manning's "n" value and decrease the resulting channel width, it is important to provide material specifications and construction oversight to ensure that the denser vegetation is actually established. Equation 3.21 can then be used to ensure adequate hydraulic residence time.

**Equation 3.21 Grass Channel Length for Hydraulic Residence Time of 9 minutes (540 seconds)**

$$L = 540 \times V$$

where:

- $L$  = minimum swale length (ft)
- $V$  = flow velocity (ft/s)

The storage volume ( $S_v$ ) provided by the grass channel is equal to the total runoff from the design storm (typically  $SWR_v$ ) used to size the channel (conveyed at a depth of 4 inches or less), as shown in Equation 3.22.

**Equation 3.22 Grass Channel Storage Volume**

$$Sv = DesignStorm$$

where:

$$\begin{aligned} Sv &= \text{total storage volume of grass channel (ft}^3\text{)} \\ DesignStorm &= \text{SWRv or other design storm volume (ft}^3\text{)} \\ &\text{(e.g., portion of the SWRv)} \end{aligned}$$

**Dry Swale Sizing.** Dry swales are typically sized to capture the SWRv or larger design storm volumes in the surface ponding area, filter media, and gravel reservoir layers of the dry swale.

Total storage volume of the BMP is calculated using Equation 3.23.

**Equation 3.23 Dry Swale Storage Volume**

$$Sv = SA_{bottom} \times [(d_{media} \times \eta_{media}) + (d_{gravel} \times \eta_{gravel})] + (SA_{average} \times d_{ponding})$$

where:

$$\begin{aligned} Sv &= \text{total storage volume of dry swale (ft}^3\text{)} \\ SA_{bottom} &= \text{bottom surface area of dry swale (ft}^2\text{)} \\ d_{media} &= \text{depth of the filter media, including mulch layer (ft)} \\ \eta_{media} &= \text{effective porosity of the filter media (typically 0.25)} \\ d_{gravel} &= \text{depth of the underdrain and underground storage gravel layer,} \\ &\text{including choker stone (ft)} \\ \eta_{gravel} &= \text{effective porosity of the gravel layer (typically 0.4)} \\ SA_{average} &= \text{average surface area of the dry swale (ft}^2\text{)} \\ &\text{typically, where } SA_{top} \text{ is the top surface area of dry swale,} \\ &SA_{average} = \frac{SA_{bottom} + SA_{top}}{2} \\ d_{ponding} &= \text{the maximum ponding depth of the dry swale (ft)} \end{aligned}$$

Equation 3.23 can be modified if the storage depths of the filter media, gravel layer, or ponded water vary in the actual design or with the addition of any surface or subsurface storage components (e.g., additional area of surface ponding, subsurface storage chambers, etc.). The maximum depth of ponding in the dry swale must not exceed 18 inches. If storage practices will be provided off-line or in series with the dry swale, the storage practices should be sized using the guidance in Section 3.12, “Storage Practices.”

Dry swales can be designed to address, in whole or in part, the detention storage needed to comply with channel protection and/or flood control requirements. The Sv can be counted as part of the 2-year or 15-year runoff volumes to satisfy stormwater quantity control requirements.

Note: In order to increase the storage volume of a dry swale, the ponding surface area may be increased beyond the filter media surface area. However, the top surface of the BMP (at the top of the ponding elevation) may not be more than twice the size of surface area of the filter media ( $SA_{bottom}$ ).

**Wet Swale Sizing.** Wet swales can be designed to capture and treat the SWR<sub>v</sub> remaining from any upstream stormwater retention practices. The storage volume is made up of the temporary and permanent storage created within each wet swale cell. This includes the permanent pool volume and up to 12 inches of temporary storage created by check dams or other design features that has 24 hours extended detention.

The storage volume ( $S_v$ ) of the practice is equal to the volume provided by the pond permanent pool plus the 24-hour extended detention (ED) volume provided by the practice (Equation 3.24). The total  $S_v$  cannot exceed the design SWR<sub>v</sub>.

### Equation 3.24 Wet Swale Storage Volume

$$S_v = \text{Pond permanent pool volume} + 24 \text{ hour ED volume}$$

### 3.9.5 Open Channel Landscaping Criteria

All open channels must be stabilized to prevent erosion or transport of sediment to receiving practices or drainage systems. There are several types of grasses appropriate for dry open channels (grass channels and dry swales). These are listed in Table 3-35. Designers should choose plant species that can withstand both wet and dry periods and relatively high velocity flows for planting within the channel. Designers should ensure that the maximum flow velocities do not exceed the values listed in the table for the selected grass species and the specific site slope.

**Table 3-35 Recommended Vegetation for Open Channels**

Vegetation Type	Slope (%)	Maximum Velocity (ft/s)	
		Erosion Resistant Soil	Easily Eroded Soil
Bermuda Grass	0–5	8	6
	5–10	7	5
	>10	6	4
Kentucky Bluegrass	0–5	7	5
	5–10	6	4
	>10	5	3
Tall Fescue Grass Mixture	0–5	6	4
	5–10	4	3
Annual and Perennial Rye	0–5	4	3
Sod		4	3

Source: USDA, TP-61, 1954; Roanoke Virginia, Stormwater Design Manual, 2008



Wet swales should be planted with grass and wetland plant species that can withstand both wet and dry periods as well as relatively high velocity flows within the channel. For a list of wetland plant species suitable for use in wet swales, refer to the wetland planting guidance and plant lists provided in Section 3.11, “Stormwater Wetlands.”

If roadway salt will be applied to the CDA, open channels should be planted with salt-tolerant plant species.

Landscape design shall specify proper grass species based on site-specific soils and hydric conditions present along the channel.

Open channels should be seeded at such a density to achieve a 90% vegetated cover after the second growing season. Taller and denser grasses are preferable, although the species is less important than good stabilization and dense vegetative cover.

Grass channels should be seeded and not sodded. Seeding establishes deeper roots and sod may have muck soil that is not conducive to infiltration. Grass channels should be protected by a biodegradable erosion control fabric to provide immediate stabilization of the channel bed and banks.

### 3.9.6 Open Channel Construction Sequence

**Design Notes.** Channel invert and tops of banks are to be shown in plan and profile views. A cross sectional view of each configuration and completed limits of grading must be shown for proposed channels. For proposed channels, the transition at the entrance and outfall is to be clearly shown on plan and profile views.

**Open Channel Installation.** The following is a typical construction sequence to properly install open channels, although steps may be modified to reflect different site conditions or design variations. Grass channels should be installed at a time of year that is best to establish turf cover without irrigation. For more specific information on the installation of wet swales, designers should consult the construction criteria outlined in Section 3.11, “Stormwater Wetlands.”

**Step 1: Protection During Site Construction.** Ideally, open channels should remain outside the limits of disturbance during construction to prevent soil compaction by heavy equipment. However, this is seldom practical, given that the channels are a key part of the drainage system at most sites. In these cases, temporary soil erosion and sediment controls such as dikes, silt fences, and other erosion control measures should be integrated into the swale design throughout the construction sequence. Specifically, barriers should be installed at key check dam locations, and erosion control fabric should be used to protect the channel. Dry swales that lack underdrains (and rely on infiltration) must be fully protected by silt fence or construction fencing to prevent compaction by heavy equipment during construction.

**Step 2: Installation.** Installation may only begin after the entire CDA has been stabilized with vegetation. Any accumulation of sediments that does occur within the channel must be removed during the final stages of grading to achieve the design cross section. Soil erosion and sediment controls for construction of the channel must be installed as specified in the soil erosion

and sediment control plan. Stormwater flows must not be permitted into the channel until the bottom and side slopes are fully stabilized.

**Step 3: Grading.** Grade the grass channel to the final dimensions shown on the plan. Excavators or backhoes should work from the sides to grade and excavate the open channels to the appropriate design dimensions. Excavating equipment should have scoops with adequate reach so they do not have to sit inside the footprint of the open channel area. If constructing a dry swale, the bottom of the swale should be ripped, rototilled or otherwise scarified to promote greater infiltration.

**Step 4: Placing Stone Layer (for dry swales).** If constructing a dry swale, place an acceptable geotextile fabric on the underground (excavated) sides of the dry swale with a minimum 6-inch overlap. Place the stone needed for storage layer over the filter bed. Add the perforated underdrain pipe. Add the remaining stone jacket, and then pack No. 57 stone (washed clean and free of fines) to 3 inches above the top of the underdrain, and then add 3 inches of pea gravel as a filter layer. Add the filter media in 12-inch lifts until the desired top elevation of the dry swale is achieved. Water thoroughly and add additional media as needed where settlement has occurred.

**Step 5: Add Amendments (optional, for grass channels).** Add soil amendments as needed. Till the bottom of the grass channel to a depth of 1 foot and incorporate compost amendments according to Appendix K - Soil Compost Amendment Requirements.

**Step 6: Install Check Dams.** Install check dams, driveway culverts and internal pretreatment features as shown on the plan. Fill material used to construct check dams should be placed in 8- to 12-inch lifts and compacted to prevent settlement. The top of each check dam must be constructed level at the design elevation.

**Step 7: Hydro-seed.** Hydro-seed the bottom and banks of the open channel, and peg in erosion control fabric or blanket where needed. After initial planting, a biodegradable erosion control fabric should be used, conforming to the District of Columbia Soil Erosion and Sediment Control Standards and Specifications.

**Step 8: Plant.** Plant landscaping materials as shown in the landscaping plan, and water them weekly during the first 2 months. The construction contract should include a care and replacement warranty to ensure that vegetation is properly established and survives during the first growing season following construction.

**Step 9: Final Inspection.** A qualified professional should conduct the final construction inspection and develop a punch list for facility acceptance.

**Open Channel Construction Supervision.** Supervision during construction is recommended to ensure that the open channel is built in accordance with these specifications.

DOEE's construction phase inspection checklist is available in Appendix L - Construction Inspection Checklists.

Some common pitfalls can be avoided by careful construction supervision that focuses on the following key aspects of dry swale installation:

- Make sure the desired coverage of turf or erosion control fabric has been achieved following construction, both on the channel beds and their contributing side-slopes.
- Inspect check dams and pretreatment structures to make sure they are at correct elevations, are properly installed, and are working effectively.
- For dry swale designs:
  - ◆ Check the filter media to confirm that it meets specifications and is installed to the correct depth.
  - ◆ Check elevations, such as the invert of the underdrain, inverts for the inflow and outflow points, and the ponding depth provided between the surface of the filter bed and the overflow structure.
  - ◆ Ensure that caps are placed on the upstream (but not the downstream) ends of the underdrains.
  - ◆ Check that outfall protection/energy dissipation measures at concentrated inflow and outflow points are stable.

The real test of an open channel occurs after its first big storm. The post-storm inspection should focus on whether the desired sheetflow, shallow concentrated flows or fully concentrated flows assumed in the plan actually occur in the field. Minor adjustments are normally needed as part of this post-storm inspection (e.g., spot reseeding, gully repair, added armoring at inlets, or realignment of outfalls and check dams). Also, a qualified professional should check that dry swale practices drain completely within the 72-hour drawdown period.

### **3.9.7 Open Channel Maintenance Criteria**

Maintenance is a crucial and required element that ensures the long-term performance of open channels. Once established, grass channels have minimal maintenance needs outside of the spring cleanup, regular mowing, repair of check dams, and other measures to maintain the hydraulic efficiency of the channel and a dense, healthy grass cover. Dry swale designs may require regular pruning and management of trees and shrubs. The surface of dry swale filter beds can become clogged with fine sediment over time, but this can be alleviated through core aeration or deep tilling of the filter bed. Additional effort may be needed to repair check dams, stabilize inlet points, and remove deposited sediment from pretreatment cells. Table 3-36 provides a schedule of typical maintenance activities required for open channels.

**Table 3-36 Typical Maintenance Activities and Schedule for Open Channels**

Schedule	Maintenance Activity
As needed	<ul style="list-style-type: none"> <li>▪ Mow grass channels and dry swales during the growing season to maintain grass heights in the 4- to 6-inch range.</li> </ul>
Quarterly	<ul style="list-style-type: none"> <li>▪ Ensure that the CDA, inlets, and facility surface are clear of debris.</li> <li>▪ Ensure that the CDA is stabilized. Perform spot-reseeding if where needed.</li> <li>▪ Remove accumulated sediment and oil/grease from inlets, pretreatment devices, flow diversion structures, and overflow structures.</li> <li>▪ Repair undercut and eroded areas at inflow and outflow structures.</li> </ul>
Annual inspection	<ul style="list-style-type: none"> <li>▪ Add reinforcement planting to maintain 90% turf cover. Reseed any salt-killed vegetation.</li> <li>▪ Remove any accumulated sand or sediment deposits behind check dams.</li> <li>▪ Inspect upstream and downstream of check dams for evidence of undercutting or erosion, and remove trash or blockages at weep holes.</li> <li>▪ Examine channel bottom for evidence of erosion, braiding, excessive ponding, or dead grass.</li> <li>▪ Check inflow points for clogging and remove any sediment.</li> <li>▪ Inspect side slopes and grass filter strips for evidence of any rill or gully erosion and repair.</li> <li>▪ Look for any bare soil or sediment sources in the CDA and stabilize immediately.</li> </ul>

**Maintenance Inspections.** Annual inspections by a qualified professional are used to trigger maintenance operations, such as sediment removal, spot revegetation, and inlet stabilization. DOEE’s maintenance inspection checklists for disconnection and the Maintenance Service Completion Inspection form can be found in Appendix M - Maintenance Inspection Checklists.

**Declaration of Covenants.** A declaration of covenants that includes all maintenance responsibilities to ensure the continued stormwater performance for the BMP is required. The declaration of covenants specifies the property owner’s primary maintenance responsibilities, and authorizes DOEE staff to access the property for inspection or corrective action in the event the proper maintenance is not performed. The declaration of covenants is recorded in the District of Columbia land records. A template form is provided at the end of Chapter 5 Administration of Stormwater Management Rules (see Figure 5.11), although variations will exist for scenarios where stormwater crosses property lines. The covenant is between the property and the Government of the District of Columbia. It is submitted through the Office of the Attorney General. All SWMPs have a maintenance agreement stamp that must be signed for a building permit to proceed. A maintenance schedule must appear on the SWMP. Additionally, a maintenance schedule is required in Exhibit C of the declaration of covenants.

Covenants are not required on government properties, but maintenance responsibilities must be defined through a partnership agreement or a memorandum of understanding.

**Waste Material.** Waste material from the repair, maintenance, or removal of a BMP or land cover shall be removed and disposed of in compliance with applicable federal and District law.

### 3.9.8 Open Channel Stormwater Compliance Calculations

Grass Channels receive 10% retention value and are not an accepted total suspended solids practice for the amount of storage volume (Sv) provided by the BMP (Table 3-37).

**Table 3-37 Grass Channel Retention Value and Pollutant Removal**

Retention Value	$= 0.1 \times Sv$
Accepted Total Suspended Solids (TSS) Treatment Practice	No

Grass channels on amended soils receive 30% retention value for the amount of storage volume ( $Sv$ ) provided by the practice (Table 3-38).

**Table 3-38 Standard Bioretention Design Retention Value and Pollutant Removal**

Retention Value	$= 0.3 \times Sv$
Accepted TSS Treatment Practice	No

Dry swales receive 60% retention value and are an accepted TSS removal practice for the amount of storage volume ( $Sv$ ) provided by the practice (Table 3-39).

**Table 3-39 Dry Swale Retention Value and Pollutant Removal**

Retention Value	$= 0.6 \times Sv$
Accepted TSS Treatment Practice	Yes

Wet swales receive 10% retention value and are an accepted TSS removal practice for the amount of storage volume ( $Sv$ ) provided by the BMP (Table 3-40).

**Table 3-40 Wet Swale Retention Value and Pollutant Removal**

Retention Value	$= 0.1 \times Sv$
Accepted TSS Treatment Practice	Yes

All practices must be sized using the guidance detailed in Section 3.9.4, “Open Channel Design Criteria.”

Grass channels and dry swales also contribute to peak flow reduction. This contribution can be determined in several ways. One method is to subtract the storage volume ( $Sv$ ) or retention value from the total runoff volume for the 2-year, 15-year, and 100-year storms. The resulting reduced runoff volumes can then be used to calculate a reduced NRCS CN for the site or SDA. The reduced NRCS CN can then be used to calculate peak flow rates for the various storm events. Other hydrologic modeling tools that employ different procedures may be used as well.

### 3.9.9 References

ASTM D448-12(2017), Standard Classification for Sizes of Aggregate for Road and Bridge Construction, ASTM International, West Conshohocken, PA, 2017, [www.astm.org](http://www.astm.org)

Barrett, Michael E., Michael V. Keblin, Patrick M. Walsh, Joseph F. Malina, Jr., and Randall J. Charbeneau. 1998. Evaluation of the Performance of Permanent Runoff Controls: Summary and Conclusions. Center for Transportation Research Bureau of Engineering Research. The University of Texas at Austin. Available online at: [http://www.utexas.edu/research/ctr/pdf\\_reports/2954\\_3F.pdf](http://www.utexas.edu/research/ctr/pdf_reports/2954_3F.pdf)

Haan, C.T., B.J Barfield., and J.C. Hayes, Design Hydrology and Sedimentology for Small Catchments. Academic Press, New York, 1994.

Mar, B.W., R.R. Horner, J.F. Ferguson, D.E. Spyridakis, E.B. Welch. 1982. Summary "C Highway Runoff Water Quality Study, 1977 "C 1982. WA RD 39.16. September, 1982.

Roanoke Virginia, Stormwater Design Manual. 2008. Stormwater Management Design Manual. Department of Planning Building and Development. Roanoke, Virginia.

USDA. 1954. Handbook of Channel of Design for Soil and Water Conservation. Stillwater Outdoor Hydraulic Laboratory and the Oklahoma Agricultural Experiment Station. SCS-TP-61, Washington, DC.

Virginia DCR Stormwater Design Specification No. 3: Grass Channels Version 1.8. 2010.

Virginia DCR Stormwater Design Specification No. 10: Dry Swales Version 1.8. 2010.

Virginia DCR Stormwater Design Specification No. 11: Wet Swales Version 1.8. 2010.

Washington State Department of Ecology. 2005. Stormwater Manual for Western Washington. State of Washington Department of Ecology. Available online at: <https://ecology.wa.gov/Regulations-Permits/Guidance-technical-assistance/Stormwater-permittee-guidance-resources/Stormwater-manuals>

### 3.10 Ponds

**Definition.** Stormwater ponds are stormwater storage practices that consist of a combination of a permanent pool, micropool, or shallow marsh that promote a good environment for gravitational settling of particulates, biological uptake that results in nutrient removal, and microbial activity that can reduce nitrogen concentrations in runoff. Ponds are best suited for larger SDAs. Runoff from each new storm enters the pond and partially displaces pool water from previous storms. The pool also acts as a barrier to resuspension of sediments and other pollutants deposited during prior storms. When sized properly, stormwater ponds have a residence time that ranges from many days to several weeks, which allows numerous pollutant removal mechanisms to operate. Stormwater ponds can also provide storage above the permanent pool to help meet stormwater management requirements for larger storms. Design variants include the following (see Figure 3.39 and Figure 3.40):

- C-1 Micropool extended detention pond
- C-2 Wet pond
- C-3 Wet extended detention pond

Stormwater ponds should be considered for use after all other upland retention opportunities have been exhausted and there is still a remaining treatment volume or runoff from larger storms (i.e., 2-year, 15-year or flood control events) to manage.

Stormwater ponds receive only 10% stormwater retention value and should be considered mainly for management of larger storm events. Stormwater ponds have both community and environmental concerns (see Section 3.10.1 Pond Feasibility Criteria) that should be considered before choosing stormwater ponds as the appropriate stormwater practice on-site.

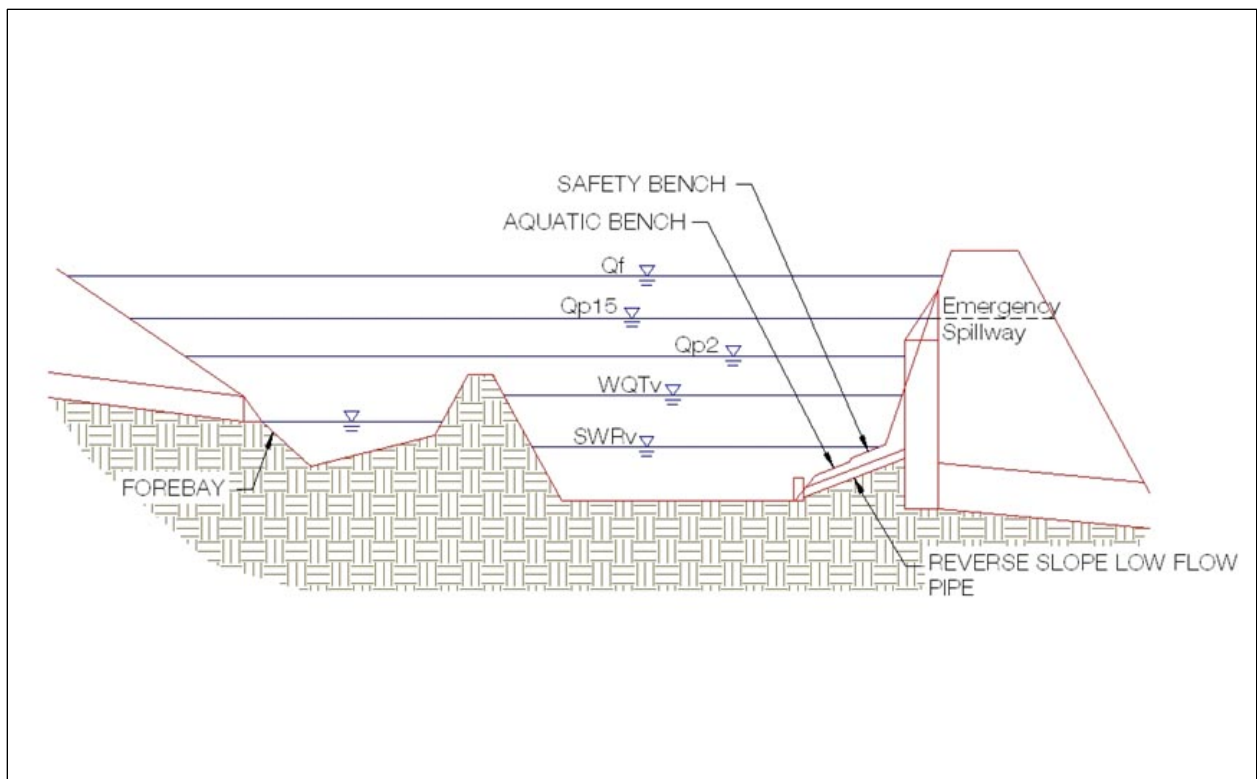
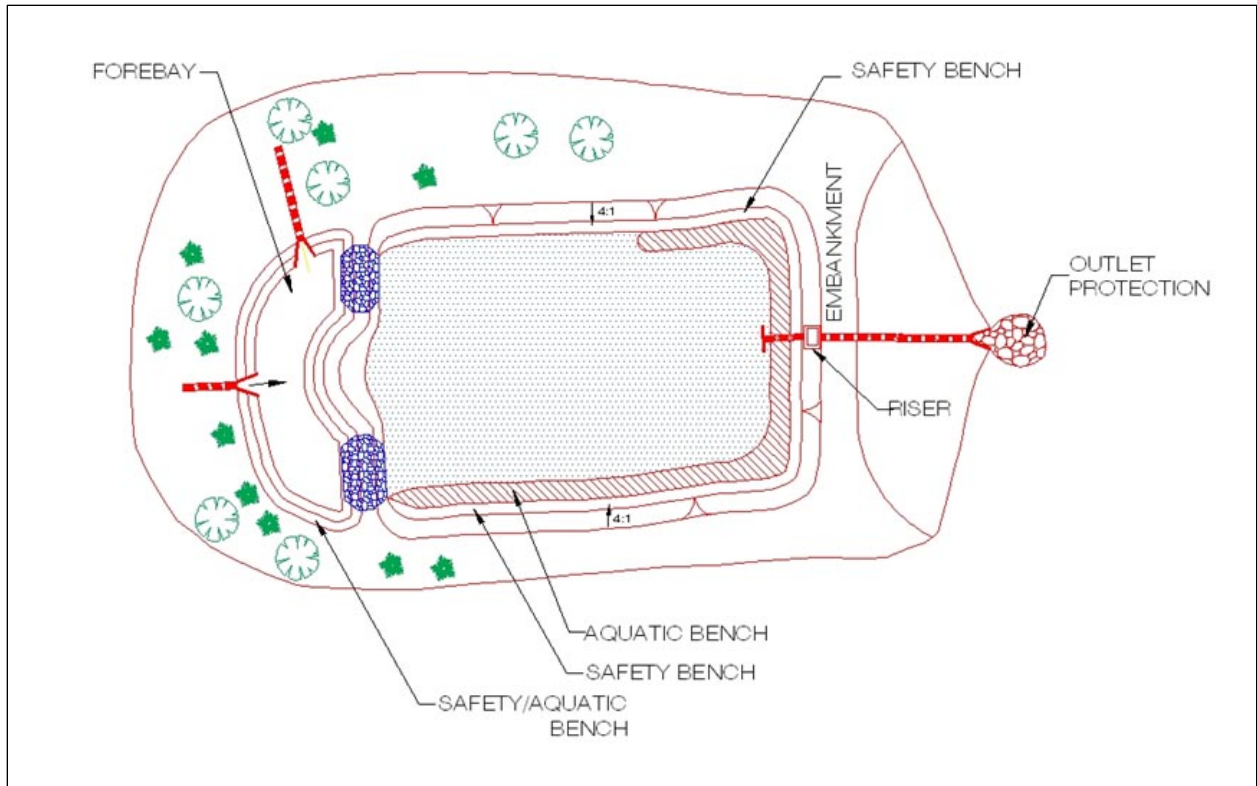


Figure 3.39 Design schematics for a wet pond (C-2).



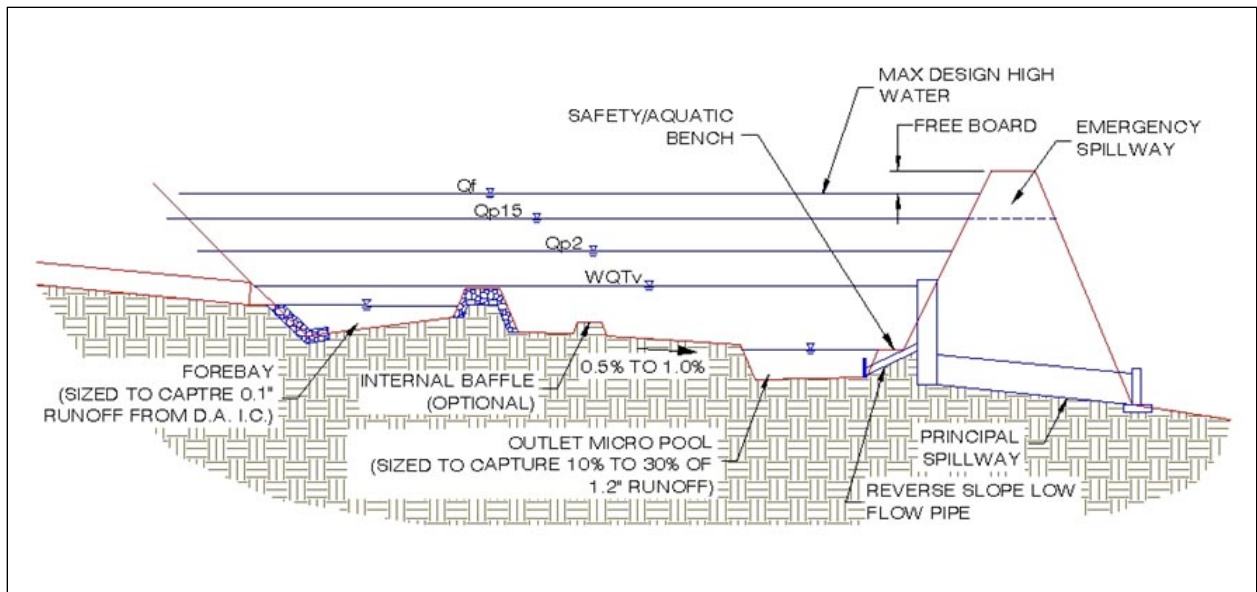
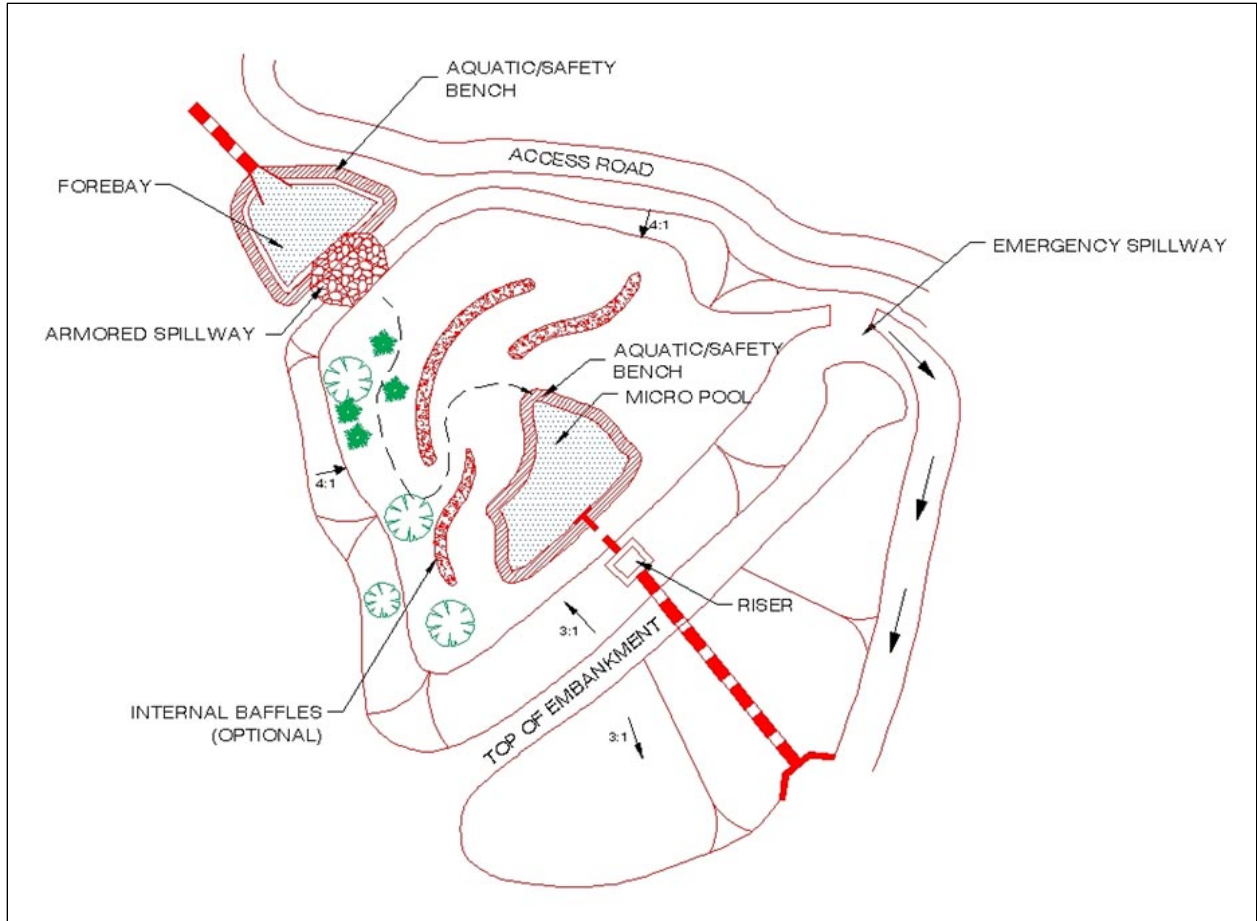


Figure 3.40 Typical extended detention pond (C-3) details.

### 3.10.1 Pond Feasibility Criteria

The following feasibility issues need to be considered when ponds are considered a final stormwater management practice of the treatment train.

**Adequate Water Balance.** Wet ponds must have enough water supplied from groundwater, runoff, or baseflow so that the wet pools will not draw down by more than 2 feet after a 30-day summer drought. A simple water balance calculation must be performed using the Equation 3.26 in Section 3.10.4, “Pond Design Criteria.”

**Contributing Drainage Area.** A CDA of 10 to 25 acres is typically recommended for ponds to maintain constant water elevations. Ponds can still function with CDAs less than 10 acres, but designers should be aware that these “pocket” ponds will be prone to clogging, experience fluctuating water levels, and generate more nuisance conditions.

**Space Requirements.** The surface area of a pond will normally be at least 1%–3% of its CDA, depending on the pond’s depth.

**Site Topography.** Ponds are best applied when the grade of contributing slopes is less than 15%.

**Available Hydraulic Head.** The depth of a pond is usually determined by the hydraulic head available on the site. The bottom elevation is normally the invert of the existing downstream conveyance system to which the pond discharges. Typically, a minimum of 6 to 8 feet of head are needed to hold the wet pool and any additional large storm storage or overflow capacity for a pond to function.

**Setbacks.** To avoid the risk of seepage, stormwater cannot flow via baseflow from stormwater ponds to a traditional pavement base layer, existing structure foundations, or an area where there may be future development adjacent to the property line. Setbacks to structures must be at least 10 feet and adequate waterproofing protection must be provided for foundations and basements. Where the 10-foot setback is not possible, an impermeable liner may be used along the sides of the practice, extending from the surface to the bottom of the practice.

**Proximity to Utilities.** For an open pond system, no utility lines shall be permitted to cross any part of the embankment of a wet pool.

**Depth to Water Table.** The depth to the groundwater table is not a major constraint for stormwater ponds because a high water table can help maintain wetland conditions. However, groundwater inputs can also reduce the pollutant removal rates of ponds. Further, if the water table is close to the surface, it may make excavation difficult and expensive.

**Soils.** Highly permeable soils will make it difficult to maintain a healthy permanent pool. Soil infiltration tests need to be conducted at proposed pond sites to determine the need for a pond liner or other method to ensure a constant water surface elevation. Underlying soils of HSG C or

D should be adequate to maintain a permanent pool. Most HSG A soils and some HSG B soils will require a liner (see Table 3-41). Geotechnical tests should be conducted to determine the saturated hydraulic conductivity and other subsurface properties of the soils beneath the proposed pond.

**Use of or Discharges to Natural Wetlands.** Ponds cannot be located within District waters, including wetlands, without obtaining a Section 404 permit or other permissions from the appropriate District or federal regulatory agency. In addition, the designer should investigate the wetland status of adjacent areas to determine if the discharge from the pond will change the hydroperiod of a downstream natural wetland (see Cappiella et al., 2006, for guidance on minimizing stormwater discharges to existing wetlands).

**Perennial Streams.** Locating ponds on perennial streams will require both a Section 401 and Section 404 permit or other permissions from the appropriate District or federal regulatory agency.

**Community and Environmental Concerns.** Ponds can generate the following community and environmental concerns that need to be addressed during design:

- **Aesthetic Issues.** Many residents feel that ponds are an attractive landscape feature, promote a greater sense of community and are an attractive habitat for fish and wildlife. Designers should note that these benefits are often diminished where ponds are under-sized or have small CDAs.
- **Existing Forests.** Construction of a pond may involve extensive clearing of existing forest cover. Designers can expect a great deal of neighborhood opposition if they do not make a concerted effort to save mature trees during pond design and construction. In the District of Columbia, a permit is required to remove a tree with a circumference greater than 44 inches on private lands. A permit is required to prune or remove any street tree between the sidewalk and the curb. These permits are issued by the District Department of Transportation, Urban Forestry Division (DDOT UFD).
- **Safety Risk.** Pond safety is an important community concern, since both young children and adults have perished by drowning in ponds through a variety of accidents, including falling through thin ice cover. Gentle side slopes and safety benches should be provided to avoid potentially dangerous drop-offs, especially where ponds are located near residential areas.
- **Pollutant Concerns.** Ponds collect and store water and sediment to increase residence time that will increase the likelihood for contaminated water and sediments to be neutralized. However, poorly sized, maintained, and/or functioning ponds can export contaminated sediments and/or water to receiving waterbodies (Mallin, 2000; Mallin et al., 2001; Messersmith, 2007). Further, designers are cautioned that recent research on ponds has shown that some ponds can be hotspots or incubators for algae that generate harmful algal blooms (HABs).
- **Mosquito Risk.** Mosquitoes are not a major problem for larger ponds (Santana et al., 1994; Ladd and Frankenburg, 2003; Hunt et al., 2005). However, fluctuating water levels in smaller

or under-sized ponds could pose some risk for mosquito breeding. Mosquito problems can be minimized through simple design features and maintenance operations described in MSSC (2005).

- Geese and Waterfowl. Ponds with extensive turf and shallow shorelines can attract nuisance populations of resident geese and other waterfowl, whose droppings add to the nutrient and bacteria loads, thus reducing the removal efficiency for those pollutants. Several design and landscaping features can make ponds much less attractive to geese (see Schueler, 1992).

### 3.10.2 Pond Conveyance Criteria

**Internal Slope.** The longitudinal slope of the pond bottom should be at least 0.5% to facilitate maintenance.

**Primary Spillway.** The spillway shall be designed with acceptable anti-flotation, anti-vortex and trash rack devices. The spillway must generally be accessible from dry land. When reinforced concrete pipe is used for the principal spillway to increase its longevity, “O-ring” gaskets (ASTM C361) shall be used to create watertight joints.

**Non-Clogging Low-Flow Orifice.** A low-flow orifice must be provided that is adequately protected from clogging by either an acceptable external trash rack or by internal orifice protection that may allow for smaller diameters. Orifices less than 3 inches in diameter may require extra attention during design to minimize the potential for clogging.

- One option is a submerged reverse-slope pipe that extends downward from the riser to an inflow point 1 foot below the normal pool elevation.
- Alternative methods must employ a broad crested rectangular V-notch (or proportional) weir, protected by a half-round CMP that extends at least 12 inches below the normal pool elevation.

**Emergency Spillway.** Ponds must be constructed with overflow capacity to pass the 100-year design storm event through either the primary spillway or a vegetated or armored emergency spillway unless waived by DOEE.

**Adequate Outfall Protection.** The design must specify an outfall that will be stable for the 15-year design storm event. The channel immediately below the pond outfall must be modified to prevent erosion and conform to natural dimensions in the shortest possible distance. This is typically done by placing appropriately sized riprap over geotextile fabric, which can reduce flow velocities from the principal spillway to non-erosive levels (3.5 to 5.0 feet per second) depending on the channel lining material. Flared pipe sections, which discharge at or near the stream invert or into a step pool arrangement, should be used at the spillway outlet.

When the discharge is to a manmade pipe or channel system, the system must be adequate to convey the required design storm peak discharge.

If a pond daylights to a channel with dry weather flow, care should be taken to minimize tree clearing along the downstream channel, and to reestablish a forested riparian zone in the shortest possible distance. Excessive use of riprap should be avoided.

The final release rate of the facility shall be modified if any increase in flooding or stream channel erosion would result at a downstream structure, highway, or natural point of restricted streamflow (see Section 2.11 Additional Stormwater Management Requirements).

**Inlet Protection.** Inflow points into the pond must be stabilized to ensure that non-erosive conditions exist during storm events up to the overbank flood event (i.e., the 15-year storm event). Inlet pipe inverts should generally be located at or slightly below the permanent pool elevation. A forebay shall be provided at each inflow location, unless the inlet is submerged or inflow provides less than 10% of the total design storm inflow to the pond.

**Dam Safety Permits.** The designer must verify whether or not Dam Safety permits or approvals are required for the embankment.

### 3.10.3 Pond Pretreatment Criteria

Sediment forebays are considered to be an integral design feature to maintain the longevity of all ponds. A forebay must be located at each major inlet to trap sediment and preserve the capacity of the main treatment cell. The following criteria apply to forebay design:

- A major inlet is defined as an individual storm drain inlet pipe or open channel serving at least 10% of the pond's CDA.
- The forebay consists of a separate cell, formed by an acceptable barrier (e.g., an earthen berm, concrete weir, gabion baskets, etc.).
- The forebay should be between 4 and 6 feet deep and must be equipped with a variable width aquatic bench for safety purposes. The aquatic bench should be 4 to 6 feet wide at a depth of 1 to 2 feet below the water surface. Small forebays may require alternate geometry to achieve the goals of pretreatment and safety within a small area.
- The forebay shall be sized to contain 0.1 inch of runoff from the contributing drainage impervious area. The relative size of individual forebays should be proportional to the percentage of the total inflow to the pond.
- The bottom of the forebay may be hardened (e.g., with concrete, asphalt, or grouted riprap) to make sediment removal easier.
- The forebay must be equipped with a metered rod in the center of the pool (as measured lengthwise along the low-flow water travel path) for long-term monitoring of sediment accumulation.
- Exit velocities from the forebay shall be non-erosive or an armored overflow shall be provided. Non-erosive velocities are 4 feet per second for the 2-year event, and 6 feet per second for the 15-year event.
- Direct maintenance access for appropriate equipment shall be provided to each forebay.

### 3.10.4 Pond Design Criteria

**Pond Storage Design.** The pond permanent pool must be sized to store a volume equivalent to the SWRV. Volume storage may be provided in multiple cells. Performance is enhanced when

multiple treatment pathways are provided by using multiple cells, longer flowpaths, high surface area to volume ratios, complex microtopography, and/or redundant treatment methods (combinations of pool, ED, and marsh).

**Pond Geometry.** Pond designs should have an irregular shape and a long flow path from inlet to outlet to increase water residence time and pond performance. The minimum length to width ratio (i.e., length relative to width) for ponds is 1.5:1. Greater flowpaths and irregular shapes are recommended. Internal berms, baffles, or vegetated peninsulas can be used to extend flow paths and/or create multiple pond cells.

**Permanent Pool Depth.** The maximum depth of the permanent pool should not generally exceed 8 feet unless the pond is designed for multiple uses.

**Micropool.** A micropool is a 3- to 6-foot-deep pool used to protect the low-flow pipe from clogging and to prevent sediment resuspension. For micropool extended detention ponds, the micropool shall be designed to hold at least 10%–25% of the 1.2-inch storm event.

**Side Slopes.** Side slopes for ponds should generally have a gradient no steeper than 3H:1V. Mild slopes promote better establishment and growth of vegetation and provide for easier maintenance and a more natural appearance.

**Maximum Extended Detention Levels.** The total storage, including any ponding for larger flooding events (100-year storm) should not extend more than 5 feet above the pond permanent pool unless specific design enhancements to ensure side slope stability, safety, and maintenance are identified and approved.

**Stormwater Pond Benches.** The perimeter of all pool areas greater than 4 feet in depth must be surrounded by two benches, as follows:

- **Safety Bench.** This is a flat bench located just outside of the perimeter of the permanent pool to allow for maintenance access and reduce safety risks. Except when the stormwater pond side slopes are 5H:1V or flatter, provide a safety bench that generally extends 8 to 15 feet outward from the normal water edge to the toe of the stormwater pond side slope. The maximum slope of the safety bench is 5%.
- **Aquatic Bench.** This is a shallow area just inside the perimeter of the normal pool that promotes growth of aquatic and wetland plants. The bench also serves as a safety feature, reduces shoreline erosion, and conceals floatable trash. Incorporate an aquatic bench that generally extends up to 10 feet inward from the normal shoreline, has an irregular configuration, and extends a maximum depth of 18 inches below the normal pool water surface elevation.

**Liners.** When a stormwater pond is located over highly permeable soils or fractured bedrock, a liner may be needed to sustain a permanent pool of water. If geotechnical tests confirm the need for a liner, acceptable options include the following: (1) a clay liner following the specifications outlined in Table 3-41; (2) a 30-mil- poly-liner; (3) bentonite; (4) use of chemical additives; or (5) an engineering design, as approved on a case-by-case basis by DOEE. A clay liner must have a minimum thickness of 12 inches with an additional 12-inch layer of compacted soil above it,

and it must meet the specifications outlined in Table 3-41. Other synthetic liners can be used if the designer can supply supporting documentation that the material will achieve the required performance.

**Table 3-41 Clay Liner Specifications**

Property	Test Method	Unit	Specification
Permeability	ASTM D2434	cm/s	$1 \times 10^{-6}$
Plasticity Index of Clay	ASTM D4318	%	Not less than 15
Liquid Limit of Clay	ASTM D2216	%	Not less than 30
Clay Particles Passing	ASTM D422	%	Not less than 30
Clay Compaction	ASTM D2216	%	95% of standard proctor density

Source: DCR (1999). VA

**Required Geotechnical Testing.** Soil borings must be taken below the proposed embankment, in the vicinity of the proposed outlet area, and in at least two locations within the proposed pond treatment area. Soil boring data is needed to (1) determine the physical characteristics of the excavated material, (2) determine its adequacy for use as structural fill or spoil, (3) provide data for structural designs of the outlet works (e.g., bearing capacity and buoyancy), (4) determine compaction/composition needs for the embankment, (5) determine the depth to groundwater and bedrock, and (6) evaluate potential infiltration losses (and the potential need for a liner).

**Non-clogging Low-Flow (Extended Detention) Orifice.** The low-flow ED orifice shall be adequately protected from clogging by an acceptable external trash rack. The preferred method is a submerged reverse-slope pipe that extends downward from the riser to an inflow point 1 foot below the normal pool elevation. Alternative methods are to employ a broad crested rectangular, V-notch, or proportional weir, protected by a half-round CMP that extends at least 12 inches below the normal pool.

**Riser in Embankment.** The riser should be located within the embankment for maintenance access, safety, and aesthetics. Access to the riser is to be provided by lockable manhole covers and manhole steps within easy reach of valves and other controls. The principal spillway opening can be "fenced" with pipe or rebar at 8-inch intervals for safety purposes.

**Trash Racks.** Trash racks shall be provided for low-flow pipes and for riser openings not having anti-vortex devices.

**Pond Drain.** Ponds should have a drainpipe that can completely or partially drain the permanent pool. In cases where a low-level drain is not feasible (such as in an excavated pond), a pump well must be provided to accommodate a temporary pump intake when needed to drain the pond.

- The drainpipe must have an upturned elbow or protected intake within the pond to help keep it clear of sediment deposition, and a diameter capable of draining the pond within 24 hours.
- The pond drain must be equipped with an adjustable valve located within the riser, where it will not be normally inundated and can be operated in a safe manner.

Care must be exercised during pond drawdowns to prevent downstream discharge of sediments or anoxic water and rapid drawdown. The approving authority shall be notified before draining a pond.

**Adjustable Gate Valve.** Both the outlet pipe and the pond drain must be equipped with an adjustable gate valve (typically a handwheel activated knife gate valve) or pump well and be sized one pipe size greater than the calculated design diameter. Valves must be located inside of the riser at a point where they will not normally be inundated and can be operated in a safe manner. To prevent vandalism, the handwheel should be chained to a ringbolt, manhole step, or other fixed object.

### **Safety Features.**

- The principal spillway opening must be designed and constructed to prevent access by small children.
- End walls above pipe outfalls greater than 48 inches in diameter must be fenced to prevent a falling hazard.
- Storage practices must incorporate an additional 1 foot of freeboard above the emergency spillway, or 2 feet of freeboard if design has no emergency spillway, for the maximum  $Q_f$  design storm unless more stringent Dam Safety requirements apply.
- The emergency spillway must be located so that downstream structures will not be impacted by spillway discharges.
- Both the safety bench and the aquatic bench should be landscaped with vegetation that hinders or prevents access to the pool.
- Warning signs prohibiting swimming must be posted.
- Where permitted, fencing of the perimeter of ponds is discouraged. The preferred method to reduce risk is to manage the contours of the stormwater pond to eliminate drop-offs or other safety hazards. Fencing is required at or above the maximum water surface elevation in the rare situations when the pond slope is a vertical wall.
- Side slopes to the pond shall not be steeper than 3H:1V, and shall terminate on a 15-foot-wide safety bench. Both the safety bench and the aquatic bench may be landscaped to prevent access to the pool. The bench requirement may be waived if slopes are 4H:1V or flatter.

**Maintenance Reduction Features.** Many maintenance issues can be addressed through well design access. All ponds must be designed for annual maintenance. Good access is needed so crews can remove sediments, make repairs, and preserve pond-treatment capacity. Design for the following,

- ◆ Adequate maintenance access must extend to the forebay, safety bench, riser, and outlet structure and must have sufficient area to allow vehicles to turn around.
- ◆ The riser should be located within the embankment for maintenance access, safety, and aesthetics. Access to the riser should be provided by lockable manhole covers and manhole steps within easy reach of valves and other controls.



- ◆ Access roads must (1) be constructed of load-bearing materials or be built to withstand the expected frequency of use, (2) have a minimum width of 15 feet, and (3) have a profile grade that does not exceed 5H:1V.
- ◆ A maintenance right-of-way or easement must extend to the stormwater pond from a public or private road.
- **Material Specifications.** ED ponds are generally constructed with materials obtained on site, except for the plant materials, inflow and outflow devices (e.g., piping and riser materials), possibly stone for inlet and outlet stabilization, and geotextile fabric for lining banks or berms.
- **Pond Sizing.** Stormwater ponds can be designed to capture and treat the remaining stormwater discharged from upstream practices from the design storm ( $SWR_v$ ). Additionally, stormwater ponds may be sized to control peak flow rates from the 2-year and 15-year frequency storm event or other design storms as required. Design calculations must ensure that the post-development peak discharge does not exceed the predevelopment peak discharge. See Section 2.10 Hydrology Methods for a summary of acceptable hydrologic methodologies and models.

For treatment train designs where upland practices are utilized for treatment of the  $SWR_v$ , designers can use a site-adjusted  $R_v$  or NRCS CN that reflects the volume reduction of upland practices to compute the  $Q_{p2}$  and  $Q_{p15}$  that must be treated by the stormwater pond.

The pond permanent pool must be sized to store a volume equivalent to the  $SWR_v$  or design volume.

The storage volume ( $S_v$ ) of the practice is equal to the volume provided by the pond permanent pool (Equation 3.25). The total  $S_v$  cannot exceed the design  $SWR_v$ .

### Equation 3.25 Pond Storage Volume

$$S_v = \text{Pond permanent pool volume}$$

- **Water Balance Testing.** A water balance calculation is recommended to document that sufficient inflows to wet ponds and wet ED ponds exist to compensate for combined infiltration and evapotranspiration losses during a 30-day summer drought without creating unacceptable drawdowns (see Equation 3.26, adapted from Hunt et al., 2007). The recommended minimum pool depth to avoid nuisance conditions may vary; however, it is generally recommended that the water balance maintain a minimum 24-inch reservoir.

**Equation 3.26 Water Balance Equation for Acceptable Water Depth in a Wet Pond**

$$DP > ET + INF + RES - MB$$

where:

<i>DP</i>	=	average design depth of the permanent pool (in.)
<i>ET</i>	=	summer evapotranspiration rate (in.) (assume 8 in.)
<i>INF</i>	=	monthly infiltration loss (assume 7.2 inches at 0.01 in./hour)
<i>RES</i>	=	reservoir of water for a factor of safety (assume 24 in.)
<i>MB</i>	=	measured baseflow rate to the pond, if any convert to pond-inches (in.)

Design factors that will alter this equation are the measurements of seasonal base flow and infiltration rate. The use of a liner could eliminate or greatly reduce the influence of infiltration. Similarly, land use changes in the upstream watershed could alter the base flow conditions over time (e.g., urbanization and increased impervious cover).

Translating the baseflow to inches refers to the depth within the pond. Therefore, Equation 3.27 can be used to convert the baseflow, measured in cubic feet per second (cfs), to pond-inches:

**Equation 3.27 Baseflow Conversion**

$$Pond - inches = \frac{MB \times 2.592 \times 10^6 \times 12}{SA}$$

where:

<i>Pond - inches</i>	=	depth within the pond (in.)
<i>MB</i>	=	measured baseflow rate to the pond (cfs)
$2.592 \times 10^6$	=	conversion factor, converting cfs to ft <sup>3</sup> /month
12	=	conversion factor, converting feet to inches
<i>SA</i>	=	surface area of pond (ft <sup>2</sup> )

**3.10.5 Pond Landscaping Criteria**

**Pond Benches.** The perimeter of all deep pool areas (4 feet or greater in depth) must be surrounded by two benches:

- A safety bench that extends 8 to 15 feet outward from the normal water edge to the toe of the pond side slope. The maximum slope of the safety bench shall be 6%.
- An aquatic bench that extends up to 10 feet inward from the normal shoreline and has a maximum depth of 18 inches below the normal pool water surface elevation.

**Landscaping and Planting Plan.** A landscaping plan must be provided that indicates the methods used to establish and maintain vegetative coverage in the pond and its buffer (see Section 3.6.5 Bioretention Landscaping Criteria for extended landscaping and planting details). Minimum elements of a landscaping plan include the following:

- Delineation of pondscaping zones within both the pond and buffer.
- Selection of corresponding plant species.
- The planting plan.
- The sequence for preparing the wetland benches (including soil amendments, if needed).
- Sources of native plant material.
- The landscaping plan should provide elements that promote diverse wildlife and waterfowl use within the stormwater wetland and buffers.
- Woody vegetation may not be planted or allowed to grow within 15 feet of the toe of the embankment nor within 25 feet from the principal spillway structure.
- A vegetated buffer should be provided that extends at least 25 feet outward from the maximum water surface elevation of the pond. Permanent structures (e.g., buildings) should not be constructed within the buffer area. Existing trees should be preserved in the buffer area during construction.
- The soils in the stormwater buffer area are often severely compacted during the construction process, to ensure stability. The density of these compacted soils can be so great that it effectively prevents root penetration and, therefore, may lead to premature mortality or loss of vigor. As a rule of thumb, planting holes should be three times deeper and wider than the diameter of the root ball for bare root and ball-and-burlap stock, and five times deeper and wider for container-grown stock.
- Avoid species that require full shade or are prone to wind damage. Extra mulching around the base of trees and shrubs is strongly recommended as a means of conserving moisture and suppressing weeds.

For more guidance on planting trees and shrubs in pond buffers, consult Cappiella et al. (2006).

### 3.10.6 Pond Construction Sequence

The following is a typical construction sequence to properly install a stormwater pond. The steps may be modified to reflect different pond designs; site conditions; and the size, complexity, and configuration of the proposed facility.

**Step 1: Use of Ponds for Soil Erosion and Sediment Control.** A pond may serve as a sediment basin during project construction. If this is done, the volume should be based on the more stringent sizing rule (soil erosion and sediment control requirement versus storage volume requirement). Installation of the permanent riser should be initiated during the construction phase, and design elevations should be set with final cleanout of the sediment basin and conversion to the post-construction pond in mind. The bottom elevation of the pond should be lower than the bottom elevation of the temporary sediment basin. Appropriate procedures must be implemented to prevent discharge of turbid waters when the basin is being converted into a pond.

Approval from DOEE must be obtained before any sediment pond can be used as for stormwater management.

**Step 2: Stabilize the Contributing Drainage Area.** Ponds should only be constructed after the CDA to the pond is completely stabilized. If the proposed pond site will be used as a sediment trap or basin during the construction phase, the construction notes should clearly indicate that the facility will be de-watered, dredged, and regraded to design dimensions after the original site construction is complete.

**Step 3: Assemble Construction Materials On Site.** Inspect construction materials to ensure they conform to design specifications and prepare any staging areas.

**Step 4: Clear and Strip.** Bring the project area to the desired subgrade.

**Step 5: Soil Erosion and Sediment Controls.** Install soil erosion and sediment control measures prior to construction, including temporary de-watering devices and stormwater diversion practices. All areas surrounding the pond that are graded or denuded during construction must be planted with turf grass, native plantings, or other approved methods of soil stabilization.

**Step 6: Excavate the Core Trench and Install the Spillway Pipe.**

**Step 7: Install the Riser or Outflow Structure.** Once riser and outflow structures are installed ensure the top invert of the overflow weir is constructed level at the design elevation.

**Step 8: Construct the Embankment and any Internal Berms.** These features must be installed in 8- to 12-inch lifts; compact the lifts with appropriate equipment.

**Step 9: Excavate and Grade.** Survey to achieve the appropriate elevation and designed contours for the bottom and side slopes of the pond.

**Step 10: Construct the Emergency Spillway.** The emergency spillway must be constructed in cut or structurally stabilized soils.

**Step 11: Install Outlet Pipes.** The installation of outlet pipes must include a downstream riprap protection apron.

**Step 12: Stabilize Exposed Soils.** Use temporary seed mixtures appropriate for the pond buffer to stabilize the exposed soils. All areas above the normal pool elevation must be permanently stabilized by hydroseeding or seeding over straw.

**Step 13: Plant the Pond Buffer Area.** Establish the planting areas according to the pondscaping plan (see Section 3.10.5 Pond Landscaping Criteria).

**Construction Supervision.** Supervision during construction is recommended to ensure that stormwater ponds are properly constructed, especially during the following stages of construction:

- Preconstruction meeting
- Initial site preparation including the installation of soil erosion and sediment control measures
- Excavation/Grading (interim and final elevations)
- Installation of the embankment, the riser/primary spillway, and the outlet structure
- Implementation of the pondscaping plan and vegetative stabilization

- Final inspection (develop a punch list for facility acceptance)

DOEE's construction phase inspection checklist for ponds can be found in Appendix L - Construction Inspection Checklists.

To facilitate maintenance, contractors should measure the actual constructed pond depth at three areas within the permanent pool (forebay, mid-pond and at the riser), and they should mark and geo-reference them on an as-built drawing. This simple data set will enable maintenance inspectors to determine pond sediment deposition rates in order to schedule sediment cleanouts.

### 3.10.7 Pond Maintenance Criteria

Maintenance is needed so stormwater ponds continue to operate as designed on a long-term basis. Ponds normally have fewer routine maintenance requirements than other stormwater control measures. Stormwater pond maintenance activities vary regarding the level of effort and expertise required to perform them. Routine stormwater pond maintenance, such as mowing and removing debris and trash, is needed several times each year (see Table 3-42). More significant maintenance (e.g., removing accumulated sediment) is needed less frequently but requires more skilled labor and special equipment. Inspection and repair of critical structural features (e.g., embankments and risers) needs to be performed by a qualified professional (e.g., a structural engineer) who has experience in the construction, inspection, and repair of these features.

Sediment removal in the pond pretreatment forebay should occur every 5 to 7 years or after 50% of total forebay capacity has been lost. The designer should also check to see whether removed sediments can be spoiled on site or must be hauled away. Sediments excavated from ponds are not usually considered toxic or hazardous. They can be safely disposed of by either land application or land filling. Sediment testing may be needed prior to sediment disposal if the pond serves a hotspot land use.

**Table 3-42 Pond Maintenance Tasks and Frequency**

Frequency	Maintenance Items
During establishment, as needed (first year)	<ul style="list-style-type: none"> <li>▪ Inspect the site at least twice after storm events that exceed a 1/2 inch of rainfall.</li> <li>▪ Plant the aquatic benches with emergent wetland species, following the planting recommendations contained in Section 3.11.6, "Stormwater Wetland Landscaping Criteria."</li> <li>▪ Stabilize any bare or eroding areas in the CDA or around the pond buffer.</li> <li>▪ Water trees and shrubs planted in the pond buffer during the first growing season. In general, consider watering every 3 days for first month, and then weekly during the remainder of the first growing season (April through October), depending on rainfall.</li> </ul>
Quarterly or after major storms (>1 inch of rainfall)	<ul style="list-style-type: none"> <li>▪ Mowing (twice a year)</li> <li>▪ Remove debris and blockages</li> <li>▪ Repair undercut, eroded, and bare soil areas</li> </ul>
Twice a year	<ul style="list-style-type: none"> <li>▪ Mowing of the buffer and pond embankment</li> </ul>

Frequency	Maintenance Items
Annually	<ul style="list-style-type: none"> <li>▪ Shoreline cleanup to remove trash, debris, and floatables</li> <li>▪ A full maintenance inspection</li> <li>▪ Open up the riser to access and test the valves</li> <li>▪ Repair broken mechanical components, if needed</li> </ul>
Once—during the second year following construction	<ul style="list-style-type: none"> <li>▪ Pond buffer and aquatic bench reinforcement plantings</li> </ul>
Every 5 to 7 years	<ul style="list-style-type: none"> <li>▪ Forebay sediment removal</li> </ul>
From 5 to 25 years	<ul style="list-style-type: none"> <li>▪ Repair pipes, the riser, and spillway, as needed</li> </ul>

**Maintenance Plans.** Maintenance plans must clearly outline how vegetation in the pond and its buffer will be managed or harvested in the future. Periodic mowing of the stormwater buffer is only required along maintenance rights-of-way and the embankment. The remaining buffer can be managed as a meadow (mowing every other year) or forest. The maintenance plan should schedule a shoreline cleanup at least once a year to remove trash and floatables.

**Maintenance Inspections.** Maintenance of a pond is driven by annual inspections by a qualified professional who evaluates the condition and performance of the pond. Based on inspection results, specific maintenance tasks will be triggered.

DOEE’s maintenance inspection checklist for stormwater ponds and the Maintenance Service Completion Inspection form can be found in Appendix M - Maintenance Inspection Checklists.

**Declaration of Covenants.** A declaration of covenants that includes all maintenance responsibilities to ensure the continued stormwater performance for the BMP is required. The declaration of covenants specifies the property owner’s primary maintenance responsibilities, and authorizes DOEE staff to access the property for inspection or corrective action in the event the proper maintenance is not performed. The declaration of covenants is recorded in the District of Columbia land records. A template form is provided at the end of Chapter 5 Administration of Stormwater Management Rules (see Figure 5.11), although variations will exist for scenarios where stormwater crosses property lines. The covenant is between the property and the Government of the District of Columbia. It is submitted through the Office of the Attorney General. All SWMPs have a maintenance agreement stamp that must be signed for a building permit to proceed. A maintenance schedule must appear on the SWMP. Additionally, a maintenance schedule is required in Exhibit C of the declaration of covenants.

Covenants are not required on government properties, but maintenance responsibilities must be defined through a partnership agreement or a memorandum of understanding.

**Waste Material.** Waste material from the repair, maintenance, or removal of a BMP or land cover shall be removed and disposed of in compliance with applicable federal and District law.

### 3.10.8 Pond Stormwater Compliance Calculations

Stormwater ponds receive 10% retention value and are an accepted total suspended solids (TSS) treatment practice for the amount of storage volume ( $S_v$ ) provided by the BMP (Table 3-43).

**Table 3-43 Pond Retention Value and Pollutant Removal**

Retention Value	$= 0.1 \times S_v$
Accepted TSS Treatment Practice	Yes

The resulting reduced runoff volumes can then be used to calculate a reduced NRCS CN for the site or SDA. The reduced NRCS CN can then be used to calculate peak flow rates for the various storm events. Other hydrologic modeling tools that employ different procedures may be used as well.

### 3.10.9 References

- ASTM C361-16, Standard Specification for Reinforced Concrete Low-Head Pressure Pipe, ASTM International, West Conshohocken, PA, 2016, [www.astm.org](http://www.astm.org)
- ASTM D2216-10, Standard Test Methods for Laboratory Determination of Water (Moisture) Content of Soil and Rock by Mass, ASTM International, West Conshohocken, PA, 2010, [www.astm.org](http://www.astm.org)
- ASTM D2434-68(2006), Standard Test Method for Permeability of Granular Soils (Constant Head) (Withdrawn 2015), ASTM International, West Conshohocken, PA, 2006, [www.astm.org](http://www.astm.org)
- ASTM D4318-17, Standard Test Methods for Liquid Limit, Plastic Limit, and Plasticity Index of Soils, ASTM International, West Conshohocken, PA, 2017, [www.astm.org](http://www.astm.org)
- ASTM D422-63(2007)e2, Standard Test Method for Particle-Size Analysis of Soils (Withdrawn 2016), ASTM International, West Conshohocken, PA, 2007, [www.astm.org](http://www.astm.org)
- Cappiella, K., T. Schueler and T. Wright. 2006. Urban Watershed Forestry Manual: Part 2: Conserving and Planting Trees at Development Sites. USDA Forest Service. Center for Watershed Protection. Ellicott City, MD.
- Hunt, W., C. Apperson, and W. Lord. 2005. "Mosquito Control for Stormwater Facilities." Urban Waterways. North Carolina State University and North Carolina Cooperative Extension. Raleigh, NC.
- Hunt, W., M. Burchell, J. Wright and K. Bass. 2007. "Stormwater Wetland Design Update: Zones, Vegetation, Soil and Outlet Guidance." Urban Waterways. North Carolina State Cooperative Extension Service. Raleigh, NC.
- Ladd, B and J. Frankenburg. 2003. Management of Ponds, Wetlands and Other Water Reservoirs. Purdue Extension. WQ-41-W.

- Mallin, M. 2000. Effect of human development on bacteriological water quality in coastal watersheds. *Ecological Applications* 10(4):1047-1056.
- Mallin, M.A., S.H. Ensign, Matthew R. McIver, G. Christopher Shank, and Patricia K. Fowler. 2001. Demographic, landscape, and meteorological factors controlling the microbial pollution of coastal waters. *Hydrobiologia* 460(1-3):185-193.
- Messersmith, M.J. 2007. Assessing the hydrology and pollutant removal efficiencies of wet detention ponds in South Carolina. MS. Charleston, S.C. College of Charleston, Master of Environmental Studies.
- Minnesota Stormwater Steering Committee (MSSC). 2005. *Minnesota Stormwater Manual*. Emmons & Oliver Resources, Inc. Minnesota Pollution Control Agency. St. Paul, MN.
- Santana, F., J. Wood, R. Parsons, and S. Chamberlain. 1994. *Control of Mosquito Breeding in Permitted Stormwater Systems*. Southwest Florida Water Management District. Brooksville, FL.
- Schueler, T, 1992. *Design of Stormwater Wetland Systems*. Metropolitan Washington Council of Governments. Washington, DC.
- Virginia Department of Conservation and Recreation (VA DCR). 1999. *Virginia Stormwater Management Handbook*, first edition.
- Virginia DCR Stormwater Design Specification No. 14: Wet Ponds Version 1.8. 2010.
- Virginia DCR Stormwater Design Specification No. 15: Extended Detention (ED) Pond Version 1.8. 2010.
- VA Department of Conservation and Recreation (VA DCR). 1999. *Virginia Stormwater Management Handbook*, first edition.



### 3.11 Stormwater Wetlands

**Definition.** Practices that create shallow marsh areas to treat urban stormwater, which often incorporate small permanent pools and/or extended detention storage. Stormwater wetlands are explicitly designed to provide stormwater detention for larger storms (2-year, 15-year, or flood control events) above the design storm (SWR<sub>v</sub>) storage. Design variants include the following:

W-1 Shallow wetland

W-2 Extended detention shallow wetland

Stormwater wetlands, sometimes called constructed wetlands, are shallow depressions that receive stormwater inputs for water quality treatment. Wetlands are typically less than 1 foot deep (although they have greater depths at the forebay and in micropools) and possess variable microtopography to promote dense and diverse wetland cover. Runoff from each new storm displaces runoff from previous storms, and the long residence time allows multiple pollutant removal processes to operate. The wetland environment provides an ideal environment for gravitational settling, biological uptake, and microbial activity. Several stormwater wetland design features are illustrated in Figure 3.41 through Figure 3.43.

Stormwater wetlands should be considered for use after all other upland retention opportunities have been exhausted and there is still a remaining treatment volume or runoff from larger storms (i.e., 2-year, 15-year or flood control events) to manage.

Stormwater wetlands receive only 10% of the storage volume as retention volume and should be considered mainly for management of larger storm events. Stormwater wetlands have both community and environmental concerns (see Section 3.11.1 Stormwater Wetland Feasibility Criteria) that should be considered before choosing stormwater ponds for the appropriate stormwater practice on site.

Note: All of the pond performance criteria presented in Section 3.10, “Ponds” also apply to the design of stormwater wetlands. Additional criteria that govern the geometry and establishment of created wetlands are presented in this section.

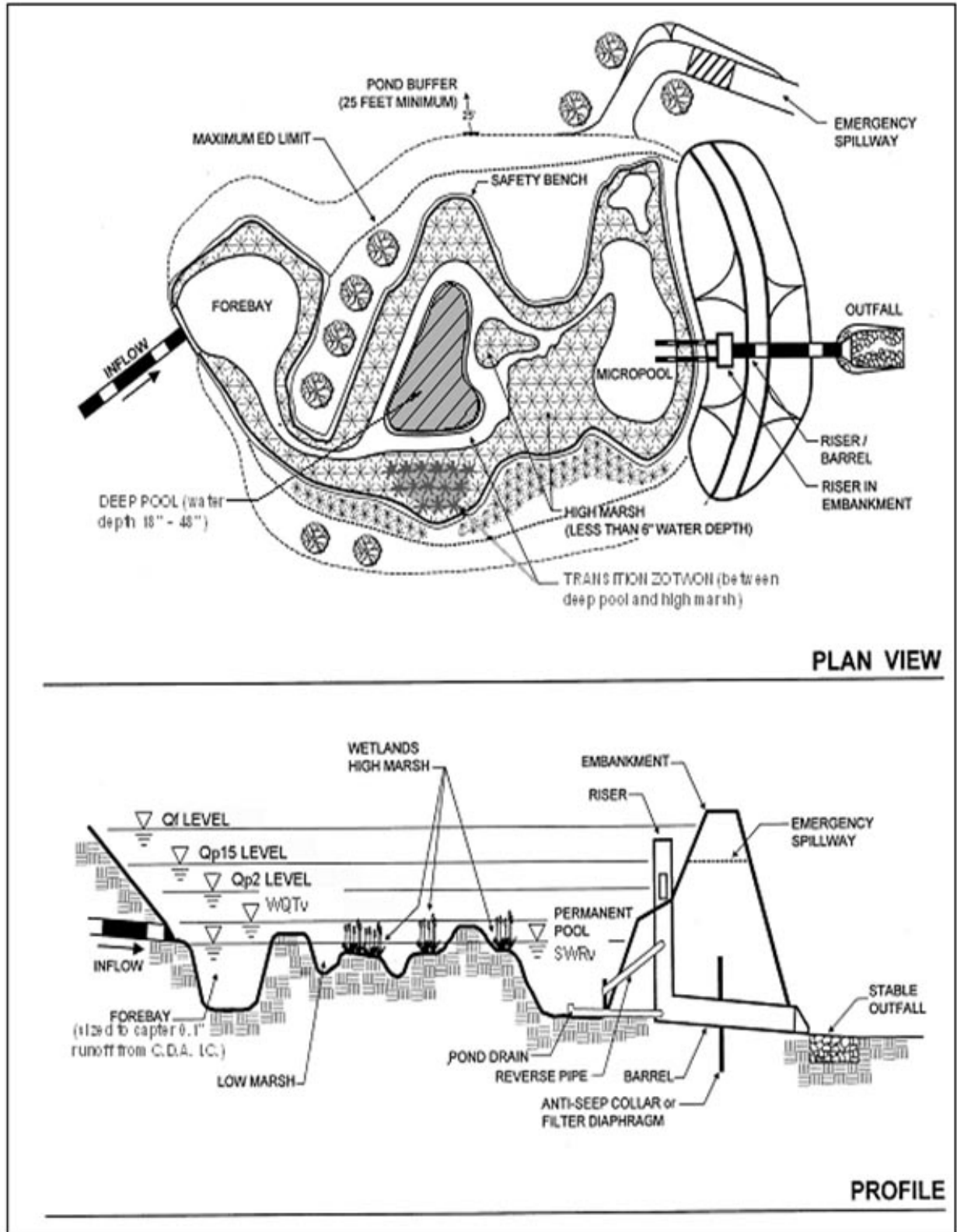


Figure 3.41 Example of extended detention shallow wetland.

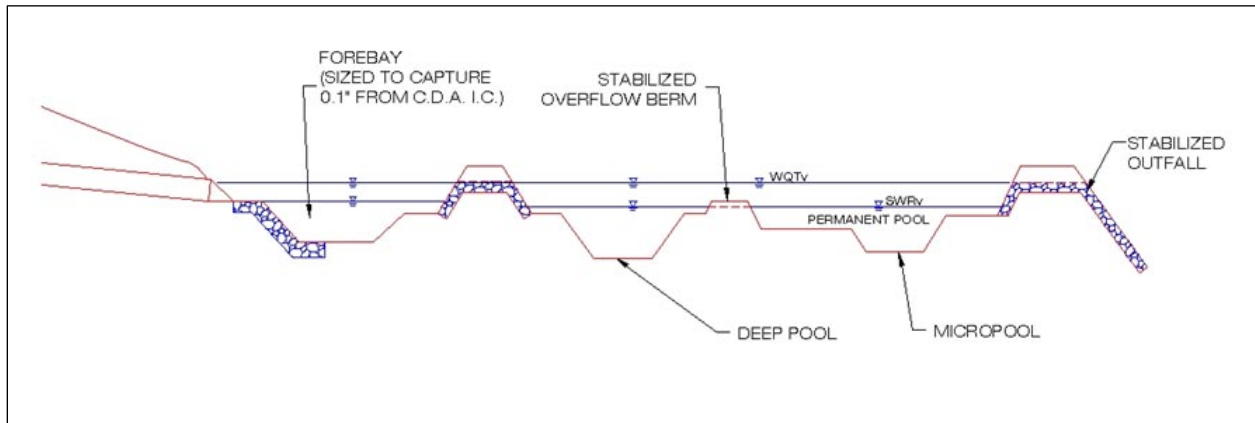


Figure 3.42 Cross section of a typical stormwater wetland.

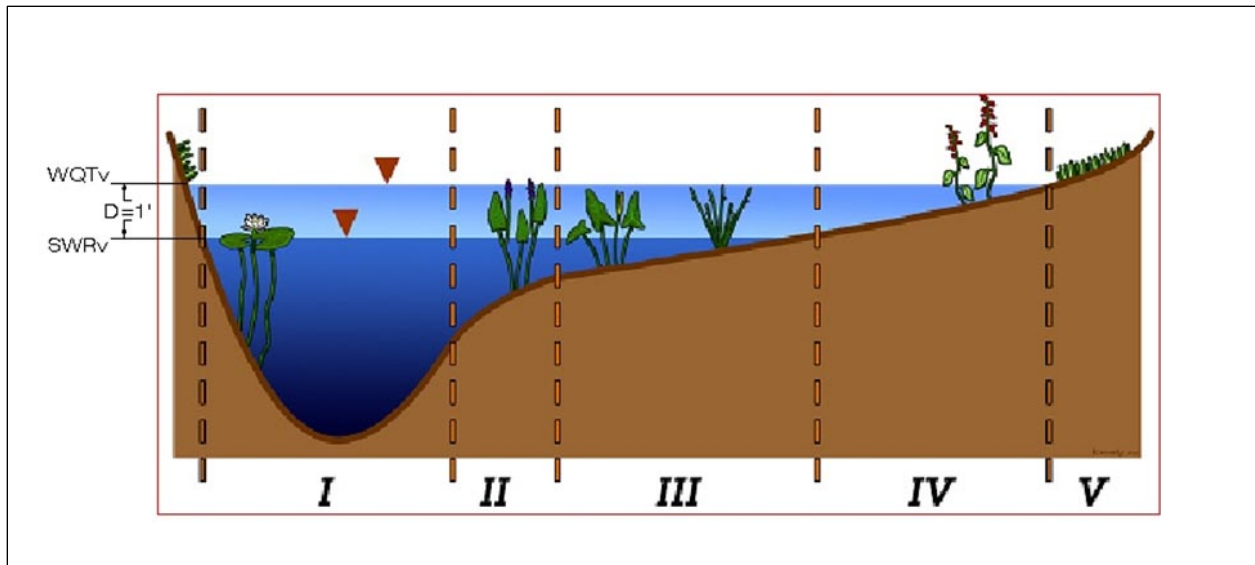


Figure 3.43 Interior wetland zones: (I) Deep Pool (depth -48 to -18 inches), (II) Transition Zone (depth -18 to -6 inches), (III and IV) High Marsh Zone (depth -6 to +6 inches), (IV) Temporary Inundation Area, and (V) Upper Bank (adapted from Hunt et al., 2007).

### 3.11.1 Stormwater Wetland Feasibility Criteria

Constructed wetland designs are subject to the following site constraints:

**Adequate Water Balance.** Stormwater wetlands must have enough water supplied from groundwater, runoff, or baseflow so that the permanent pools will not draw down by more than 2 feet after a 30-day summer drought. A simple water balance calculation must be performed using the equation provided in Section 3.11.4, “Stormwater Wetland Design Criteria.”

**Contributing Drainage Area.** The CDA must be large enough to sustain a permanent water level within the stormwater wetland. If the only source of wetland hydrology is stormwater runoff, then several dozen acres of CDA are typically needed to maintain constant water elevations. Smaller CDAs are acceptable if the bottom of the stormwater wetland intercepts the groundwater table or if the designer or approving agency is willing to accept periodic wetland drawdown.

**Space Requirements.** Constructed wetlands normally require a footprint that takes up about 3% of the CDA, depending on the average depth of the wetland and the extent of its deep pool features.

**Site Topography.** Stormwater wetlands are best applied when the grade of contributing slopes is less than 8%.

**Steep Slopes.** A modification of the constructed wetland (and linear wetland or wet swale system) is the regenerative stormwater conveyance (RSC) or step pool storm conveyance channel. The RSC can be used to bring stormwater down steeper grades through a series of step pools. This can serve to bring stormwater down outfalls where steep drops on the edge of the tidal receiving system can create design challenges. For more information on RSC systems, designers can consult the Anne Arundel County Design Specifications, available at <http://www.aacounty.org/departments/public-works/wprp/watershed-assessment-and-planning/step-pool-conveyance-systems/index.html>

**Available Hydraulic Head.** The depth of a constructed wetland is usually constrained by the hydraulic head available on the site. The bottom elevation is fixed by the elevation of the existing downstream conveyance system to which the wetland will ultimately discharge. Because constructed wetlands are typically shallow, the amount of head needed (usually a minimum of 2 to 4 feet) is typically less than for wet ponds.

**Setbacks.** To avoid the risk of seepage, stormwater cannot flow via baseflow from stormwater wetlands to the traditional pavement base layer, existing structure foundations, or an area where there may be future development adjacent to the property line. Setbacks to structures and property lines must be at least 10 feet and adequate waterproofing protection must be provided for foundations and basements. Where the 10-foot setback is not possible, an impermeable liner may be used along the sides of the practice, extending from the surface to the bottom of the practice.

**Depth to Water Table.** The depth to the groundwater table is not a major constraint for constructed wetlands, since a high water table can help maintain wetland conditions. However, designers should keep in mind that high groundwater inputs may increase excavation costs (refer to Section 3.10 Ponds).

**Soils.** Soil tests should be conducted to determine the saturated hydraulic conductivity and other subsurface properties of the soils underlying the proposed stormwater wetland. Highly permeable soils will make it difficult to maintain a healthy permanent pool. Underlying soils of HSG C or D should be adequate to maintain a permanent pool. Most HSG A soils and some HSG B soils will require a liner (see Table 3-41).

**Use of or Discharges to Natural Wetlands.** Constructed wetlands may not be located within jurisdictional waters, including wetlands, without obtaining a Section 404 permit from the appropriate federal regulatory agency. In addition, designer should investigate the status of adjacent wetlands to determine if the discharge from the constructed wetland will change the hydroperiod of a downstream natural wetland. See Cappiella et al. (2006) for guidance on minimizing stormwater discharges to existing wetlands.

**Regulatory Status.** Constructed wetlands built for the express purpose of stormwater treatment are generally not considered jurisdictional wetlands.

**Perennial Streams.** Locating a constructed wetland along or within a perennial stream will require both Section 401 and Section 404 permits from the state or federal regulatory authority.

**Community and Environmental Concerns.** In addition to the community and environmental concerns that exist for stormwater ponds, the following must be addressed during design of stormwater wetlands:

- **Aesthetics and Habitat.** Constructed wetlands can create wildlife habitat and can also become an attractive community feature. Designers should think carefully about how the wetland plant community will evolve over time, since the future plant community seldom resembles the one initially planted.
- **Existing Forests.** Given the large footprint of a constructed wetland, there is a strong chance that the construction process may result in extensive tree clearing. The designer should preserve mature trees during the facility layout, and he/she may consider creating a wooded wetland (see Cappiella et al., 2006). In the District of Columbia, a permit is required to remove a tree with a circumference greater than 44 inches on private lands. A permit is required to prune or remove any street tree between the sidewalk and the curb. These permits are issued DDOT UFD.
- **Safety Risk.** Constructed wetlands are safer than other types of ponds, although forebays and micropools must be designed with aquatic benches to reduce safety risks.
- **Mosquito Risk.** Mosquito control can be a concern for stormwater wetlands if they are under-sized or have a small CDA. Deepwater zones serve to keep mosquito populations in check by providing habitat for fish and other pond life that prey on mosquito larvae. Few mosquito problems are reported for well-designed, properly sized, and frequently maintained constructed wetlands; however, no design can eliminate them completely. Simple precautions can be taken to minimize mosquito breeding habitat within constructed wetlands (e.g., constant inflows, benches that create habitat for natural predators, and constant pool elevations—MSSC, 2005).

### 3.11.2 Stormwater Wetland Conveyance Criteria

- The slope profile within individual stormwater wetland cells should generally be flat from inlet to outlet (adjusting for microtopography). The recommended maximum elevation drop between wetland cells is 1 foot or less.
- Since most constructed wetlands are on-line facilities, they need to be designed to safely pass the maximum design storm (e.g., the 15-year and 100-year design storms). While the ponding depths for the more frequent 2-year storm are limited in order to avoid adverse impacts to the planting pallet, the overflow for the less frequent 15- and 100-year storms must likewise be carefully designed to minimize the depth of ponding. A maximum depth of 4 feet over the wetland pool is recommended.
- While many options are available for setting the normal pool elevation, it is strongly recommended that removable flashboard risers be used, given their greater operational flexibility to adjust water levels following construction (see Hunt et al., 2007). Also, a weir can be designed to accommodate passage of the larger storm flows at relatively low ponding depths.

### 3.11.3 Stormwater Wetland Pretreatment Criteria

Sediment regulation is critical to sustain stormwater wetlands. Consequently, a forebay shall be located at the inlet and a micropool shall be located at the outlet. A micropool is a 3- to 6-foot-deep pool used to protect the low-flow pipe from clogging and to prevent sediment resuspension. Forebays are designed in the same manner as stormwater ponds (see Section 3.10.3 Pond Pretreatment Criteria). The design of forebays should consider the possibility of heavy trash loads from public areas.

### 3.11.4 Stormwater Wetland Design Criteria

**Internal Design Geometry.** Research and experience have shown that the internal design geometry and depth zones are critical in maintaining the pollutant removal capability and plant diversity of stormwater wetlands. Stormwater wetland performance is enhanced when the wetland has multiple cells, longer flowpaths, and a high ratio of surface area to volume. Whenever possible, constructed wetlands should be irregularly shaped with long, sinuous flow paths. The following design elements are required for stormwater wetlands:

**Multiple-Cell Wetlands.** Stormwater wetlands can be divided into at least four internal sub-cells of different elevations: the forebay, a micro-pool outlet, and two additional cells. Cells can be formed by sand berms (anchored by rock at each end), back-filled coir fiber logs, or forested peninsulas (extending as wedges across 95% of the wetland width). The vegetative target is to ultimately achieve a 50-50 mix of emergent and forested wetland vegetation within all four cells.

The first cell (the forebay) is deeper and is used to receive runoff from the pond cell or the inflow from a pipe or open channel and distribute it as sheetflow into successive wetland cells. The surface elevation of the second cell is the normal pool elevation. It may contain a forested island or a sand wedge channel to promote flows into the third cell, which is 3 to 6 inches lower than the normal pool elevation. The purpose of the wetland cells is to create an alternating sequence of aerobic and anaerobic conditions to maximize pollutant removal. The fourth wetland cell is located at the discharge point and serves as a micro-pool with an outlet structure or weir.

**Extended Detention Ponding Depth.** When extended detention is provided for management of larger storm events, the total ED volume shall not comprise more than 50% of the total volume stored by the stormwater wetland, and its maximum water surface elevation shall not extend more than 3 feet above the normal pool.

**Deep Pools.** Approximately 25% of the stormwater surface area must be provided in at least three deeper pools—located at the inlet (forebay), center, and outlet (micropool) of the wetland—with each pool having a depth of from 18 to 48 inches. Refer to the sizing based on water balance below for additional guidance on the minimum depth of the deep pools.

**High Marsh Zone.** Approximately 70% of the stormwater wetland surface area must exist in the high marsh zone (-6 inches to +6 inches, relative to the normal pool elevation).

**Transition Zone.** The low marsh zone is no longer an acceptable wetland zone, and is only allowed as a short transition zone from the deeper pools to the high marsh zone (-6 to -18 inches below the normal pool elevation). In general, this transition zone should have a maximum slope of 5H:1V (or preferably flatter) from the deep pool to the high marsh zone. It is advisable to install biodegradable erosion control fabrics or similar materials during construction to prevent erosion or slumping of this transition zone.

**Flow Path.** In terms of the flow path, there are two design objectives:

- The overall flow path through the stormwater wetland can be represented as the length-to-width ratio OR the flow path ratio. A minimum overall flow path of 2:1 must be provided across the stormwater wetland.
- The shortest flow path represents the distance from the closest inlet to the outlet. The ratio of the shortest flow path to the overall length must be at least 0.5. In some cases—due to site geometry, storm sewer infrastructure, or other factors—some inlets may not be able to meet these ratios. However, the CDA served by these “closer” inlets must constitute no more than 20% of the total CDA.

**Side Slopes.** Side slopes for the stormwater wetland should generally have gradients of 4H:1V or flatter. These mild slopes promote better establishment and growth of the wetland vegetation. They also contribute to easier maintenance and a more natural appearance.

**Micro-Topographic Features.** Stormwater wetlands must have internal structures that create variable micro-topography, which is defined as a mix of above-pool vegetation, shallow pools, and deep pools that promote dense and diverse vegetative cover.

**Stormwater Wetland Material Specifications.** Stormwater wetlands are generally constructed with materials obtained on site, except for the plant materials, inflow and outflow devices (e.g., piping and riser materials), possibly stone for inlet and outlet stabilization, and geotextile fabric for lining banks or berms. Plant stock should be nursery grown, unless otherwise approved, and must be healthy and vigorous native species free from defects, decay, disfiguring roots, sun-scald, injuries, abrasions, diseases, insects, pests, and all forms of infestations or objectionable disfigurements, as determined by DOEE.

**Stormwater Wetland Sizing.** Stormwater wetlands can be designed to capture and treat the remaining stormwater discharged from upstream practices from the design storm (SWR<sub>v</sub>). Additionally, stormwater wetlands can be sized to control peak flow rates from the 2-year and 15-year frequency storm event or other design storm. Design calculations must ensure that the post-development peak discharge does not exceed the predevelopment peak discharge. See Section 2.10 Hydrology Methods for a summary of acceptable hydrologic methodologies and models.

For treatment train designs where upland practices are utilized for treatment of the SWR<sub>v</sub>, designers can use a site-adjusted R<sub>v</sub> or NRCS CN that reflects the volume reduction of upland practices to compute the Q<sub>p2</sub> and Q<sub>p15</sub> that must be treated by the stormwater wetland.

The wetland permanent pools (volume stored in deep pools and pool depths) must be sized to store a volume equivalent to the SWR<sub>v</sub> or design volume.

The storage volume (S<sub>v</sub>) of the practice is equal to the volume provided by the wetland permanent pool (Equation 3.28). The total S<sub>v</sub> cannot exceed the SWR<sub>v</sub>.

#### Equation 3.28 Stormwater Wetland Storage Volume

$$S_v = \text{Stormwater wetland permanent pool volume}$$

**Sizing for Minimum Pool Depth.** Initially, it is recommended that there be no minimum CDA requirement for the system, although it may be necessary to calculate a water balance for the wet pond cell when its CDA is less than 10 acres (Refer to Section 3.10 Ponds).

Similarly, if the hydrology for the constructed wetland is not supplied by groundwater or dry weather flow inputs, a simple water balance calculation must be performed, using Equation 3.29 (Hunt et al., 2007), to assure the deep pools will not go completely dry during a 30-day summer drought.

#### Equation 3.29 Water Balance for Acceptable Water Depth in a Stormwater Wetland

$$DP = \left( RF_m \times EF \times \frac{WS}{WL} \right) - (ET - INF - RES)$$

where:

<i>DP</i>	=	depth of pool (in.)
<i>RF<sub>m</sub></i>	=	monthly rainfall during drought (in.)
<i>EF</i>	=	fraction of rainfall that enters the stormwater wetland (in.) (CDA × R <sub>v</sub> )
<i>WS/WL</i>	=	ratio of contributing drainage area to stormwater wetland surface area
<i>ET</i>	=	summer evapotranspiration rate (in.) (assume 8 in.)
<i>INF</i>	=	monthly infiltration loss (assume 7.2 inches at 0.01 in./hr)
<i>RES</i>	=	reservoir of water for a factor of safety (assume 6 in.)



Using Equation 3.30, setting the groundwater and (dry weather) base flow to zero and assuming a worst-case summer rainfall of 0 inches, the minimum depth of the pool is calculated as follows (Equation 3.30):

**Equation 3.30 Minimum Depth of the Permanent Pool**

$$DP = RF_m - ET - INF - RES = -21.2$$

where:

<i>DP</i>	=	depth of pool (in.)
<i>RF<sub>m</sub></i>	=	monthly rainfall during drought (in.)
<i>ET</i>	=	summer evapotranspiration rate (in.) (assume 8 in.)
<i>INF</i>	=	monthly infiltration loss (assume 7.2 inches at 0.01 in./hr)
<i>RES</i>	=	reservoir of water for a factor of safety (assume 6 in.)

Therefore, unless there is other input, such as base flow or groundwater, the minimum depth of the pool should be at least 21.2 inches (rather than the 18-inch minimum depth noted in this section).

**3.11.5 Stormwater Wetland Construction Sequence**

The construction sequence for stormwater wetlands depends on-site conditions, design complexity, and the size and configuration of the proposed facility. The following two-stage construction sequence is recommended for installing an on-line stormwater wetland facility and establishing vigorous plant cover.

**Stage 1 Construction Sequence: Wetland Facility Construction.**

**Step 1: Stabilize Contributing Drainage Area.** Stormwater wetlands should only be constructed after the CDA to the wetland is completely stabilized. If the proposed stormwater wetland site will be used as a sediment trap or basin during the construction phase, the construction notes must clearly indicate that the facility will be de-watered, dredged, and re-graded to design dimensions after the original site construction is complete.

**Step 2: Assemble Construction Materials On Site.** Inspect construction materials to ensure they conform to design specifications and prepare any staging areas.

**Step 3: Clear and Strip.** Bring the project area to the desired subgrade.

**Step 4: Install Soil Erosion and Sediment Control Measures.** Prior to construction, including sediment basins and stormwater diversion practices. All areas surrounding the stormwater wetland that are graded or denuded during construction of the wetland are to be planted with turf grass, native plant materials, or other approved methods of soil stabilization. Grass sod is preferred over seed to reduce seed colonization of the stormwater wetland. During construction, the stormwater wetland must be separated from the CDA so that no sediment flows into the wetland areas. In some cases, a phased or staged soil erosion and sediment control plan

may be necessary to divert flow around the stormwater wetland area until installation and stabilization are complete.

**Step 5: Excavate the Core Trench for the Embankment and Install the Spillway Pipe.**

**Step 6: Install the Riser or Outflow Structure** and ensure that the top invert of the overflow weir is constructed level and at the proper design elevation (flashboard risers are strongly recommended by Hunt et al., 2007).

**Step 7: Construct the Embankment and any Internal Berms** in 8- to 12-inch lifts and compact them with appropriate equipment.

**Step 8: Excavate and Grade.** Survey to achieve the appropriate elevation and designed contours for the bottom and side slopes of the stormwater wetland. This is normally done by “roughing up” the interim elevations with a skid loader or other similar equipment to achieve the desired topography across the wetland. Spot surveys should be made to ensure that the interim elevations are 3 to 6 inches below the final elevations for the wetland.

**Step 9: Install Micro-Topographic Features and Soil Amendments** within the stormwater wetland area. Since most stormwater wetlands are excavated to deep sub-soils, they often lack the nutrients and organic matter needed to support vigorous growth of wetland plants. It is therefore essential to add sand, compost, topsoil, or wetland mulch to all depth zones in the stormwater wetland. The importance of soil amendments in excavated stormwater wetlands cannot be over-emphasized; poor survival and future wetland coverage are likely if soil amendments are not added. The planting soil should be a high organic content loam or sandy loam, placed by mechanical methods, and spread by hand. Planting soil depth should be at least 4 inches for shallow wetlands. No machinery should be allowed to traverse over the planting soil during or after construction. Planting soil should be tamped as directed in the design specifications, but it should not be overly compacted. After the planting soil is placed, it should be saturated and allowed to settle for at least one week prior to installation of plant materials.

**Step 10: Construct the Emergency Spillway** in cut or structurally stabilized soils.

**Step 11: Install Outlet Pipes.** The installation of outlet pipes must include a downstream riprap protection apron.

**Step 12: Stabilize Exposed Soils** with temporary seed mixtures appropriate for a wetland environment. All wetland features above the normal pool elevation should be temporarily stabilized by hydro-seeding or seeding over straw.

## **Stage 2 Construction Sequence: Establishing the Wetland Vegetation.**

**Step 13: Finalize the Stormwater Wetland Landscaping Plan.** At this stage the engineer, landscape architect, and wetland expert work jointly to refine the initial wetland landscaping plan after the stormwater wetland has been constructed. Several weeks of standing time is needed so that the designer can more precisely predict the following:

- Where the inundation zones are located in and around the stormwater wetland; and
- Whether the final grade and wetland microtopography will persist over time.

This allows the designer to select appropriate species and additional soil amendments, based on field confirmation of soils properties and the actual depths and inundation frequencies occurring within the stormwater wetland.

**Step 14: Open Up the Stormwater Wetland Connection.** Once the final grades are attained, the pond and/or CDA connection should be opened to allow the wetland cell to fill up to the normal pool elevation. Gradually inundate the stormwater wetland to avoid erosion of unplanted features. Inundation must occur in stages so that deep pool and high marsh plant materials can be placed effectively and safely. Wetland planting areas should be at least partially inundated during planting to promote plant survivability.

**Step 15: Measure and Stake Planting Depths** at the onset of the planting season. Depths in the stormwater wetland should be measured to the nearest inch to confirm the original planting depths of the planting zone. At this time, it may be necessary to modify the plan to reflect altered depths or a change in the availability of wetland plant stock. Surveyed planting zones should be marked on the as-built or design plan, and their locations should also be identified in the field, using stakes or flags.

**Step 16: Propagate the Stormwater Wetland.** Two techniques are used in combination to propagate the emergent community over the wetland bed:

- 1. Initial Planting of Container-Grown Wetland Plant Stock.** The transplanting window extends from early April to mid-June. Planting after these dates can decrease the chance of survival, since emergent wetland plants need a full growing season to build the root reserves needed to get through the winter. It is recommended that plants be ordered at least 6 months in advance to ensure the availability and on-time delivery of desired species.
- 2. Broadcasting Wetland Seed Mixes.** The higher wetland elevations should be established by broadcasting wetland seed mixes to establish diverse emergent wetlands. Seeding of switchgrass or wetland seed mixes as a ground cover is recommended for all zones above 3 inches below the normal pool elevation. Hand broadcasting or hydroseeding can be used to spread seed, depending on the size of the wetland cell.

**Step 17: Install Goose Protection to Protect Newly Planted or Newly Growing Vegetation.** This is particularly critical for newly established emergents and herbaceous plants, as predation by Canada geese can quickly decimate wetland vegetation. Goose protection can consist of netting, webbing, or string installed in a crisscross pattern over the surface area of the stormwater wetland, above the level of the emergent plants.

**Step 18: Plant the Stormwater Wetland Fringe and Buffer Area.** This zone generally extends from 1 to 3 feet above the normal pool elevation (from the shoreline fringe to about half of the maximum water surface elevation for the 2-year storm). Consequently, plants in this zone are infrequently inundated (5 to 10 times per year), and must be able to tolerate both wet and dry periods.

**Construction Supervision.** Supervision during construction is recommended to ensure that stormwater wetlands are properly constructed and established. Multiple site visits and inspections by a qualified professional are recommended during the following stages of the stormwater wetland construction process:

- Preconstruction meeting
- Initial site preparation including the installation of project soil erosion and sediment control measures
- Excavation/grading (e.g., interim/final elevations)
- Wetland installation (e.g., microtopography, soil amendments, and staking of planting zones)
- Planting phase (with an experienced landscape architect or wetland expert)
- Final inspection (develop a punch list for facility acceptance)

DOEE's construction phase inspection checklist for Stormwater Wetlands can be found in Appendix L - Construction Inspection Checklists.

### 3.11.6 Stormwater Wetland Landscaping Criteria

An initial stormwater wetland landscaping plan is required for any stormwater wetland and should be jointly developed by the engineer and a wetlands expert or experienced landscape architect. The plan should outline a detailed schedule for the care, maintenance, and possible reinforcement of vegetation in the wetland and its buffer for up to 10 years after the original planting.

The plan should outline a realistic, long-term planting strategy to establish and maintain desired wetland vegetation. The plan should indicate how wetland plants will be established within each inundation zone (e.g., wetland plants, seed-mixes, volunteer colonization, and tree and shrub stock) and whether soil amendments are needed to get plants started. At a minimum, the plan should contain the following:

- Plan view(s) with topography at a contour interval of no more than 1 foot and spot elevations throughout the cell showing the stormwater wetland configuration, different planting zones (e.g., high marsh, deep water, upland), microtopography, grades, site preparation, and construction sequence.
- A plant schedule and planting plan specifying emergent, perennial, shrub and tree species, quantity of each species, stock size, type of root stock to be installed, and spacing. To the degree possible, the species list for the constructed wetland should contain plants found in similar local wetlands.

The following general guidance is provided:

- **Use Native Species Where Possible.** Table 3.46 provides a list of common native shrub and tree species and Table 3.47 provides a list of common native emergent, submergent, and perimeter plant species, all of which have proven to do well in stormwater wetlands in the mid-Atlantic region and are generally available from most commercial nurseries (consult DOEE's webpage for information on area suppliers). Other native species can be used that appear in state-wide plant lists. The use of native species is strongly encouraged, but in some cases, non-native ornamental species may be added as long as they are not invasive. Invasive species such as cattails, Phragmites, and purple loosestrife must not be planted.

- **Match Plants to Inundation Zones.** The various plant species shown in Table 3-44 and Table 3-45 should be matched to the appropriate inundation zone. The first four inundation zones are particularly applicable to stormwater wetlands, as follows:

**Zone 1** -6 inches to -12 inches below the normal pool elevation

**Zone 2** -6 inches to the normal pool elevation

**Zone 3** From the normal pool elevation to +12 inches above

**Zone 4** +12 inches to +36 inches above the normal pool elevation (i.e., above ED Zone)

Note: The Low Marsh Zone (-6 to -18 inches below the normal pool elevation) has been dropped since experience has shown that few emergent wetland plants flourish in this deeper zone.

- **Aggressive Colonizers.** To add diversity to the stormwater wetland, five to seven species of emergent wetland plants should be planted, using at least four emergent species designated as aggressive colonizers (shown in bold in Table 3-45). No more than 25% of the high marsh wetland surface area needs to be planted. If the appropriate planting depths are achieved, the entire stormwater wetland should be colonized within 3 years. Individual plants should be planted 18 inches on center within each single species “cluster.”

**Table 3-44 Popular, Versatile, and Available Native Trees and Shrubs for Stormwater Wetlands**

Shrubs		Trees	
Common and Scientific Names	Zone <sup>1</sup>	Common and Scientific Names	Zone <sup>1</sup>
Button Bush ( <i>Cephalanthus occidentalis</i> )	2, 3	Atlantic White Cedar ( <i>Chamaecyparis thyoides</i> )	2, 3
Common Winterberry ( <i>Ilex verticillata</i> )	3, 4	Bald Cypress ( <i>Taxodium distichum</i> )	2, 3
Elderberry ( <i>Sambucus canadensis</i> )	3	Black Willow ( <i>Salix nigra</i> )	3, 4
Indigo Bush ( <i>Amorpha fruticosa</i> )	3	Box Elder ( <i>Acer Negundo</i> )	2, 3
Inkberry ( <i>Ilex glabra</i> )	2, 3	Green Ash ( <i>Fraxinus pennsylvanica</i> )	3, 4
Smooth Alder ( <i>Alnus serrulata</i> )	2, 3	Grey Birch ( <i>Betula populifolia</i> )	3, 4
Spicebush ( <i>Lindera benzoin</i> )	3, 4	Red Maple ( <i>Acer rubrum</i> )	3, 4
Swamp Azalea ( <i>Azalea viscosum</i> )	2, 3	River Birch ( <i>Betula nigra</i> )	3, 4
Swamp Rose ( <i>Rosa palustris</i> )	2, 3	Swamp Tupelo ( <i>Nyssa biflora</i> )	2, 3
Sweet Pepperbush ( <i>Clethra ainifolia</i> )	2, 3	Sweetbay Magnolia ( <i>Magnolia virginiana</i> )	3, 4
		Sweetgum ( <i>Liquidambar styraciflua</i> )	3, 4
		Sycamore ( <i>Platanus occidentalis</i> )	3, 4
		Water Oak ( <i>Quercus nigra</i> )	3, 4
		Willow Oak	3,4

Shrubs		Trees	
Common and Scientific Names	Zone <sup>1</sup>	Common and Scientific Names	Zone <sup>1</sup>
		( <i>Quercus phellos</i> )	

<sup>1</sup>Zone 1: -6 to -12 inches below the normal pool elevation

Zone 2: -6 inches to the normal pool elevation

Zone 3: From the normal pool elevation to +12 inches

Zone 4: +12 to +36 inches; above ED zone

Source: Virginia DCR Stormwater Design Specification No. 13: Constructed Wetlands Version 1.8. 2010.

**Table 3-45 Popular, Versatile, and Available Native Emergent and Submergent Vegetation for Stormwater Wetlands**

Plant	Zone <sup>1</sup>	Form	Inundation Tolerance	Wildlife Value	Notes
Arrow Arum ( <i>Peltandra virginica</i> )	2	Emergent	Up to 1 ft	High; berries are eaten by wood ducks	Full sun to partial shade
<b>Broad-Leaf Arrowhead (Duck Potato)</b> ( <i>Sagittaria latifolia</i> )	2	Emergent	Up to 1 ft	Moderate; tubers and seeds eaten by ducks	Aggressive colonizer
Blueflag Iris* ( <i>Iris versicolor</i> )	2, 3	Emergent	Up to 6 in.	Limited	Full sun (to flower) to partial shade
Broomsedge ( <i>Andropogon virginianus</i> )	2, 3	Perimeter	Up to 3 in.	High; songbirds and browsers; winter food and cover	Tolerant of fluctuating water levels and partial shade
<b>Bulltongue Arrowhead</b> ( <i>Sagittaria lancifolia</i> )	2, 3	Emergent	0 to 24 in.	Waterfowl, small mammals	Full sun to partial shade
<b>Burreed</b> ( <i>Sparganium americanum</i> )	2, 3	Emergent	0 to 6 in.	Waterfowl, small mammals	Full sun to partial shade
Cardinal Flower * ( <i>Lobelia cardinalis</i> )	3	Perimeter	Periodic inundation	Attracts hummingbirds	Full sun to partial shade
<b>Common Rush</b> ( <i>Juncus spp.</i> )	2, 3	Emergent	Up to 12 in.	Moderate; small mammals, waterfowl, songbirds	Full sun to partial shade
<b>Common Three Square</b> ( <i>Scirpus pungens</i> )	2	Emergent	Up to 6 in.	High; seeds, cover, waterfowl, songbirds	Fast colonizer; can tolerate periods of dryness; full sun; high metal removal
Duckweed ( <i>Lemna sp.</i> )	1, 2	Submergent / Emergent	Yes	High; food for waterfowl and fish	May biomagnify metals beyond concentrations found in the water
Joe Pye Weed ( <i>Eupatorium purpureum</i> )	2, 3	Emergent	Drier than other Joe-Pye Weeds; dry to moist areas; periodic inundation	Butterflies, songbirds, insects	Tolerates all light conditions
<b>Lizard's Tail</b> ( <i>Saururus cernus</i> )	2	Emergent	Up to 1 ft	Low; except for wood ducks	Rapid growth; shade-tolerant

Plant	Zone <sup>1</sup>	Form	Inundation Tolerance	Wildlife Value	Notes
Marsh Hibiscus ( <i>Hibiscus moscheutos</i> )	2, 3	Emergent	Up to 3 in.	Low; nectar	Full sun; can tolerate periodic dryness
<b>Pickeralweed</b> ( <i>Pontederia cordata</i> )	2, 3	Emergent	Up to 1 ft	Moderate; ducks, nectar for butterflies	Full sun to partial shade
Pond Weed ( <i>Potamogeton pectinatus</i> )	1	Submergent	Yes	Extremely high; waterfowl, marsh and shore birds	Removes heavy metals from the water
Rice Cutgrass ( <i>Leersia oryzoides</i> )	2, 3	Emergent	Up to 3 in.	High; food and cover	Prefers full sun, although tolerant of shade; shoreline stabilization
<b>Sedges</b> ( <i>Carex spp.</i> )	2, 3	Emergent	Up to 3 in.	High; waterfowl, songbirds	Wetland and upland species
<b>Softstem Bulrush</b> ( <i>Scirpus validus</i> )	2, 3	Emergent	Up to 2 ft	Moderate; good cover and food	Full sun; aggressive colonizer; high pollutant removal
<b>Smartweed</b> ( <i>Polygonum spp.</i> )	2	Emergent	Up to 1 ft	High; waterfowl, songbirds; seeds and cover	Fast colonizer; avoid weedy aliens, such as <i>P. Perfoliatum</i>
<b>Spatterdock</b> ( <i>Nuphar luteum</i> )	2	Emergent	Up to 1.5 ft	Moderate for food, but High for cover	Fast colonizer; tolerant of varying water levels
Switchgrass ( <i>Panicum virgatum</i> )	2, 3, 4	Perimeter	Up to 3 in.	High; seeds, cover; waterfowl, songbirds	Tolerates wet/dry conditions
Sweet Flag * ( <i>Acorus calamus</i> )	2, 3	Perimeter	Up to 3 in.	Low; tolerant of dry periods	Tolerates acidic conditions; not a rapid colonizer
Waterweed ( <i>Elodea canadensis</i> )	1	Submergent	Yes	Low	Good water oxygenator; high nutrient, copper, manganese, and chromium removal
Wild celery ( <i>Valisneria americana</i> )	1	Submergent	Yes	High; food for waterfowl; habitat for fish and invertebrates	Tolerant of murky water and high nutrient loads
Wild Rice ( <i>Zizania aquatica</i> )	2	Emergent	Up to 1 ft	High; food, birds	Prefers full sun
<b>Woolgrass</b> ( <i>Scirpus cyperinus</i> )	3, 4	Emergent	Yes	High: waterfowl, small mammals	Fresh tidal and non-tidal, swamps, forested wetlands, meadows, ditches

<sup>1</sup>Zone 1: -6 to -12 inches below the normal pool elevation

Zone 2: -6 inches to the normal pool elevation

Zone 3: From the normal pool elevation to +12 inches

Zone 4: +12 to +36 inches; above ED zone

\*Not a major colonizer, but adds color (Aggressive colonizers are shown in **bold** type.)

Source: Virginia DCR Stormwater Design Specification No. 13: Constructed Wetlands Version 1.8. 2010.

- **Suitable Tree Species.** The major shift in stormwater wetland design is to integrate trees and shrubs into the design, in tree islands, peninsulas, and fringe buffer areas. Deeper-rooted trees and shrubs that can extend to the stormwater wetland's local water table are important for creating a mixed wetland community. Table 3-44 above presents some recommended tree and shrub species in the mid-Atlantic region for different inundation zones. A good planting strategy includes varying the size and age of the plant stock to promote a diverse structure. Using locally grown container or bare root stock is usually the most successful approach if planting in the spring. It is recommended that buffer planting areas be over-planted with a small stock of fast growing successional species to achieve quick canopy closure and shade out invasive plant species. Trees may be planted in clusters to share rooting space on compacted wetland side-slopes. Planting holes should be amended with compost (a 2:1 ratio of loose soil to compost) prior to planting.
- **Pre- and Post-Nursery Care.** Plants should be kept in containers of water or moist coverings to protect their root systems and keep them moist when in transporting them to the planting location. As much as 6 to 9 months of lead time may be needed to fill orders for wetland plant stock from aquatic plant nurseries. Consult DOEE's webpage for information on area suppliers.

### 3.11.7 Stormwater Wetland Maintenance Criteria

Successful establishment of constructed wetland areas requires that the following tasks be undertaken in the first 2 years:

- **Initial Inspections.** During the first 6 months following construction, the site should be inspected by a qualified professional at least twice after storm events that exceed 0.5 inch of rainfall.
- **Spot Reseeding.** Inspections should include looking for bare or eroding areas in the CDA or around the wetland buffer, and make sure they are immediately stabilized with grass cover.
- **Watering.** Trees planted in the buffer and on wetland islands and peninsulas need watering during the first growing season. In general, consider watering every 3 days for first month, and then weekly during the first growing season (April through October), depending on rainfall.
- **Reinforcement Plantings.** Regardless of the care taken during the initial planting of the stormwater wetland and buffer, it is probable that some areas will remain unvegetated and some species will not survive. Poor survival can result from many unforeseen factors, such as predation, poor quality plant stock, water level changes, and drought. Thus, it is advisable to budget for an additional round of reinforcement planting after one or two growing seasons. Construction contracts should include a care and replacement warranty extending at least two growing seasons after initial planting, to selectively replant portions of the stormwater wetland that fail to fill in or survive. If a minimum coverage of 50% is not achieved in the planted wetland zones after the second growing season, a reinforcement planting will be required.

Managing vegetation is an important ongoing maintenance task at every constructed wetland and for each inundation zone. Following the design criteria above should result in a reduced need for



regular mowing of the embankment and access roads. Vegetation within the stormwater wetland, however, will require some annual maintenance.

Designers should expect significant changes in wetland species composition to occur over time. Inspections should carefully track changes in wetland plant species distribution over time. Invasive plants should be dealt with as soon as they begin to colonize the stormwater wetland. As a general rule, control of undesirable invasive species (e.g., cattails and Phragmites) should commence when their coverage exceeds more than 15% of a wetland cell area. Although the application of herbicides is not recommended, some types (e.g., Glyphosate) have been used to control cattails with some success. Extended periods of dewatering may also work, since early manual removal provides only short-term relief from invasive species. While it is difficult to exclude invasive species completely from stormwater wetlands, their ability to take over the entire wetland can be reduced if the designer creates a wide range of depth zones and a complex internal structure within the wetland.

Thinning or harvesting of excess forest growth may be periodically needed to guide the forested stormwater wetland into a more mature state. Vegetation may need to be harvested periodically if the constructed wetland becomes overgrown. Thinning or harvesting operations should be scheduled to occur approximately 5 and 10 years after the initial stormwater wetland construction. Removal of woody species on or near the embankment and maintenance access areas should be conducted every 2 years.

Designers should refer to Section 3.10.7 Pond Maintenance Criteria for additional maintenance responsibilities associated with stormwater wetlands. Ideally, maintenance of constructed wetlands should be driven by annual inspections by a qualified professional that evaluates the condition and performance of the stormwater wetland. Based on inspection results, specific maintenance tasks will be triggered. DOEE's maintenance inspection checklist for stormwater wetlands and the Maintenance Service Completion Inspection form can be found in Appendix M - Maintenance Inspection Checklists.

**Declaration of Covenants.** A declaration of covenants that includes all maintenance responsibilities to ensure the continued stormwater performance for the BMP is required. The declaration of covenants specifies the property owner's primary maintenance responsibilities, and authorizes DOEE staff to access the property for inspection or corrective action in the event the proper maintenance is not performed. The declaration of covenants is recorded in the District of Columbia land records. A template form is provided at the end of Chapter 5 Administration of Stormwater Management Rules (see Figure 5.11), although variations will exist for scenarios where stormwater crosses property lines. The covenant is between the property owner and the Government of the District of Columbia. It is submitted through the Office of the Attorney General. All SWMPs have a maintenance agreement stamp that must be signed for a building permit to proceed. A maintenance schedule must appear on the SWMP. Additionally, a maintenance schedule is required in Exhibit C of the declaration of covenants.

Covenants are not required on government properties, but maintenance responsibilities must be defined through a partnership agreement or a memorandum of understanding.

**Waste Material.** Waste material from the repair, maintenance, or removal of a BMP or land cover shall be removed and disposed of in compliance with applicable federal and District law.

### 3.11.8 Stormwater Wetland Stormwater Compliance Calculations

Stormwater wetlands receive 10% retention value and are an accepted total suspended solids (TSS) treatment practice for the amount of storage volume (Sv) provided by the BMP (Table 3-46).

**Table 3-46 Stormwater Wetland Retention Value and Pollutant Removal**

Retention Value	= $0.1 \times Sv$
Accepted TSS Treatment Practice	Yes

The retention achieved by stormwater wetlands also contributes to peak flow reduction. This contribution can be determined in several ways. One method is to subtract the retention value from the total runoff volume for the 2-year, 15-year, and 100-year storms. The resulting reduced runoff volumes can then be used to calculate a reduced NRCS CN for the site or SDA. The reduced NRCS CN can then be used to calculate peak flow rates for the various storm events. Other hydrologic modeling tools that employ different procedures may be used as well.

### 3.11.9 References

- Cappiella, K., T. Schueler and T. Wright. 2006. Urban Watershed Forestry Manual: Part 2: Conserving and Planting Trees at Development Sites. USDA Forest Service. Center for Watershed Protection. Ellicott City, MD.
- Hunt, W., M. Burchell, J. Wright and K. Bass. 2007. “Stormwater Wetland Design Update: Zones, Vegetation, Soil and Outlet Guidance.” Urban Waterways. North Carolina State Cooperative Extension Service. Raleigh, NC.
- Minnesota Stormwater Steering Committee (MSSC). 2005. Minnesota Stormwater Manual. Emmons & Oliver Resources, Inc. Minnesota Pollution Control Agency. St. Paul, MN.
- Virginia DCR Stormwater Design Specification No. 13: Constructed Wetlands Version 1.8. 2010.

## 3.12 Storage Practices

**Definition.** Storage practices are explicitly designed to provide stormwater detention (2-year, 15-year, and/or flood control). Design variants include the following:

- S-1 Underground detention vaults and tanks
- S-2 Dry detention ponds
- S-3 Rooftop storage
- S-4 Stone storage under permeable pavement or other BMPs

Detention vaults are box-shaped underground stormwater storage facilities typically constructed with reinforced concrete. Detention tanks are underground storage facilities typically constructed with large diameter metal or plastic pipe (see Figure 3.44). Both serve as an alternative to surface dry detention for stormwater quantity control, particularly for space-limited areas where there is not adequate land for a dry detention basin or multi-purpose detention area. Prefabricated concrete vaults are available from commercial vendors. In addition, several pipe manufacturers have developed packaged detention systems.

Dry detention ponds are widely applicable for most land uses and are best suited for larger SDAs. An outlet structure restricts stormwater flow so it backs up and is stored within the basin (see Figure 3.45). The temporary ponding reduces the maximum peak discharge to the downstream channel, thereby reducing the effective shear stress on the bed and banks of the receiving stream.

Storage practices do not receive any stormwater retention or treatment volume and should be considered only for management of larger storm events. Storage practices are not considered an acceptable practice to meet the SWRv. Storage practices must be combined with a separate facility to meet these requirements. Upland practices can be used to satisfy some or all of the stormwater retention requirements at many sites, which can help to reduce the footprint and volume of storage practices.

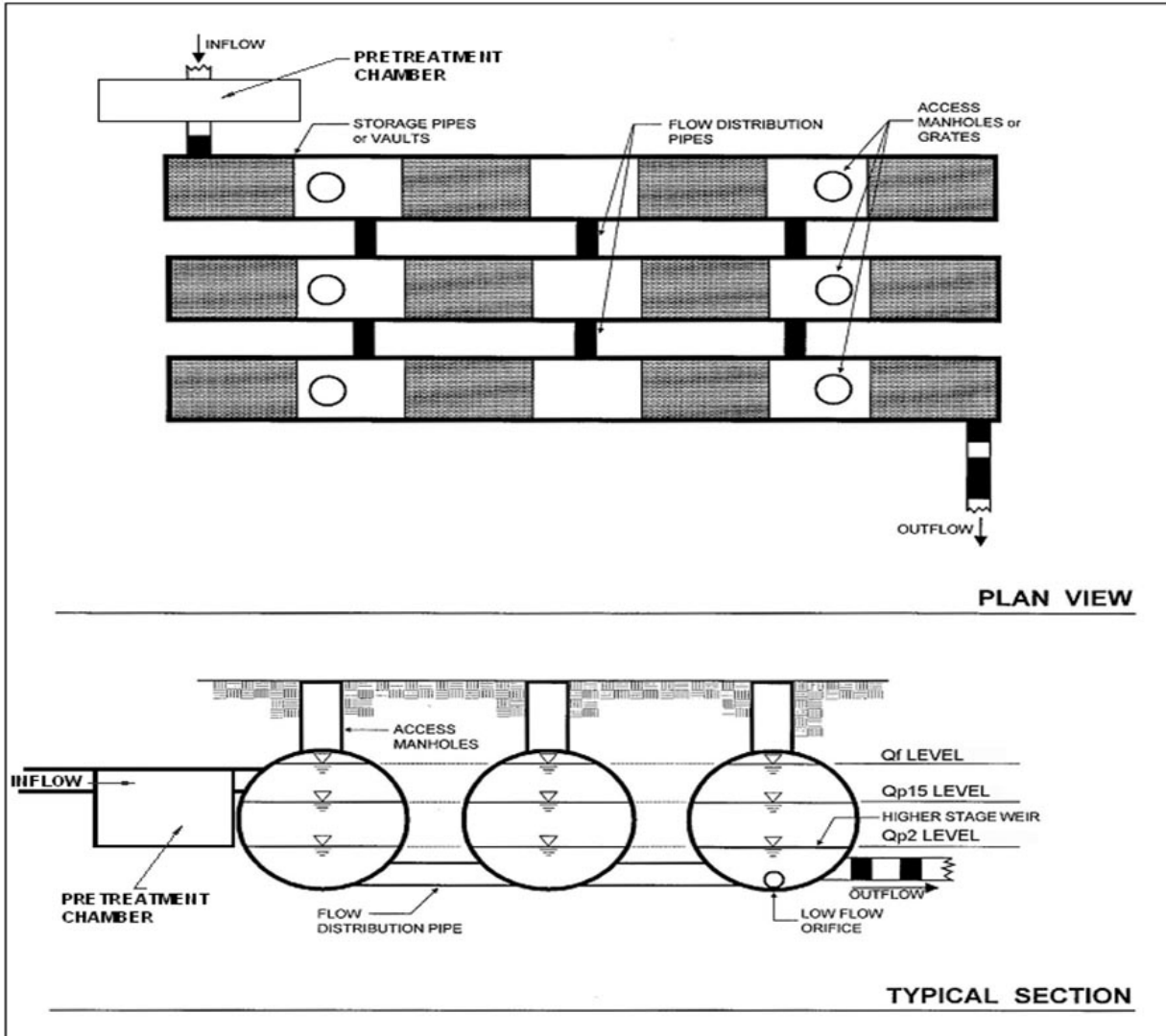


Figure 3.44 Example of an underground detention vault and/or tank (S-1).

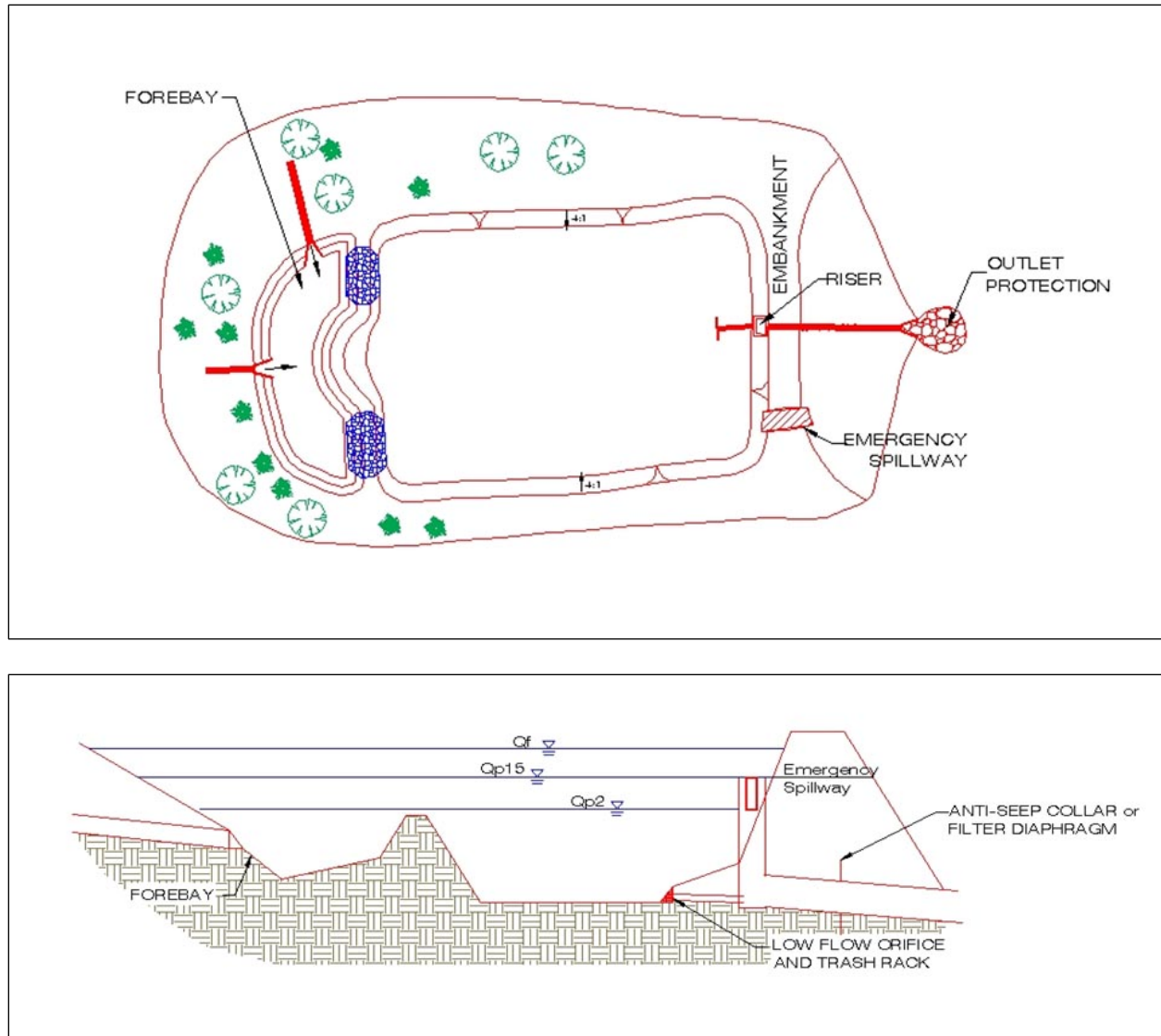


Figure 3.45 Example of a dry detention pond (S-2).

### 3.12.1 Storage Feasibility Criteria

The following feasibility issues need to be evaluated when storage practices are considered as the final practice in a treatment train:

**Space Required.** A typical storage practice requires a footprint of 1%–3% of its CDA, depending on the depth of the pond or storage vault (i.e., the deeper the practice, the smaller footprint needed).

**Contributing Drainage Area.** A CDA of at least 10 acres is preferred for dry ponds in order to keep the required orifice size from becoming a maintenance problem. Designers should be aware that small “pocket” ponds will typically (1) have very small orifices that will be prone to

clogging, (2) experience fluctuating water levels such that proper stabilization with vegetation is very difficult, and (3) generate more significant maintenance problems.

Underground detention systems can be located downstream of other structural stormwater controls providing treatment of the design storm. For treatment train designs where upland practices are utilized for treatment of the SWR<sub>v</sub>, designers can use a site-adjusted R<sub>v</sub> or NRCS CN that reflects the volume reduction of upland practices and likely reduce the size and cost of detention (see Storage Practice Sizing in Section 3.12.4, “Storage Design Criteria”).

The maximum CDA to be served by a single underground detention vault or tank is 25 acres.

**Available Hydraulic Head.** The depth of a storage practice is usually determined by the amount of hydraulic head available at the site (dimension between the surface drainage and the bottom elevation of the site). The bottom elevation is normally the invert of the existing downstream conveyance system to which the storage practice discharges. Depending on the size of the development and the available surface area of the basin, as much as 6 to 8 feet of hydraulic head may be needed for a dry detention practice to function properly for storage. An underground storage practice will require sufficient head room to facilitate maintenance—at least 5 feet depending on the design configuration.

**Setbacks.** To avoid the risk of seepage, stormwater cannot flow via baseflow from storage practices to the traditional pavement base layer, existing structure foundations, or an area where there may be future development adjacent to the property line. Setbacks to structures and property lines must be at least 10 feet, and adequate waterproofing protection must be provided for foundations and basements. Where the 10-foot setback is not possible, an impermeable liner may be used along the sides of the practice, extending from the surface to the bottom of the practice.

**Depth to Water Table and Bedrock.** Dry ponds are not allowed if the water table or bedrock will be within 2 feet of the floor of the pond. For underground detention vaults and tanks, an anti-flotation analysis is required to check for buoyancy problems in high water table areas.

**Soils.** The permeability of soils is seldom a design constraint for storage practices. Soil infiltration tests should be conducted at proposed dry pond sites to estimate infiltration rates and patterns, which can be significant in HSG A soils and some group B soils. Infiltration through the bottom of the pond is typically encouraged unless it may potentially migrate laterally through a soil layer and impair the integrity of the embankment or other structure.

**Structural Stability.** Underground detention vaults and tanks must meet structural requirements for overburden support and traffic loading if appropriate as verified by shop drawings signed by an appropriately licensed professional.

**Geotechnical Tests.** At least one soil boring must be taken at a low point within the footprint of any proposed storage practice to establish the water table and bedrock elevations and evaluate soil suitability. A geotechnical investigation is required for all underground BMPs, including underground storage systems. Geotechnical testing requirements are outlined in Appendix P - Geotechnical Information Requirements for Underground BMPs.

**Utilities.** For a dry pond system, no utility lines shall be permitted to cross any part of the embankment where the design water depth is greater than 2 feet. Typically, utilities require a minimum 5-foot horizontal clearance from storage facilities.

**Perennial Streams.** Locating dry ponds on perennial streams will require both a Section 401 and Section 404 permit from the appropriate District or federal regulatory agency.

### 3.12.2 Storage Conveyance Criteria

Designers must use accepted hydrologic and hydraulic routing calculations to determine the required storage volume and an appropriate outlet design for storage practices. See Section 2.10 Hydrology Methods for a summary of acceptable hydrologic methodologies and models.

For management of the 2-year storm, a control structure with a trash rack designed to release the required predevelopment  $Q_{p2}$  must be provided. Ideally, the channel protection orifice should have a minimum diameter of 3 inches in order to pass minor trash and debris. However, where smaller orifices are required, the orifice must be adequately protected from clogging by an acceptable external trash rack.

As an alternative, the orifice diameter may be reduced if internal orifice protection is used (i.e., a perforated vertical stand pipe with 0.5-inch orifices or slots that are protected by wirecloth and a stone filtering jacket). Adjustable gate valves, weir manholes, and other structures designed for simple maintenance can also be used to achieve this equivalent diameter.

For overbank flood protection, an additional outlet is sized for  $Q_{p15}$  control and can consist of a weir, orifice, outlet pipe, combination outlet, or other acceptable control structure.

Riprap, plunge pools or pads, or other energy dissipators are to be placed at the end of the outlet to prevent scouring and erosion and to provide a non-erosive velocity of flow from the structure to a water course. The design must specify an outfall that will be stable for the 15-year design storm event. The channel immediately below the storage practice outfall must be modified to prevent erosion. This is typically done by calculating channel velocities and flow depths, then placing appropriately sized riprap, over geotextile fabric, which can reduce flow velocities from the principal spillway to non-erosive levels (3.5 to 5.0 feet per second depending on the channel lining material). The storage practice geometry and outfall design may need to be altered in order to yield adequate channel velocities and flow.

Flared pipe sections that discharge at or near the stream invert or into a step pool arrangement should be used at the spillway outlet. An outfall analysis shall be included in the SWMP showing discharge velocities down to the nearest downstream water course. Where indicated, the developer or contractor must secure an off-site drainage easement for any improvements to the downstream channel.

When the discharge is to a manmade pipe or channel system, the system must be adequate to convey the required design storm peak discharge.

If discharge daylight to a channel with dry weather flow, care should be taken to minimize tree clearing along the downstream channel, and to reestablish a forested riparian zone in the shortest possible distance. Excessive use of riprap should be avoided.

The final release rate of the facility shall be modified if any increase in flooding or stream channel erosion would result at a downstream structure, highway, or natural point of restricted streamflow (see Section 2.11 Additional Stormwater Management Requirements).

The following additional conveyance criteria apply to underground detention or ponds:

- **High Flow Bypass (underground detention).** An internal or external high flow bypass or overflow must be included in underground detention designs to safely pass the extreme flood flow.
- **Primary Spillway (dry ponds).** The primary spillway shall be designed with acceptable anti-flotation, anti-vortex, and trash rack devices. The spillway must generally be accessible from dry land. When reinforced concrete pipe is used for the principal spillway to increase its longevity, “O”-ring gaskets (ASTM C361) must be used to create watertight joints, and they should be inspected during installation.
- **Avoid Outlet Clogging (dry ponds).** The risk of clogging in outlet pipes with small orifices can be reduced by the following:
  - ◆ Providing a micropool at the outlet structure. For more information on micropool extended detention ponds see Section 3.10 Ponds.
  - ◆ Installing a trash rack to screen the low-flow orifice.
  - ◆ Using a perforated pipe under a gravel blanket with an orifice control at the end in the riser structure.
- **Emergency Spillway (dry ponds).** Dry ponds must be constructed with overflow capacity to safely pass the 100-year design storm event through either the primary spillway or a vegetated or armored emergency spillway unless waived by DOEE.
- **Inlet Protection (dry ponds).** Inflow points into dry pond systems must be stabilized to ensure that non-erosive conditions exist during storm events up to the overbank flood event (i.e., the 15-year storm event).

### 3.12.3 Storage Pretreatment Criteria

**Dry Pond Pretreatment Forebay.** A forebay must be located at each major inlet to a dry pond to trap sediment and preserve the capacity of the main treatment cell. The following criteria apply to dry pond forebay design:

- A major inlet is defined as an individual storm drain inlet pipe or open channel serving at least 10% of the storage practice’s CDA.
- The forebay consists of a separate cell, formed by an acceptable barrier (e.g., an earthen berm, concrete weir, gabion baskets, etc.).



- The forebay shall be sized to contain 0.1 inch per impervious acre of contributing drainage. The relative size of individual forebays should be proportional to the percentage of the total inflow to the dry pond.
- The forebay should be designed in such a manner that it acts as a level spreader to distribute runoff evenly across the entire bottom surface area of the main storage cell.
- Exit velocities from the forebay shall be non-erosive or an armored overflow shall be provided. Non-erosive velocities are 4 feet per second for the 2-year event and 6 feet per second for the 15-year event.
- The bottom of the forebay may be hardened (e.g., concrete, asphalt, or grouted riprap) in order to make sediment removal easier.
- Direct maintenance access for appropriate equipment shall be provided to the each forebay.

**Underground Detention Pretreatment.** A pretreatment structure to capture sediment, coarse trash, and debris must be placed upstream of any inflow points to underground detention. A separate sediment sump or vault chamber sized to capture 0.1 inch per impervious acre of contributing drainage, or a proprietary structure with demonstrated capability of removing sediment and trash, should be provided at the inlet for underground detention systems that are in a treatment train with off-line water quality treatment structural controls. Refer to Section 3.13 Proprietary Practices for information on approved proprietary practices.

#### 3.12.4 Storage Design Criteria

**Dry Pond Internal Design Features.** The following apply to dry pond design:

- **No Pilot Channels.** Dry ponds shall not have a low-flow pilot channel, but instead must be constructed in a manner whereby flows are evenly distributed across the pond bottom, to avoid scour, promote attenuation and, where possible, infiltration.
- **Internal Slope.** The maximum longitudinal slope through the pond should be approximately 0.5%–1%.
- **Side Slopes.** Side slopes within the dry pond should generally have a gradient of 3H:1V to 4H:1V. The mild slopes promote better establishment and growth of vegetation and provide for easier maintenance and a more natural appearance. Ponds with side slopes steeper than 5H:1V must be fenced and include a lockable gate.
- **Long Flow Path.** Dry pond designs should have an irregular shape and a long flow path distance from inlet to outlet to increase water residence time, treatment pathways, pond performance, and to eliminate short-cutting. In terms of flow path geometry, there are two design considerations: (1) the overall flow path through the pond, and (2) the length of the shortest flow path (Hirschman et al., 2009):
  - ◆ The overall flow path can be represented as the length-to-width ratio OR the flow path ratio. These ratios must be at least 2L:1W (3L:1W preferred). Internal berms, baffles, or topography can be used to extend flow paths and/or create multiple pond cells.
  - ◆ The shortest flow path represents the distance from the closest inlet to the outlet. The ratio of the shortest flow to the overall length must be at least 0.4. In some cases—due to

site geometry, storm sewer infrastructure, or other factors—some inlets may not be able to meet these ratios. However, the CDA served by these “closer” inlets must constitute no more than 20% of the total CDA.

**Safety Features.** The following safety features must be considered for storage practices:

- The principal spillway opening must be designed and constructed to prevent access by small children.
- End walls above pipe outfalls greater than 48 inches in diameter must be fenced at the top of the wall to prevent a falling hazard.
- Storage practices must incorporate an additional 1 foot of freeboard above the emergency spillway, or 2 feet of freeboard if design has no emergency spillway, for the maximum  $Q_f$  design storm unless more stringent Dam Safety requirements apply.
- The emergency spillway must be located so that downstream structures will not be impacted by spillway discharges
- Underground maintenance access should be locked at all times.

**Maintenance Access.** All storage practices shall be designed so as to be accessible to annual maintenance. Unless waived by the DOEE, a 5H:1V slope and 15-foot-wide entrance ramp is required for maintenance access to dry ponds. Adequate maintenance access must also be provided for all underground detention systems. Access must be provided over the inlet pipe and outflow structure with access steps. Access openings can consist of a standard 30-inch diameter frame, grate and solid cover, a hinged door, or removable panel. Removable panels must be designed with sufficient support so they cannot fall through the opening into the vault when removed.

**Outlets.** Trash racks shall be provided for low-flow pipes and for risers not having anti-vortex devices.

In order to reduce maintenance problems for small orifices, a standpipe design can be used that includes a smaller inner standpipe with the required orifice size, surrounded by a larger standpipe with multiple openings, and a gravel jacket surrounding the larger standpipe. This design will reduce the likelihood of the orifice being clogged by sediment.

**Detention Vault and Tank Materials.** Underground stormwater detention structures shall be composed of materials as approved by DOEE. All construction joints and pipe joints shall be water tight. Cast-in-place wall sections must be designed as retaining walls. The maximum depth from finished grade to the vault invert is 20 feet. The minimum pipe diameter for underground detention tanks is 24 inches unless otherwise approved by DOEE. Manufacturer’s specifications should be consulted for underground detention structures.

**Anti-floatation Analysis for Underground Detention.** Anti-floatation analysis is required to check for buoyancy problems in high water table areas. Anchors shall be designed to counter the pipe and structure buoyancy by at least a 1.2 factor of safety.

**Storage Practice Sizing.** Storage facilities should be sized to control peak flow rates from the 2-year and 15-year frequency storm event or other design storm. Design calculations must ensure that the post-development peak discharge does not exceed the predevelopment peak discharge. See Section 2.10 Hydrology Methods for a summary of acceptable hydrologic methodologies and models.

For treatment train designs where upland practices are utilized for treatment of the SWRV, designers can use a site-adjusted Rv or NRCS CN that reflects the volume reduction of upland practices to compute the Qp<sub>2</sub> and Qp<sub>15</sub> that must be treated by the storage practice.

### 3.12.5 Storage Landscaping Criteria

No landscaping criteria apply to underground storage practices.

For dry ponds, a landscaping plan must be provided that indicates the methods used to establish and maintain vegetative coverage within the dry pond. Minimum elements of a plan include the following:

- Delineation of pondscaping zones within the pond.
- Selection of corresponding plant species.
- The planting plan.
- The sequence for preparing the wetland bed, if one is incorporated with the dry pond (including soil amendments, if needed).
- Sources of native plant material.
- The planting plan should allow the pond to mature into a native forest in the right places, but yet keep mowable turf along the embankment and all access areas. The wooded wetland concept proposed by Cappiella et al. (2005) may be a good option for many dry ponds.
- Woody vegetation may not be planted or allowed to grow within 15 feet of the toe of the embankment nor within 25 feet from the principal spillway structure.

### 3.12.6 Storage Construction Sequence

Construction of underground storage systems must be in accordance with manufacturer's specifications. All runoff into the system should be blocked until the site is stabilized. The system must be inspected and cleaned of sediment after the site is stabilized.

The following is a typical construction sequence to properly install a dry pond. The steps may be modified to reflect different dry pond designs, site conditions, and the size, complexity, and configuration of the proposed facility.

**Step 1: Use of Dry Pond for Soil Erosion and Sediment Control.** A dry pond may serve as a sediment basin during project construction. Installation of the permanent riser should be initiated during the construction phase, and design elevations should be set with final cleanout of the sediment basin and conversion to the post-construction dry pond in mind. The bottom elevation of the dry pond should be lower than the bottom elevation of the temporary sediment

basin. Appropriate procedures must be implemented to prevent discharge of turbid waters when the basin is being converted into a dry pond.

**Step 2: Stabilize the Contributing Drainage Area.** Dry ponds should only be constructed after the CDA to the pond is completely stabilized. If the proposed dry pond site will be used as a sediment trap or basin during the construction phase, the construction notes must clearly indicate that the facility will be dewatered, dredged, and regraded to design dimensions after the original site construction is complete.

**Step 3: Assemble Construction Materials On Site.** Inspect construction materials to ensure they conform to design specifications and prepare any staging areas.

**Step 4: Clear and Grade.** Bring the project area to the desired subgrade.

**Step 5: Soil Erosion and Sediment Controls.** Install soil erosion and sediment control measures prior to construction, including temporary stormwater diversion practices. All areas surrounding the pond that are graded or denuded during construction must be planted with turf grass, native plantings, or other approved methods of soil stabilization.

**Step 6: Install the Spillway Pipe.** Ensure the top invert of the spillway pipe is set to design elevation.

**Step 7: Install the Riser or Outflow Structure.** Once riser and outflow structures are installed, ensure the top invert of the overflow weir is constructed level and at the design elevation.

**Step 8: Construct the Embankment and any Internal Berms.** Construct the embankment and berms in 8- to 12-inch lifts and compact the lifts with appropriate equipment.

**Step 9: Excavate and Grade.** Survey to achieve the appropriate elevation and designed contours for the bottom and side slopes of the dry pond.

**Step 10: Construct the Emergency Spillway.** The emergency spillway must be constructed in cut or structurally stabilized soils.

**Step 11: Install Outlet Pipes.** The installation of outlet pipes must include a downstream riprap protection apron.

**Step 12: Stabilize Exposed Soils.** All areas above the normal pool elevation should be permanently stabilized by hydroseeding or seeding over straw.

**Dry Pond Construction Supervision.** Ongoing construction supervision is recommended to ensure that stormwater ponds are properly constructed. Supervision/inspection is recommended during the following stages of construction:

- Preconstruction meeting
- Initial site preparation including the installation of soil erosion and sediment control measures
- Excavation/grading (interim and final elevations)
- Installation of the embankment, the riser/primary spillway, and the outlet structure
- Implementation of the pondscaping plan and vegetative stabilization

- Final inspection (develop a punch list for facility acceptance)

DOEE's construction phase inspection checklist for storage practices and the Stormwater Facility Management Standard Testing Record form can be found in Appendix L - Construction Inspection Checklists

If the dry pond has a permanent pool, then to facilitate maintenance the contractor should measure the actual constructed dry pond depth at three areas within the permanent pool (forebay, mid-pond, and at the riser), and they should mark and geo-reference them on an as-built drawing. This simple data set will enable maintenance inspectors to determine pond sediment deposition rates in order to schedule sediment cleanouts.

### 3.12.7 Storage Maintenance Criteria

Typical maintenance activities for storage practices are outlined in Table 3-47. Maintenance requirements for underground storage facilities will generally require quarterly visual inspections from the manhole access points by a qualified professional to verify that there is no standing water or excessive sediment buildup. Entry into the system for a full inspection of the system components (pipe or vault joints, general structural soundness, etc.) should be conducted annually. Confined space entry credentials are typically required for this inspection.

**Table 3-47 Typical Maintenance Activities for Storage Practices**

Schedule	Maintenance Activity
As needed	<ul style="list-style-type: none"> <li>▪ Water dry pond side slopes to promote vegetation growth and survival.</li> </ul>
Quarterly	<ul style="list-style-type: none"> <li>▪ Remove sediment and oil/grease from inlets, pretreatment devices, flow diversion structures, storage practices, and overflow structures.</li> <li>▪ Ensure that the CDA, inlets, and facility surface are clear of debris.</li> <li>▪ Ensure that the CDA is stabilized. Perform spot-reseeding where needed.</li> <li>▪ Repair undercut and eroded areas at inflow and outflow structures.</li> </ul>
Annual inspection	<ul style="list-style-type: none"> <li>▪ Measure sediment accumulation levels in forebay. Remove sediment when 50% of the forebay capacity has been lost.</li> <li>▪ Inspect the condition of stormwater inlets for material damage, erosion, or undercutting. Repair as necessary.</li> <li>▪ Inspect the banks of upstream and downstream channels for evidence of sloughing, animal burrows, boggy areas, woody growth, or gully erosion that may undermine pond embankment integrity.</li> <li>▪ Inspect outfall channels for erosion, undercutting, riprap displacement, woody growth, etc.</li> <li>▪ Inspect condition of principal spillway and riser for evidence of spalling, joint failure, leakage, corrosion, etc.</li> <li>▪ Inspect condition of all trash racks, reverse sloped pipes, or flashboard risers for evidence of clogging, leakage, debris accumulation, etc.</li> <li>▪ Inspect maintenance access to ensure it is free of debris or woody vegetation and check to see whether valves, manholes, and locks can be opened and operated.</li> <li>▪ Inspect internal and external side slopes of dry ponds for evidence of sparse vegetative cover, erosion, or slumping, and make needed repairs immediately.</li> <li>▪ Monitor the growth of wetlands, trees, and shrubs planted in dry ponds. Remove invasive species and replant vegetation where necessary to ensure dense coverage.</li> </ul>

Maintenance of storage practices is driven by annual inspections that evaluate the condition and performance of the storage practice. Based on inspection results, specific maintenance tasks will be triggered.

DOEE’s maintenance inspection checklists for extended detention ponds and the Maintenance Service Completion Inspection form can be found in Appendix M - Maintenance Inspection Checklists.

**Declaration of Covenants.** A declaration of covenants that includes all maintenance responsibilities to ensure the continued stormwater performance for the BMP is required. The declaration of covenants specifies the property owner’s primary maintenance responsibilities, and authorizes DOEE staff to access the property for inspection or corrective action in the event the proper maintenance is not performed. The declaration of covenants is recorded in the District of Columbia land records. A template form is provided at the end of Chapter 5 Administration of Stormwater Management Rules (see Figure 5.11), although variations will exist for scenarios where stormwater crosses property lines. The covenant is between the property and the Government of the District of Columbia. It is submitted through the Office of the Attorney General. All SWMPs have a maintenance agreement stamp that must be signed for a building permit to proceed. A maintenance schedule must appear on the SWMP. Additionally, a maintenance schedule is required in Exhibit C of the declaration of covenants.

Covenants are not required on government properties, but maintenance responsibilities must be defined through a partnership agreement or a memorandum of understanding.

**Waste Material.** Waste material from the repair, maintenance, or removal of a BMP or land cover shall be removed and disposed of in compliance with applicable federal and District law.

### 3.12.8 Storage Volume Compliance Calculations

Storage practices receive no retention value and are not an accepted total suspended solids (TSS) treatment practice (Table 3-48). These practices should be used only for control of larger storm events.

**Table 3-48 Storage Retention Value and Pollutant Removal**

Retention Value	= 0
Accepted TSS Treatment Practice	No

### 3.12.9 References

ASTM C361-16, Standard Specification for Reinforced Concrete Low-Head Pressure Pipe, ASTM International, West Conshohocken, PA, 2016, [www.astm.org](http://www.astm.org)

Cappiella, K., Schueler, T., and T. Wright. 2005. Urban Watershed Forestry Manual. Part 1: Methods for Increasing Forest Cover in a Watershed. NA-TP-04-05. USDA Forest Service, Northeastern Area State and Private Forestry. Newtown Square, PA.

City of Austin. 1988. Design Guidelines for Water Quality Control Basins. City of Austin Environmental and Conservation Services Department, Environmental Resources Management Division. Austin, TX.

Hirschman, D., L. Woodworth and S. Drescher. 2009. Technical Report: Stormwater BMPs in Virginia's James River Basin: An Assessment of Field Conditions & Programs. Center for Watershed Protection. Ellicott City, MD.

Virginia DCR Stormwater Design Specification No. 15: Extended Detention (ED) Pond Version 1.8. 2010.





### 3.13 Proprietary Practices

**Definition.** Proprietary practices are manufactured stormwater treatment practices that utilize settling, filtration, absorptive/adsorptive materials, vortex separation, vegetative components, and/or other appropriate technology to manage the impacts stormwater runoff. The design includes the following:

#### M-1 Proprietary practices

Proprietary practices may be used to achieve treatment compliance, provided they have been approved by the District and meet the performance criteria outlined in this specification. Historically, proprietary practices do not provide retention volume. A proprietary practice will not be valued for retention volume unless the practice can demonstrate the occurrence of retention processes.

#### 3.13.1 Proprietary Practice Feasibility Criteria

Individual proprietary practices will have different site constraints and limitations. Manufacturer's specifications should be consulted to ensure that proprietary practices are feasible for application on a site-by-site basis.

#### 3.13.2 Proprietary Practice Conveyance Criteria

All proprietary practices must be designed to safely overflow or bypass flows from larger storm events to downstream drainage systems. The overflow associated with the 2-year and 15-year design storms must be controlled so that velocities are non-erosive at the outlet point (i.e., to prevent downstream erosion).

Manufactured treatment devices may be constructed on-line or off-line. On-line systems receive upstream runoff from all storms, providing runoff treatment for the stormwater quality design storm and conveying the runoff from larger storms through an overflow. In off-line devices, most or all of the runoff from storms larger than the stormwater quality design storm bypass the device through an upstream diversion or other mechanism.

#### 3.13.3 Proprietary Practice Pretreatment Criteria

Individual proprietary practices may require pretreatment, or may be appropriate for use as pretreatment devices. Manufacturer's specifications should be consulted to determine the device-specific pretreatment requirements.

#### 3.13.4 Proprietary Practice Design Criteria

The basic design parameters for a proprietary practice will depend on the techniques it employs to control stormwater runoff and remove particulate and dissolved pollutants from runoff. In general, the design of devices that treat runoff with no significant storage and flow rate attenuation must be based upon the peak design flow rate. However, devices that do provide storage and flow rate attenuation must be based, at a minimum, on the design storm runoff

volume and, in some instances, on a routing of the design runoff hydrograph. Hydrologic design is discussed further in Appendix I - - Acceptable Hydrologic Methods and Models.

Appendix T - Proprietary Practices Approval Process includes details of the verification process and the required data submittals for determination of proprietary practice performance.

Adequate maintenance access must be provided for all proprietary practice systems. Access, with access steps, as applicable, must be provided for the inlet pipe, outflow structure, and over any other functional components.

### **3.13.5 Proprietary Practice Landscaping Criteria**

Proprietary devices may or may not require landscaping considerations. Manufacturer's specifications should be consulted to determine any landscaping requirements for the device.

### **3.13.6 Proprietary Practice Construction Sequence**

The construction and installation of individual proprietary practices will vary based on the specific proprietary practice. Manufacturer's specifications should be consulted to determine the device specific construction sequencing requirements. DOEE's construction inspection checklist for generic structural BMPs can be found in Appendix L - Construction Inspection Checklists.

### **3.13.7 Proprietary Practice Maintenance Criteria**

In order to ensure effective and long-term performance of a proprietary practice, regular maintenance tasks and inspections are required.

All proprietary practices should be inspected by a qualified professional and maintained in accordance with the manufacturer's instructions and/or recommendations and any maintenance requirements associated with the device's verification by DOEE.

DOEE's maintenance inspection checklist for generic structural BMPs and the Maintenance Service Completion Inspection form can be found in Appendix M - Maintenance Inspection Checklists.

**Declaration of Covenants.** A declaration of covenants that includes all maintenance responsibilities to ensure the continued stormwater performance for the BMP is required. The declaration of covenants specifies the property owner's primary maintenance responsibilities, and authorizes DOEE staff to access the property for inspection or corrective action in the event the proper maintenance is not performed. The declaration of covenants is recorded in the District of Columbia land records. A template form is provided at the end of Chapter 5 Administration of Stormwater Management Rules (see Figure 5.11), although variations will exist for scenarios where stormwater crosses property lines. The covenant is between the property and the Government of the District of Columbia. It is submitted through the Office of the Attorney General. All SWMPs have a maintenance agreement stamp that must be signed for a building permit to proceed. A maintenance schedule must appear on the SWMP. Additionally, a maintenance schedule is required in Exhibit C of the declaration of covenants.

Covenants are not required on government properties, but maintenance responsibilities must be defined through a partnership agreement or a memorandum of understanding.

**Waste Material.** Waste material from the repair, maintenance, or removal of a BMP or land cover shall be removed and disposed of in compliance with applicable federal and District law.

### **3.13.8 Proprietary Practice Stormwater Compliance Calculations**

Proprietary practices receive retention value when explicitly approved by the District. Pollutant removal (TSS EMC reduction) may be awarded for specific practices provided that they meet the performance criteria outlined in Section 3.13.4, “Proprietary Practice Design Criteria.”



## 3.14 Tree Planting and Preservation

**Definition.** Existing trees can be preserved or new trees can be planted to reduce stormwater runoff. The design includes the following:

T-1 Tree planting

T-2 Tree preservation

Tree canopy can intercept a significant amount of rainfall before it becomes runoff, particularly if the tree canopy covers impervious surfaces, as in the case of street trees. Through the processes of evapotranspiration and nutrient uptake, trees—even when located on a development site—have the capacity to reduce stormwater runoff volumes and improve water quality. Further, through root growth, trees can improve the infiltration capacity of the soils in which they grow.

Both tree planting and tree preservation can contribute to stormwater management on a site. Note that retention value is available for preserved trees only when they are within the limits of disturbance of a project. Preserved trees outside of the limits of disturbance may offer an opportunity for additional retention when they constitute an area of natural cover and stormwater is conveyed to that area.

### 3.14.1 Preserving Existing Trees During Construction

The preferred method for increasing tree cover at a development site is to preserve existing trees during construction, particularly where mature trees are present. Existing trees are preserved during construction through a four-step process:

- Step 1:** Inventory existing trees.
- Step 2:** Identify trees to preserve.
- Step 3:** Protect trees and soil during construction.
- Step 4:** Protect trees after construction.

**Inventory Existing Trees.** An inventory of existing trees and forested areas at the development site must be conducted before any site design, clearing, or construction takes place, as specified by the DDOT UFD. The inventory must be conducted by one of the following landscape professionals:

- Maryland Licensed Forester
- Maryland Licensed Tree Expert
- Virginia Experienced Forester
- Maryland or Virginia Licensed Landscape Architect
- International Society of Arboriculture (ISA) Certified Arborist

The inventory must include a survey of existing trees and determine their size, species, condition, and ecological value. Locations of trees and forest stands must be recorded. Special

Trees and Heritage Trees, defined by Tree Canopy Protection Amendment Act of 2016 as having a minimum circumference of 44 or 100 inches, respectively, will require special permitting and qualify for a higher retention credit.

**Identify Trees to Preserve.** From the tree inventory, individual trees can be identified for preservation and protection during site development. Preserved trees fall into four categories of retention value: tree species with a mature canopy spread of 40 feet or less (“small” trees) receive 10 cubic feet of retention value; trees species with a mature canopy spread greater than 40 feet (“large” trees) receive 20 cubic feet of retention value; Special Trees receive 30 cubic feet of retention value, regardless of mature canopy spread size; and Heritage Trees receive 40 cubic feet of retention value, regardless of mature spread size. Additional selection criteria may include tree species, size, condition, and location (see Table 3-49).

**Refer to the planting guides provided by DOEE’s Green Area Ratio Guidebook to determine plant species’ average mature canopy spread. Table 3-49 Selecting Priority Trees and Forests for Preservation**

Selection Criteria for Tree Preservation	Examples of Priority Tree and Forests to Conserve
Species	<ul style="list-style-type: none"> <li>▪ Rare, threatened, or endangered species</li> <li>▪ Specimen trees</li> <li>▪ High quality tree species (e.g., white oaks and sycamores because they are structurally strong and live longer than trees such as silver maple and cottonwood)</li> <li>▪ Species that are tolerant of specific site conditions and soils</li> </ul>
Size	<ul style="list-style-type: none"> <li>▪ Trees over a specified diameter at breast height (DBH) or other size measurement</li> <li>▪ Trees designated as national, state, or local champions</li> <li>▪ Contiguous forest stands</li> </ul>
Condition	<ul style="list-style-type: none"> <li>▪ Healthy trees that are structurally sound in “fair” or better condition</li> <li>▪ High quality forest stands with high forest structural diversity</li> </ul>
Location	<ul style="list-style-type: none"> <li>▪ Trees located where they will provide direct benefits at the site (e.g., shading, privacy, windbreak, buffer from adjacent land use)</li> <li>▪ Forest stands that are connected to off-site forests that create wildlife habitat and corridors</li> <li>▪ Trees located in protected natural areas such as floodplains, stream buffers, wetlands, erodible soils, critical habitat areas, and steep slopes.</li> <li>▪ Forest stands that are connected to off-site non-forested natural areas or protected land (e.g., has potential to provide wildlife habitat)</li> </ul>

Trees selected for preservation and protection must be clearly marked both on construction drawings and at the actual site. Flagging or fencing is typically used to protect trees at the construction site. Areas of trees to preserve should be marked on the site map and walked during preconstruction meetings.

**Protect Trees and Soil During Construction.** Physical barriers should be properly installed around the Critical Root Zone (CRZ) of trees to be preserved. The CRZ shall be determined by a landscape professional from the above list, and in general is equal to 1.5 feet of tree protection (radius of circle) for every 1 inch in tree diameter. For example, a 10-inch diameter tree would

have a CRZ radius extending 15 feet from the tree. The barriers must be maintained and enforced throughout the construction process. Tree protection barriers include highly visible, well-anchored temporary protection devices, such as 6-foot-tall chain link or 4-foot wooden snow fencing. All protection devices must remain in place throughout construction.

If land disturbance is proposed within the CRZ, the tree may be counted for preservation only if a tree preservation plan is prepared and certified by one of the landscape professionals in the list above (see “Inventory Existing Trees” section). Refer to DOEE’s Erosion and Sediment Control Manual regarding tree protection measures that can be taken during construction.

Preserved tree BMPs must be included within the limit of disturbance (LOD) delineated on the plans to be counted toward meeting stormwater management requirements, even if no disturbance takes place within the protected zone.

**Protect Trees After Construction.** Maintenance covenants, as described below, are required to ensure that preserved trees are protected.

### 3.14.2 Planting Trees

**Considerations at Development Sites.** New development sites provide many opportunities to plant new trees. Planting trees at development sites is done in three steps:

**Step 1:** Select tree species.

**Step 2:** Evaluate and improve planting sites.

**Step 3:** Plant and maintain trees.

**Tree Species.** Planted trees fall into two categories of retention value: tree species with a mature canopy spread 40 feet or less (“small” trees) receive 5 cubic feet of retention value and trees species with a mature canopy spread greater than 40 feet (“large” trees) receive 10 cubic feet of retention value. Trees to be planted must have a minimum caliper size of 1.5 inches.

Refer to the planting guides provided by DOEE’s Green Area Ratio Guidebook to determine plant species’ average mature spread. **Planting Sites.** Ideal planting sites within a development are those that create interception opportunities around impervious surfaces. These include areas along pathways, roads, islands and median strips, and parking lot interiors and perimeters. Other areas of a development site may benefit from planting trees (including stream valleys and floodplains, areas adjacent to existing forest, steep slopes, and portions of the site where trees would provide buffers, screening, noise reduction, or shading).

It is important to evaluate and record the conditions, such as soil type, soil pH, soil compaction, and the hydrology of proposed planting sites to ensure they are suitable for planting. These evaluations provide a basis for species selection and determination of the need for any special site preparation techniques.

A minimum of 1,500 cubic feet of rootable soil volume must be provided per large tree. In planting arrangements that allow for shared rooting space amongst multiple trees, a minimum of 1,000 cubic feet of rootable soil volume must be provided for each large tree. Rootable soil

volume must be within 3 feet of the surface and must be available within the project property boundaries.

Smaller trees with a mature canopy spread of 40 feet or less must have a minimum of 600 cubic feet of rootable soil volume. In planting arrangements that permit shared rooting space amongst multiple trees, a minimum of 400 cubic feet of rootable soil volume must be provided for each tree. Rootable soil volume must be within 3 feet of the surface.

Site characteristics determine what tree species will flourish there and whether any of the conditions, such as soils, can be improved through the addition of compost or other amendments. Table 3-50 presents methods for addressing common constraints to urban tree planting.

**Table 3-50 Methods for Addressing Urban Planting Constraints**

Potential Impact	Potential Resolution
Limited Soil Volume	<ul style="list-style-type: none"> <li>▪ Provide 1,500 cubic feet of rootable soil volume per large tree (mature canopy spread greater than 40 feet) and 600 cubic feet of rootable soil volume per small tree (mature canopy spread of 40 feet or less). This soil must be within 3 feet of the surface.</li> <li>▪ Use planting arrangements that allow shared rooting space. A minimum of 1,000 cubic feet of rootable soil volume must be provided for each large tree in shared rooting space arrangements.</li> <li>▪ A minimum of 400 cubic feet of rootable soil volume must be provided for each small tree in shared rooting arrangements.</li> </ul>
Poor Soil Quality	<ul style="list-style-type: none"> <li>▪ Test soil and perform appropriate restoration.</li> <li>▪ Select species tolerant of soil pH, compaction, drainage, etc.</li> <li>▪ Replace very poor soils if necessary.</li> </ul>
Air Pollution	<ul style="list-style-type: none"> <li>▪ Select species tolerant of air pollutants.</li> </ul>
Damage from Lawnmowers	<ul style="list-style-type: none"> <li>▪ Use mulch to protect trees.</li> </ul>
Damage from Vandalism	<ul style="list-style-type: none"> <li>▪ Use tree cages or benches to protect trees.</li> <li>▪ Select species with inconspicuous bark or thorns.</li> <li>▪ Install lighting nearby to discourage vandalism.</li> </ul>
Damage from Vehicles	<ul style="list-style-type: none"> <li>▪ Provide adequate setbacks between vehicle parking stalls and trees.</li> </ul>
Damage from animals such as deer, rodents, rabbits, and other herbivores	<ul style="list-style-type: none"> <li>▪ Use protective fencing or chemical retardants.</li> </ul>
Exposure to pollutants in stormwater and snowmelt runoff	<ul style="list-style-type: none"> <li>▪ Select species that are tolerant of specific pollutants, such as salt and metals.</li> </ul>
Soil moisture extremes	<ul style="list-style-type: none"> <li>▪ Select species that are tolerant of inundation or drought.</li> <li>▪ Install underdrains if necessary.</li> <li>▪ Select appropriate backfill soil and mix thoroughly with site soil.</li> <li>▪ Improve soil drainage with amendments and tillage if needed.</li> </ul>
Increased temperature	<ul style="list-style-type: none"> <li>▪ Select drought tolerant species.</li> </ul>
Increased wind	<ul style="list-style-type: none"> <li>▪ Select drought tolerant species.</li> </ul>
Abundant populations of invasive species	<ul style="list-style-type: none"> <li>▪ Control invasive species prior to planting.</li> <li>▪ Continually monitor for and remove invasive species.</li> </ul>



Potential Impact	Potential Resolution
Conflict with infrastructure	<ul style="list-style-type: none"> <li>▪ Design the site to keep trees and infrastructure separate.</li> <li>▪ Provide appropriate setbacks from infrastructure.</li> <li>▪ Select appropriate species for planting near infrastructure.</li> <li>▪ Use alternative materials to reduce conflict.</li> </ul>
Disease or insect infestation	<ul style="list-style-type: none"> <li>▪ Select resistant species</li> </ul>

Planting trees at development sites requires prudent species selection, a maintenance plan, and careful planning to avoid impacts from nearby infrastructure, runoff, vehicles or other urban elements.

**Trees Along Streets and in Parking Lots.** When considering a location for planting, clear lines of sight must be provided, as well as safe travel surfaces, and overhead clearance for pedestrians and vehicles. Also, ensure enough soil volume for healthy tree growth. Usable soil must be uncompacted and may not be covered by impervious material, unless structural soils or other tree soil systems are utilized. Having at least a 6-foot-wide planting strip or locating sidewalks between the trees and street allows more rooting space for trees in adjacent property.

Select tree species that are drought tolerant, can grow in poor or compacted soils, and are tolerant to typical urban pollutants (oil and grease, metals, and chlorides). Additionally, select species that do not produce excessive fruits, nuts, or leaf litter, that have fall color, spring flowers or some other aesthetic benefit, and can be limbed up to 6 feet to provide pedestrian and vehicle traffic underneath. The DDOT UFD provides guidance on preferred street tree species based on neighborhoods.

**Planting Techniques.** Prepare a hole no deeper than the root ball or mass but two to three times wider than the spread of the root ball or mass. The majority of the roots on a newly planted tree will develop in the top 12 inches of soil and spread out laterally. There are some additional considerations depending on the type of plant material being used (Table 3-51).

**Table 3-51 Tree Planting Techniques**

Plant Material	Planting Technique	Planting Season
Bare root	Hand plant	Spring or fall when tree is dormant
Container grown	Hand plant or use mechanical planting tools (e.g., auger)	Spring or fall, summer if irrigated
Balled and burlapped	Use backhoe (or other specialized equipment) or hand plant	Spring or fall

Sources: Palone and Todd (1998), WSAHGP (2002)

One of the most important planting guidelines is to make sure the tree is not planted too deeply. The root collar, the lowest few inches of trunk just above its junction with the roots (often indicated by a flare), should be exposed. Trees planted too deeply have buried root collars, and are weakened, stressed, and predisposed to pests and disease. Trees planted too deeply can also form adventitious roots near the soil surface in an attempt to compensate for the lack of oxygen available to buried roots. Adventitious roots are not usually large enough to provide support for a

large tree and may eventually lead to collapse. ISA (2005) provides additional guidance on how to avoid planting too deeply. It is generally better to plant the tree a little high, that is, with the base of the trunk flare 2 to 3 inches above the soil, rather than at or below the original growing level.

Proper handling during planting is essential to avoid prolonged transplant shock and ensure a healthy future for new trees and shrubs. Trees should always be handled by the root ball or container, never by the trunk. Specifications for planting a tree are illustrated in Figure 3.46. Trees must be watered well after planting.

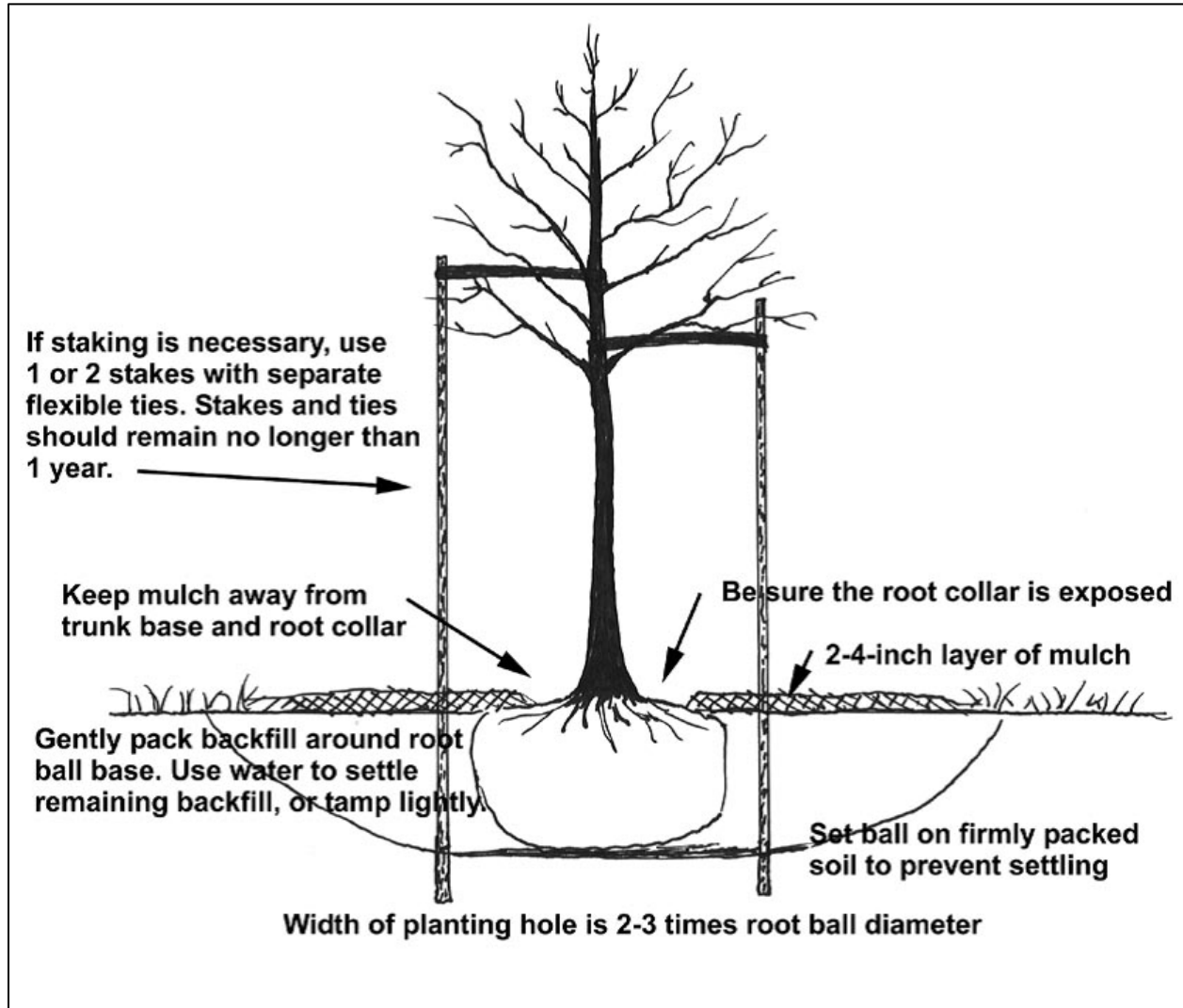


Figure 3.46 Tree planting guidelines. (Adapted from Flott, 2004 and ISA, 2003b).

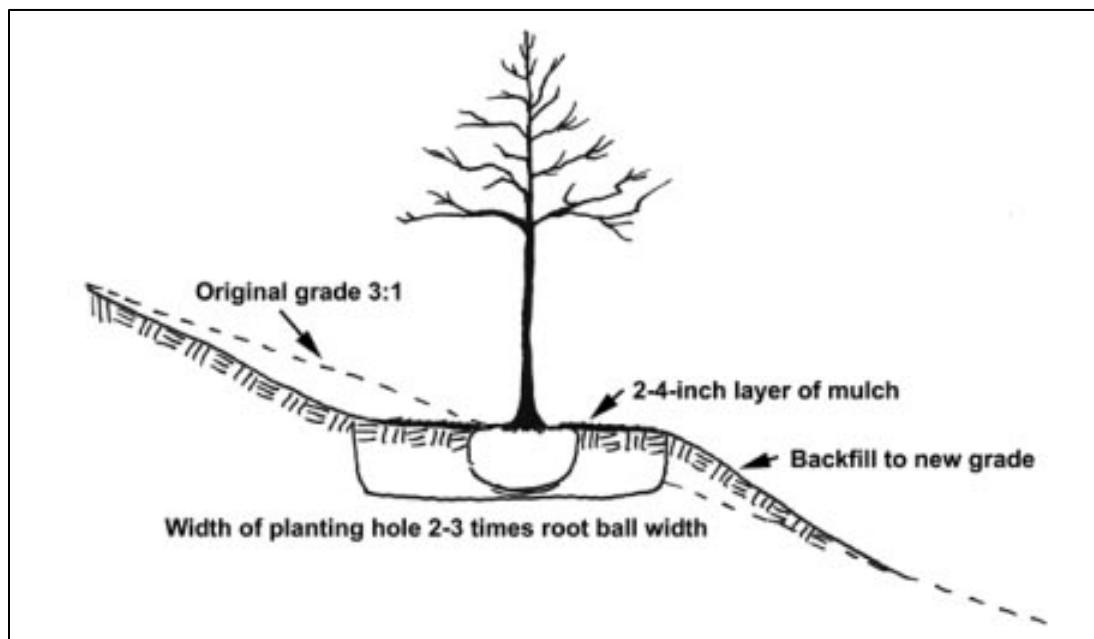
Steep slopes require additional measures to ensure planting success and reduce erosion, especially if the slope receives stormwater runoff from upland land uses. Depending on the

steepness of the slope and the runoff volume, rill or gully erosion may occur on these slopes, requiring a twofold approach: controlling the stormwater and stabilizing the slope.

Erosion control blankets are recommended to temporarily stabilize soil on slopes until vegetation is established. Erosion control fabrics come in a variety of weights and types, and should be combined with vegetation establishment such as seeding. Other options for stabilizing slopes include applying compost or bark mulch, plastic sheeting, or sodding.

Trees will add stability to slopes because of their deep roots, provided they are not planted by digging rows of pits across a slope. Required maintenance will include mowing (if slopes are not too steep), and establishing cover on bare or eroded areas.

Planting methods for slopes steeper than 3H:1V involve creating a level planting space on the slope (see Figure 3.47). A terrace can be dug into the slope in the shape of a step. The existing slope can be cut and the excavated soil can be used as fill. A low soil berm (or rock berm) can be formed at the front edge of each step or terrace to slow the flow of water. Trees can also be planted in clusters on slopes (using the above method) to limit potential for desiccation. Staggering tree placement and mulching will prevent water from running straight downhill.



**Figure 3.47** The specifications for planting on a steep slope, require creating a level planting surface.

**Post-Planting Tree Protection.** Once the tree has been properly planted, 2 to 4 inches of organic mulch must be spread over the soil surface out to the drip line (the outermost circumference of the tree canopy) of the tree. If planting a cluster of trees, mulch the entire planting area. Slow-decomposing organic mulches, such as shredded bark, compost, leaf mulch, or wood chips provide many added benefits for trees. Mulch that contains a combination of

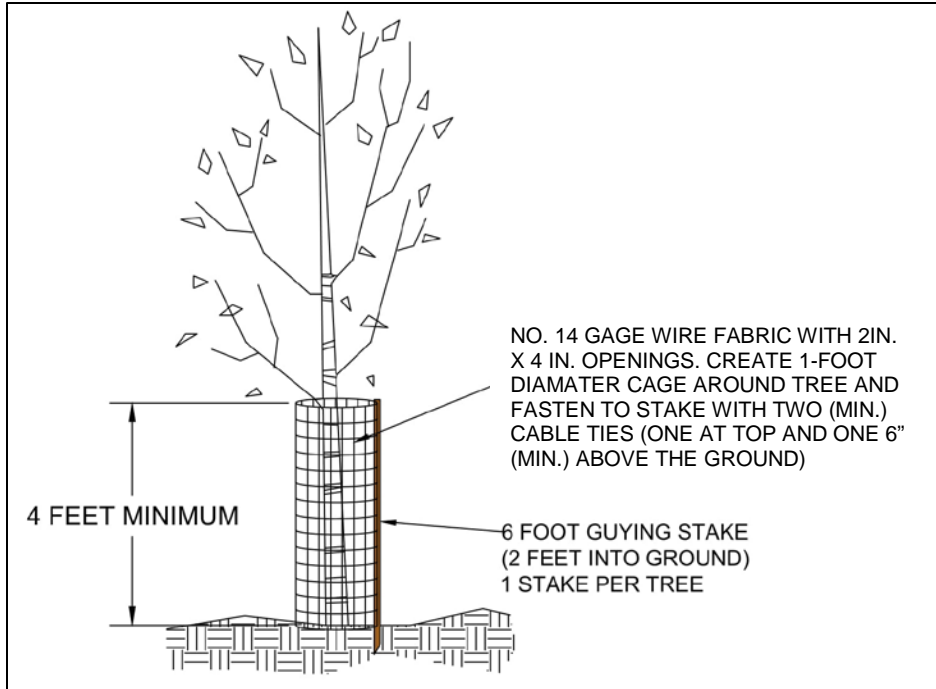
chips, leaves, bark, and twigs is ideal for reforestation sites. Grass clippings and sawdust are not recommended as mulches because they decompose rapidly and require frequent application, resulting in reduced benefits.

For well-drained sites, up to 4 inches of mulch may be applied. For poorly drained sites, a thinner layer of mulch should be applied. Mulch should never be more than 4 inches deep or applied right next to the tree trunk; however, a common sight in many landscaped areas is the “mulch volcano.” This over-mulching technique can cause oxygen and moisture-level problems, and decay of the living bark at the base of the tree. A mulch-free area, 2 to 3 inches wide at the base of the tree, must be provided to avoid moist bark conditions and prevent decay.

Studies have shown that trees will establish more quickly and develop stronger trunk and root systems if they are not staked at the time of planting. Staking for support may be necessary only for top-heavy trees or at sites where vandalism or windy exposure are a concern.

If staking is necessary for support, two stakes used in conjunction with a wide flexible tie material will hold the tree upright, provide flexibility, and minimize injury to the trunk. To prevent damage to the root ball, stakes should be placed in undisturbed soil beyond the outer edges of the root ball. Perhaps the most important part of staking is its removal. Over time, guy wires (or other tie material) can cut into the growing trunk bark and interfere with the movement of water and nutrients within the tree. Staking material should be removed within 1 year of planting.

In areas in or adjacent to parks, natural areas, and open spaces where deer presence is evident and buck rub is a common problem resulting in significant preventable damage to newly planted trees, consider installation of deer protection fencing, as illustrated in Figure 3.48.



**Figure 3.48 Deer protection cage. (Adapted from Montgomery County, MD M-NCPPC).**

### 3.14.3 Tree Inspection Criteria

An initial inspection by a qualified professional must be done to ensure the tree has been planted, watered, and protected correctly with locations flagged if appropriate. New trees must have a species identification tag from the nursery to remain on two of each planted species at the time of final inspection. Tags shall be removed after inspection to prevent girdling. For newly planted trees, transplant shock is common and causes stress on the tree. For this reason, newly planted trees must be inspected more frequently than established trees. The time it takes for a tree to become established varies with the size at planting, species, stock, and site conditions, but generally, trees should be inspected every few months during the first 3 years after planting, to identify problems and implement repairs or modify maintenance strategies.

After the first 3 years, annual inspections are sufficient to check for problems. Trees must also be inspected after major storm events for any damage that may have occurred. The inspection should take only a few minutes per tree, but prompt action on any problems encountered results in healthier, stronger trees. Inspections should include an assessment of overall tree health, an assessment of survival rate of the species planted, cause of mortality, if maintenance is required, insect or disease problems, tree protection adjustment, and weed control condition.

DOEE's construction phase inspection checklist for tree planting and preservation can be found in Appendix L - Construction Inspection Checklists

### 3.14.4 Tree Maintenance Criteria

Water newly planted trees regularly (at least once a week) during the first growing season. Water trees less frequently (about once a month) during the next two growing seasons. After three growing seasons, water trees only during drought. The exact watering frequency will vary for each tree and site.

A general horticultural rule of thumb is that trees need 1 inch of rainfall per week during the growing season. This means new trees need a minimum of 25 gallons of water a week to stay alive (<http://caseytrees.org/get-involved/water/>). Water trees deeply and slowly near the roots. Light, frequent watering of the entire plant can actually encourage roots to grow at the surface. Soaker hoses and drip irrigation work best for deep watering of trees. It is recommended that slow leak watering bags or tree buckets are installed to make watering easier and more effective. Continue watering until mid-fall, tapering off during lower temperatures.

Pruning is usually not needed for newly planted trees but may be beneficial for tree structure. If necessary, prune only dead, diseased, broken or crossing branches at planting. As the tree grows, lower branches may be pruned to provide clearance above the ground, or to remove dead or damaged limbs.

DOEE's maintenance inspection checklist for tree planting and preservation and the Maintenance Service Completion Inspection form can be found in Appendix M - Maintenance Inspection Checklists.

**Declaration of Covenants.** A maintenance covenant is required for all stormwater management practices. The covenant specifies the property owner's primary maintenance responsibilities, and authorizes DOEE staff to access the property for inspection or corrective action in the event the proper maintenance is not performed. The covenant is recorded in the District of Columbia land records (see standard form, variations exist for scenarios where stormwater crosses property lines). A template form is provided at the end of Chapter 5 Administration of Stormwater Management Rules (see Figure 5.11), although variations will exist for scenarios where stormwater crosses property lines. The covenant is between the property and the Government of the District of Columbia. It is submitted through the Office of the Attorney General. All SWMPs have a maintenance agreement stamp that must be signed for a building permit to proceed. There may be a maintenance schedule on the drawings themselves or the plans may refer to the maintenance schedule (Exhibit C in the covenant).

Covenants are not required on government properties, but maintenance responsibilities must be defined through a partnership agreement or a memorandum of understanding.

**Waste Material.** Waste material from the repair, maintenance, or removal of a BMP or land cover shall be removed and disposed of in compliance with applicable federal and District law.

### 3.14.5 Tree Stormwater Compliance Calculations

Trees receive retention value but they are not accepted total suspended solids (TSS) treatment practices.

To ensure appropriate stormwater benefits associated with proposed tree preservation or planting, all trees receiving retention value must be properly maintained until redevelopment of

the area occurs. If trees die they must be replaced with a tree of similar mature spread no longer than 6 months from time of death in an appropriate location.

Preserved trees located within a site’s limits of disturbance (LOD) that meet the requirements described above receive a retention value of 10, 20, or 40 cubic feet each, depending upon the size of the mature spread of the tree and whether the tree is designated as Special or Heritage. Planted trees that meet the requirements described above receive a retention value of 5 or 10 cubic feet each, depending upon the size of the mature spread of the tree.

In order to receive the preserved tree retention value, trees must be left undisturbed in their original location. Only Special or Heritage trees can be moved and replanted and still be considered preserved trees. A licensed forester, an experienced forester, a licensed landscape architect, or a certified arborist must submit a tree transplant plan to DOEE and must comply with the "Tree Canopy Protection Amendment Act of 2016," D.C. Official Code § 8-651.01 *et seq.*

Note: Trees planted as part of another BMP, such as a bioretention area, also receive the 5 or 10 cubic foot retention value. Retention values are shown in Table 3-52 and Table 3-53 below.

**Table 3-52 Preserved Tree Retention Value and Pollutant Removal**

	Small Trees (average spread ≤ 40 feet)	Large Trees (average spread > 40 feet)	Special Trees (Between 44-inch and 99.9-inch circumference)	Heritage Trees (100-inch circumference or more)
Retention Value	= 10 ft <sup>3</sup> (75 gallons)	= 20 ft <sup>3</sup> (150 gallons)	= 30 ft <sup>3</sup> (225 gallons)	= 40 ft <sup>3</sup> (300 gallons)
Accepted TSS Treatment Practice	No	No	No	No

**Table 3-53 Planted Tree Retention Value and Pollutant Removal**

	Small Trees (average spread ≤ 40 feet)	Large Trees (average spread > 40 feet)
Retention Value	= 5 ft <sup>3</sup> (37.5 gallons)	= 10 ft <sup>3</sup> (75 gallons)
Accepted TSS Treatment Practice	No	No

Trees also contribute to peak flow reduction. This contribution can be determined in several ways. One method is to subtract the retention value from the total runoff volume for the 2-year, 15-year, and 100-year storms. The resulting reduced runoff volumes can then be used to calculate a reduced NRCS CN for the site or SDA. The reduced NRCS CN can then be used to calculate peak flow rates for the various storm events. Other hydrologic modeling tools that employ different procedures may be used as well.

### 3.14.6 References

- Alliance for the Chesapeake Bay (ACB). 2000. Pennsylvania Stream ReLeaf forest buffer toolkit. Harrisburg, PA: Pennsylvania Department of Environmental Protection.
- Arendt, R. G. 1996. Conservation design for subdivisions. A practical guide to creating open space networks. Washington, DC: Island Press. 184 p.
- Bassuk, N.; Curtis, D. F.; Marranca, B. Z.; Neal, B. 2003. Recommended urban trees: site assessment and tree selection for stress tolerance. Ithaca, NY: Cornell University, Urban Horticulture Institute. 127 p. <http://www.hort.cornell.edu/uhi/> (Accessed December 28, 2005).
- Buckstrup, M.; Bassuk, N. 2000. Transplanting success of balled-and-burlapped versus bare-root trees in the urban landscape. *Journal of Arboriculture* 26(6): 298-308.
- Cappiella, K.; Schueler, T.; Wright, T. 2006. Urban Watershed Forestry Manual. United States Department of Agriculture Forest Service. Newtown Square, PA.
- Caraco, D. 2000. Keeping soil in its place. In: Schueler, T.; Holland, H., eds. The practice of watershed protection. Ellicott City, MD; 323-328.
- Casey Trees. 2015. Urban Tree Selection Guide. Washington, DC. <https://issuu.com/caseytrees>
- Center for Watershed Protection. 1998. Better site design: a handbook for changing development rules in your community. Ellicott City, MD. 174 p.
- Cornell University. 2004. Conducting a street tree inventory. Ithaca, NY: Cornell University, Department of Horticulture. <http://www.hort.cornell.edu/commfor/inventory/index.html> (Accessed December 28, 2005).
- District of Columbia Department of Transportation. 2014. Green Infrastructure Standards. Washington DC. <https://ddot.dc.gov/sites/default/files/dc/sites/ddot/publication/attachments/2014-Final%20DDOT%20Green%20Infrastructure%20Standards.pdf>
- District of Columbia Department of Energy and Environment Natural Resources Administration. 2017. Green Area Ratio Guidebook. Washington, DC. [https://doee.dc.gov/sites/default/files/dc/sites/ddoe/service\\_content/attachments/GARGuidebook\\_FINAL\\_November2017\\_0.pdf](https://doee.dc.gov/sites/default/files/dc/sites/ddoe/service_content/attachments/GARGuidebook_FINAL_November2017_0.pdf)
- District of Columbia Department of Transportation. 2017. Erosion and Sediment Control Manual. Washington, DC. <https://doee.dc.gov/node/619312>
- Doherty, K.; Bloniarz, D.; Ryan, H. 2003. Positively the pits: successful strategies for sustainable streetscapes. *Tree Care Industry* 14(11): 34-42. <http://www.umass.edu/urbantree/publications/pits.pdf> (Accessed 2006).



- Flott, J. 2004. Proper planting begins below ground. *TreeLink* 19: 1-4.
- Georgia Forestry Commission (GFC). 2002. Community tree planting and establishment guidelines. Dry Branch, GA.
- Gilman, E. F. 1997. *Trees for urban and suburban landscapes*. Albany, NY: Delmar Publishers.
- Greenfeld, J.; Herson, L.; Karouna, N.; Bernstein, G. 1991. *Forest conservation manual: guidance for the conservation of Maryland's forests during land use changes, under the 1991 Forest Conservation Act*. Washington, DC: Metropolitan Washington Council of Governments. 122 p.
- Hairston-Strang, A. 2005. *Riparian forest buffer design and maintenance*. Annapolis: Maryland Department of Natural Resources. <http://dnr.maryland.gov/forests/Pages/publications.aspx>
- Head, C.; Robinson, F.; O'Brien, M. 2001. *Best management practices for community trees: a guide to tree conservation in Athens-Clarke County, Georgia*. Athens, GA: Athens-Clarke County Unified Government.
- International Society of Arboriculture (ISA). 2005. Avoiding excessive soil over the root systems of trees. *Arborist News*, April.
- International Society of Arboriculture (ISA). 2003a. Proper mulching techniques. Champaign, IL: International Society of Arboriculture. <http://treesaregood.org/portals/0/docs/treecare/ProperMulching.pdf> (Accessed 2006).
- International Society of Arboriculture (ISA). 2003b. *New tree planting*. Champaign, IL: International Society of Arboriculture.
- Johnson, G. R. 2005. *Protecting trees from construction damage: a homeowner's guide*. St. Paul, MN: Regents of the University of Minnesota. <http://www.extension.umn.edu/garden/yard-garden/trees-shrubs/protecting-trees-from-construction-damage/> (Accessed December 28, 2005).
- Kochanoff, S., 2002. *Trees vs. power lines: priorities and implications in Nova Scotia*. Presented at the 5th Annual Canadian Urban Forest Conference. Markham, ON.
- Maryland National Capital Parks and Planning Commission. 1992. *Trees. Approved Technical Manual*. Maryland National Capital Parks and Planning Commission, Montgomery County, MD. 144 p. [http://www.montgomeryplanning.org/environment/forest/trees/toc\\_trees.shtm](http://www.montgomeryplanning.org/environment/forest/trees/toc_trees.shtm)
- Meyer, D. 1993. *Tree shelters for seedling protection and increased growth*. Forestry Facts 59. Madison, WI: University of Wisconsin Extension.
- Minnesota Department of Natural Resources. 2000. *Conserving wooded areas in developing communities. BMPs in Minnesota*. Minnesota Department of Natural Resources, St. Paul, MN. 113 p. <http://www.dnr.state.mn.us/forestry/urban/bmps.html> (Accessed December 28, 2005).

- Morrow, S.; Smolen, M.; Stiegler, J.; Cole, J. 2002. Using vegetation for erosion control. *Landscape Architect* 18(11): 54-57.
- Nebraska Forest Service. 2004. Tree selection and placement. Storm Damage Bulletin No. 7. <http://digitalcommons.unl.edu/cgi/viewcontent.cgi?article=1068&context=nebforestpubs>
- Palone, R. S.; Todd, A. H., eds. 1998. Chesapeake Bay riparian handbook: a guide for establishing and maintaining riparian forest buffers. NA-TP-02-97. Radnor, PA: USDA Forest Service, Northeastern Area State and Private Forestry.
- Pennsylvania State University. 1999. A guide to preserving trees in development projects. University Park, PA: Penn State College of Agricultural Sciences, Cooperative Extension. 27 p.
- Pennsylvania State University (PSU). 1997. Questions about trees and utilities. Forestry Fact Sheet #7. University Park: Pennsylvania State University, College of Agricultural Sciences.
- Petit, J.; Bassert, D. L.; Kollin, C. 1995. Building greener neighborhoods. Trees as part of the plan. Washington, DC: American Forests and the National Association of Homebuilders.
- Schueler, T. R. 1995. Site planning for urban stream protection. Ellicott City, MD: Center for Watershed Protection. 232 p.
- Schueler, T.; Brown, K. 2004. Urban stream repair practices. Version 1.0. Manual 4 of the Urban Subwatershed Restoration Manual Series. Ellicott City, MD: Center for Watershed Protection.
- Sweeney, B. W. 1993. Effects of streamside vegetation on macroinvertebrate communities of White Clay Creek in Eastern North America. In: Proceedings of the Academy of Natural Sciences of Philadelphia. Philadelphia, PA; 291-340.
- Tree Care Industry Association (TCIA). 2004. ANSI A300 Standards for tree care operations. Manchester, NH; [https://www.tcia.org/TCIA/BUSINESS/ANSI\\_A300\\_Standards\\_/TCIA/BUSINESS/A300\\_Standards/A300\\_Standards.aspx?hkey=202ff566-4364-4686-b7c1-2a365af59669](https://www.tcia.org/TCIA/BUSINESS/ANSI_A300_Standards_/TCIA/BUSINESS/A300_Standards/A300_Standards.aspx?hkey=202ff566-4364-4686-b7c1-2a365af59669) (Accessed 2005).
- Trowbridge, P.; Bassuk, N. 2004. Trees in the urban landscape: site assessment, design, and installation. Hoboken, NJ: John Wiley & Sons, Inc.
- USDA Forest Service. 1998. Volunteer training manual. Amherst, MA: Northeast Center for Urban and Community Forestry. 86 p. <http://www.umass.edu/urbantree/volmanual.pdf> (Accessed December 28, 2005).
- Washington State Aquatic Habitat Guidelines Program (WSAHGP). 2002. Integrated streambank protection guidelines. Olympia, WA. Unpaginated.

# Chapter 4      **Selecting and Locating the Most Effective Stormwater Best Management Practice System**

## **4.1    Choosing Stormwater Management Best Practices (BMPs)**

This chapter outlines a general process for selecting appropriate best management practices (BMPs) at a development site. Guidelines are presented for choosing which BMPs can meet the retention and treatment volume targets for design storms and which BMPs are most feasible when various site constraints are present.

This chapter represents guidelines, not rules, to determine the most appropriate BMP for a site. It is important to note that certain BMP design modifications or specific site characteristics may allow for a particular BMP to become better suited at a particular location. Several of these design modifications are noted in the following tables and are described in more detail in the individual BMP specifications (see Chapter 3, “Stormwater Best Management Practices (BMPs)”).

The following questions organize a framework for decision making:

- **Regulatory Criteria**

*Can the BMP meet all stormwater sizing criteria at the site or are a combination of BMPs needed?*

- **Land Use Factors**

*Which practices are best suited for the proposed land use at this site?*

- **Physical Feasibility Factors**

*Are there any physical constraints at the project site that may restrict or preclude the use of a particular BMP?*

- **Community and Environmental Factors**

*Do the remaining BMPs have any important community or environmental benefits or drawbacks that might influence the selection process?*

- **Location and Permitting Considerations**

*What environmental features must be avoided or considered when locating the BMP system at a site to fully comply with District and federal regulations?*

## 4.2 Regulatory Compliance

Table 4-1 summarizes the capability of each BMP to meet the stormwater management sizing criteria outlined in Chapter 2, “Minimum Control Requirements.” Designers can use Table 4-1 to screen BMP options to determine whether a particular BMP can meet the SWR<sub>v</sub> storage, peak discharge ( $Q_{p2}$ ,  $Q_{p15}$ , and  $Q_f$ ), and pollutant removal requirements. Finding that a particular BMP cannot meet a requirement does not necessarily mean that it should be eliminated from consideration. This screening process can reduce BMP options to a manageable number and determine whether a single BMP or a group of BMPs will be needed to meet stormwater sizing criteria at the site.

The following are key considerations for compliance:

- **Stormwater Retention Volume (SWR<sub>v</sub>) Storage.** A single BMP may not be capable of meeting the SWR<sub>v</sub> requirement. This column can assist in identifying supplemental practices.
- **Quantity Control ( $Q_{p2}$ ,  $Q_{p15}$ , or  $Q_f$ ).** These columns show whether a BMP can typically meet the peak discharge requirements.
- **Pollutant Removal.** This column examines the capability of each BMP option to remove total suspended solids (TSS) from stormwater runoff.

Note: Table 4-1 should be used as a guide for how practices typically perform. Individual designs may be sized or designed with greater or lesser capabilities than are indicated in the table.

**Table 4-1 BMP Selection Based on Regulatory Criteria**

Code	BMP	SWR <sub>v</sub> Storage	Q <sub>p2</sub> /Q <sub>p15</sub> Control	Q <sub>r</sub> Control	TSS Removal
G-1	Extensive Green Roof	●	⊙	☒	Yes
G-2	Intensive Green Roof		⊙		
R-1	Rainwater Harvesting	⊙	⊙	☒	N/A
D-1	Simple Disconnection to a Pervious Area	⊙	☒	☒	No
D-2	Simple Disconnection to a Conservation Area				
D-3	Simple Disconnection to a Soil Compost Amended Filter Path				
P-1	Porous Asphalt	●	⊙	☒	Yes
P-2	Pervious Concrete				
P-3	Permeable Pavers				
B-1	Traditional Bioretention	●	⊙	☒	Yes
B-2	Streetscape Bioretention		⊙		
B-3	Engineered Tree Pits		⊙		
B-4	Stormwater Planters		⊙		
B-5	Residential Rain Gardens		⊙		
F-1	Nonstructural Sand Filter	☒	☒	☒	Yes
F-2	Surface Sand Filter				
F-3	Three-Chamber Underground Sand Filter				
F-4	Perimeter Sand Filter				
I-1	Infiltration Trench	●	⊙	☒	Yes
I-2	Infiltration Basin				
O-1	Grass Channels	⊙	☒	☒	No
O-2	Dry Swales/Bioswales	●			Yes
O-3	Wet Swales	☒			Yes
C-1	Micropool Extended Detention Pond	☒	●	●	Yes
C-2	Wet Pond				
C-3	Wet Extended Detention Pond				
W-1	Shallow Wetland	☒	●	●	Yes
W-2	Extended Detention Shallow Wetland				
S-1	Underground Detention Vaults and Tanks	☒	●	●	No
S-2	Dry Detention Ponds				
S-3	Rooftop Storage				
S-4	Stone Storage Under Permeable Pavement or Other BMPs				
M-1	Proprietary Practices	☒	☒	☒	Yes
T-1	Tree Preservation	⊙	☒	☒	No
T-2	Tree Planting				

● = Yes; ⊙ = Partial; ☒ = Minor or No Benefit

### 4.3 Land Use Factors

Designers can use Table 4-2 to evaluate BMPs that are best suited to a particular land use, including highly urbanized areas.

The following are key considerations for land use factors:

- **Residential.** This column identifies the best treatment options in medium to high density residential developments.
- **Commercial Development.** This column identifies practices that are suitable for new commercial development.
- **Roads and Highways.** This column identifies the best practices to treat runoff from major roadway and highway systems.
- **Hotspot Land Uses.** This column examines the capability of BMPs to treat runoff from designated hotspots. BMPs that receive hotspot runoff may have design restrictions, as noted.

**Table 4-2 BMP Selection Based on Land Use Screening Factors**

Code	BMP	Residential	Commercial	Roads and Highways	Hotspots
G-1	Extensive Green Roof	⊙	●	☒	☒
G-2	Intensive Green Roof				
R-1	Rainwater Harvesting	●	●	☒	☒
D-1	Simple Disconnection to a Pervious Area	●	●	⊙	☒
D-2	Simple Disconnection to a Conservation Area				
D-3	Simple Disconnection to a Soil Compost Amended Filter Path				
P-1	Porous Asphalt	⊙	●	①	☒
P-2	Pervious Concrete				
P-3	Permeable Pavers				
B-1	Traditional Bioretention	●	●	⊙	②
B-2	Streetscape Bioretention		●	●	
B-3	Engineered Tree Pits		●	●	
B-4	Stormwater Planters		●	☒	
B-5	Residential Rain Gardens		☒	☒	
F-1	Nonstructural Sand Filter	☒	●	●	●
F-2	Surface Sand Filter			⊙	
F-3	Three-Chamber Underground Sand Filter			⊙	
F-4	Perimeter Sand Filter			⊙	
I-1	Infiltration Trench	⊙	●	⊙	☒
I-2	Infiltration Basin				
O-1	Grass Channel	●	●	●	②
O-2	Dry Swale				
O-3	Wet Swale				
C-1	Micropool Extended Detention Pond	●	⊙	⊙	③

Code	BMP	Residential	Commercial	Roads and Highways	Hotspots
C-2	Wet Pond				
C-3	Wet Extended Detention Pond				
W-1	Shallow Wetland	●	●	⊙	③
W-2	Extended Detention Shallow Wetland				
S-1	Underground Detention Vaults and Tanks	☒	●	●	☒
S-2	Dry Detention Ponds	●	●	⊙	
S-3	Rooftop Storage	☒	●	☒	
S-4	Stone Storage Under Permeable Pavement or Other BMPs	●	●	●	
M-1	Proprietary Practices	●	●	●	●
T-1	Tree Preservation	●	●	●	●
T-2	Tree Planting				

● = Yes; ⊙ = Maybe; ☒ = No

①- Recommended for low volume roads or parking lanes

②-Yes, only if designed with an impermeable liner

③-May require pond liner to reduce the risk of groundwater contamination

#### 4.4 Physical Feasibility Factors

Typically, the designer narrows the BMP selection list based on regulatory goals and land use constraints before considering physical feasibility factors. Table 4-3 identifies the typical physical conditions needed for each type of BMP. Designers can use Table 4-3 to screen BMP options to determine whether the soils, water table, site drainage area (SDA), slope, or head conditions present at a particular development site might limit the use of a BMP. These factors are intended as guidelines rather than requirements.

The following are key considerations for physical feasibility:

- **Underlying Soils.** The designer should use NRCS hydrologic soils maps to generally identify expected soils and their locations at the site. More detailed geotechnical tests are required during BMP design to evaluate infiltration feasibility and related design parameters. Once the infiltration rate at a site has been measured, use this column and Table 4-4 to identify recommended design criteria for proposed BMPs that have an infiltration option.
- **Distance to Water Table.** Measure the depth of the groundwater and estimate the depth of the seasonally high water table (see Appendix P - Geotechnical Information Requirements for Underground BMPs). Use this column as an aid to determine recommended BMP sizing.
- **Contributing Drainage Area.** Delineate the contributing drainage area (CDA) to the proposed BMP, and use this column as an aid to determine the appropriate sizing factor. If the CDA present at a site is slightly greater than the maximum allowable CDA for a practice, some leeway is permitted. Likewise, the minimum CDAs indicated for ponds and stormwater wetlands should not be considered inflexible limits, and may be increased or decreased depending on water availability (baseflow or groundwater) or the mechanisms employed to prevent clogging or ensure an impermeable pond bottom.

- **Practice Surface Slope.** Evaluate the site topography. Determine the potential for cut and fill operations. Use this column as an aid to evaluate BMP surface slope restrictions. Specifically, the slope restrictions refer to how flat the area where the practice is installed must be.
- **Head.** To evaluate BMP options, determine the elevation of the discharge point, and use this column as an aid to estimate the elevation difference needed from the inflow to the outflow to allow for gravity operation.

**Table 4-3 BMP Selection Based on Physical Feasibility Screening Factors**

Code	BMP List	Underlying Soils	Distance to Water Table (ft)	Contributing Drainage Area (ac)	Practice Surface Slope (%)	Head (ft)
G-1	Extensive Green Roof	N/A	N/A	green roof surface area	1–2 <sup>a</sup>	N/A
G-2	Intensive Green Roof					
R-1	Rainwater Harvesting	N/A	N/A	no limit	N/A	N/A
D-1	Simple Disconnection to a Pervious Area	all soils	N/A	< 1,000 ft <sup>2</sup> per rooftop downspout <sup>b</sup>	< 5	N/A
D-2	Simple disconnection to a Conservation Area				< 6	
D-3	Simple Disconnection to a Soil Compost Amended Filter Path				< 5	
P-1	Porous Asphalt	all soils K <sub>sat</sub> < 0.5 in./hr may require underdrains)	2	2–5 × practice surface area	< 5	2–4
P-2	Pervious Concrete					
P-3	Permeable Pavers					
B-1	Traditional Bioretention	all soils (K <sub>sat</sub> < 0.5 in./hr may require underdrains)	2	< 2.5	< 1	4–5
B-2	Streetscape Bioretention			< 1		
B-3	Engineered Tree Pits			< 1		
B-4	Stormwater Planters			< 1		
B-5	Residential Rain Gardens			< 1		
F-1	Nonstructural Sand Filter	all soils	2	< 2	N/A	5
F-2	Surface Sand Filter			< 5		5
F-3	Three-Chamber Underground Sand Filter			< 2		5–10
F-4	Perimeter Sand Filter			< 2		2–3
I-1	Infiltration Trench	K <sub>sat</sub> > 0.5 in/hr is preferred	2	< 2	< 1	2
I-2	Infiltration Basin			< 5		
O-1	Grass Channel	all soils	2	< 2.5	< 4	1
O-2	Dry Swale	all soils (K <sub>sat</sub> < 0.5 in./hr may require underdrains)	2			3–5
O-3	Wet Swale	K <sub>sat</sub> < 0.5 in./hr	intersect WT			1
C-1	Micropool Extended Detention	soils K <sub>sat</sub> > 0.5	N/A	10–25	< 1	6–8



Code	BMP List	Underlying Soils	Distance to Water Table (ft)	Contributing Drainage Area (ac)	Practice Surface Slope (%)	Head (ft)
	Pond	in./hr may require pond liner				
C-2	Wet Pond		N/A	10–25		6–8
C-3	Wet Extended Detention Pond		N/A	10–25		6–8
W-1	Shallow Wetland	soils $K_{sat} > 0.5$ in./hr may require pond liner	N/A	$> 25^e$	$< 1$	2–4
W-2	Extended Detention Shallow Wetland		N/A			
S-1	Underground Detention Vaults and Tanks	all soils	no restrictions	no restrictions	$< 1$	$> 5$
S-2	Dry Detention Pond		2	$> 10^d$	$< 1$	6–8
S-3	Rooftop Storage		no restrictions	no limit	N/A	N/A
S-4	Stone Storage Under Permeable Pavement or Other BMPs		2	$< 2.5$	$< 1$	$> 5$
PP-1	Proprietary Practice	All soils	2	design dependent	N/A	2–5
TP-1	Tree Preservation	All soils	N/A	N/A	N/A	N/A
TP-2	Tree Planting		N/A	N/A		

Notes:  $K_{sat}$  = saturated hydraulic conductivity, WT = water table, N/A = not applicable

a Green roof slope can be up to 25% if baffles are used to ensure detention of the design storm.

b For impervious areas other than rooftop, the longest contributing impervious area flow path cannot exceed 75 feet.

c The required head for bioretention areas can be reduced in small applications or when an upturned or elevated underdrain design is used.

d No limit but practical CDA limitations may exist due to minimum orifice size (e.g., 1-inch diameter with internal orifice).

e CDA can be smaller if the practice intersects the water table.

**Table 4-4 Selection of Infiltration BMPs Based on Measured Saturated Hydraulic Conductivity**

Saturated Hydraulic Conductivity (in./hr)			
	$< 0.25$	$0.25-0.5$	$> 0.5$
<b>Recommended Design Solution</b>	Use Bioretention, Dry Swale, or Permeable Pavement (likely with an underdrain).  Do not use Infiltration Trench/Basin.	Use Bioretention, Dry Swale, or Permeable Pavement (likely with an underdrain). It may be beneficial to include an infiltration sump below the underdrain invert.  Infiltration Trench/Basin may not be appropriate.	Use Infiltration Trench/Basin, Bioretention, Dry Swale, or Permeable Pavement without an underdrain.

## 4.5 Community and Environmental Factors

Designers can use Table 4-5 to compare the BMP options with regard to maintenance, habitat, community acceptance, cost, safety, space consumption, and other environmental factors. Table 4-5 employs a comparative index approach to rank the benefits of community and environmental factors as high, medium, or low.

The following are key considerations for community and environmental factors:

- **Maintenance Burden.** This column identifies the relative maintenance effort needed for each BMP option, in terms of the frequency of scheduled maintenance, chronic maintenance problems (such as clogging), and reported failure rates. All BMPs require routine inspection and maintenance (see Appendix M - Maintenance Inspection Checklists).
- **Cost.** This column ranks BMPs according to their relative construction cost per cubic foot of stormwater retained, as determined from cost surveys and local experience.
- **Safety Risk.** This column provides a comparative index of the potential safety risks of each BMP option, when designed according to the performance criteria outlined in Chapter 3, “Stormwater Best Management Practices (BMPs)”. The index is included to highlight the need for considerations of liability and public safety in locations, such as residential, public space, schools, and others. A comparatively higher risk BMP may require signage, fencing, or other measures needed to alert the general public or maintenance provider of a potentially harmful situation.
- **Space Required.** This column provides a comparative index of the amount of space each BMP option typically consumes at a site. It may be helpful to consider this factor at an early stage of design because many urban BMPs are constrained by availability of open land.
- **Environmental Factors.** This column assesses the range of environmental factors considered under the Green Area Ratio (GAR) process to identify the broader human and environmental beneficial intersections some BMPs provide. For instance, some BMPs contribute to air quality improvements and reduce the urban heat island effect.
- **Habitat Value.** This column evaluates the ability of BMPs to provide wildlife or wetland habitat, assuming that an effort is made to landscape them appropriately. Objective criteria include size, water features, wetland features, and vegetative cover of the BMP and its buffer.
- **Other Factors.** This column indicates other considerations in BMP selection.

**Table 4-5 BMP Selection Based on Community and Environmental Factors**

Code	BMP List	Maintenance Burden	Cost*	Safety Risk	Space Required	Environmental Benefits	Habitat Value	Other Factors
G-1	Extensive Green Roof	L	H	L	L	H	L	Increases structural loading on building
G-2	Intensive Green Roof	M	H				M	
R-1	Rainwater Harvesting	L	M	L	L	H	L	
D-1	Simple Disconnection to a Pervious Area							
D-2	Simple Disconnection to a Conservation Area	L	L	L	M	M	L	
D-3	Simple Disconnection to a Soil Compost Amended Filter Path							
P-1	Porous Asphalt							
P-2	Pervious Concrete	H	H	L	L	M	L	
P-3	Permeable Pavers							
B-1	Traditional Bioretention	M	L		M		M	Can be used as landscaping features
B-2	Streetscape Bioretention	H	H		M		M	
B-3	Engineered Tree Pits	M	H	L	L	H	M	
B-4	Stormwater Planters	L	M		L		L	
B-5	Residential Rain Gardens	L	L		L		M	
F-1	Nonstructural Sand Filter	M	L	L	M			Minimize concrete
F-2	Surface Sand Filter	H	M	M	L			Minimize concrete
F-3	Three-Chamber Underground Sand Filter	H	H	M	L	L	L	Out of sight
F-4	Perimeter Sand Filter	M	M	L	M			Traffic bearing
I-1	Infiltration Trench							Avoid large stone
I-2	Infiltration Basin	L	M	L	M	L	L	Frequent pooling

Notes: H = High; M = Medium; L=Low  
 \* Cost based on \$ per cubic foot of stormwater treated

Code	BMP List	Maintenance Burden	Cost*	Safety Risk	Space Required	Environmental Benefits	Habitat Value	Other Factors
O-1	Grass Channel	M	L				L	
O-2	Dry Swale	H	M	L	M	M	L	
O-3	Wet Swale	H	M				M	Possible mosquitoes
C-1	Micropool Extended Detention Pond	M					L	Trash/debris
C-2	Wet Pond	H	L	M	H	M	H	High pond premium
C-3	Wet Extended Detention Pond	H					H	
W-1	Shallow Wetland	M	M	L	H	H	H	
W-2	Extended Detention Shallow Wetland			M				Limit ED depth
S-1	Underground Detention Vaults and Tanks		H		L	L		Out of sight
S-2	Dry Detention Pond	M	L	M	H	M		
S-3	Rooftop Storage		L		L	L	L	
S-4	Stone Storage Under Permeable Pavement or Other BMPs		L		L	M		

Notes: H = High; M = Medium; L=Low  
 \* Cost based on \$ per cubic foot of stormwater treated

## 4.6 Location and Permitting Considerations

In this step, the designer follows an environmental features checklist that asks whether any of the following are present at the site: wetlands, surface waters, floodplains, and development infrastructure. Brief guidance is then provided on how to locate BMPs to avoid impacts to sensitive resources.

In the last step, a designer assesses the physical and environmental features at the site to determine the optimal location for the selected BMP or group of BMPs (Table 4-5). The checklist below (Table 4-6) provides a condensed summary on current BMP restrictions as they relate to common site features that may be regulated under District or federal law. These restrictions fall into one of three general categories:

1. Locating a BMP within an area that is expressly *prohibited* by law.
2. Locating a BMP within an area that is *strongly discouraged* and is only allowed on a case by case basis. District and/or federal permits shall be obtained, and the applicant will need to supply additional documentation to justify locating the BMP within the regulated area.
3. BMPs must be *set back* a fixed distance from the site feature.

This checklist is only intended as a general guide to location and permitting requirements as they relate to siting of stormwater BMPs. Consultation with the appropriate regulatory agency is the best strategy.

**Table 4-6 Location and Permitting Considerations**

Site Features and Relevant Agencies	Location and Permitting Guidance
<p><b>Wetland</b></p> <p>U.S. Army Corps of Engineers Section 404 Permit</p> <p>Section 401 Water Quality Certification</p>	<ul style="list-style-type: none"> <li>▪ Delineate wetlands prior to locating BMPs.</li> <li>▪ Use of natural wetlands for stormwater management is <i>strongly discouraged</i>.</li> <li>▪ BMPs are also <i>restricted</i> in the 25- to 100-foot required wetland buffer.</li> <li>▪ Buffers may be utilized as a nonstructural filter strip (i.e., accept sheetflow).</li> <li>▪ Must justify that no practical upland treatment alternatives exist.</li> <li>▪ Stormwater must be treated to meet the District’s water quality standards prior to discharge into a wetland.</li> <li>▪ Where practical, excess stormwater flows should be conveyed away from jurisdictional and isolated wetlands.</li> </ul>
<p><b>Stream Channel</b> (Waters of the U.S.)</p> <p>U.S. Army Corps of Engineers Section 404 Permit</p>	<ul style="list-style-type: none"> <li>▪ Delineate stream channels prior to design.</li> <li>▪ In-stream ponds (should be located near the origin of first order streams) are <i>strongly discouraged</i> and require review and permit.               <ul style="list-style-type: none"> <li>○ Must justify that no practical upland treatment alternatives exist.</li> <li>○ Temporary runoff storage (peak flow management) is preferred over permanent pools.</li> <li>○ Implement measures that reduce downstream warming.</li> </ul> </li> </ul>

Site Features and Relevant Agencies	Location and Permitting Guidance
<p><b>100 Year Floodplain</b></p> <p>District of Columbia Homeland Security and Emergency Management Agency</p> <p>Department of Energy and Environment</p>	<ul style="list-style-type: none"> <li>▪ When other on-site locations are available, DOEE discourages construction of BMPs in the floodplain because they may require more intensive maintenance.</li> <li>▪ Significant grading and fill for BMP construction within the 100-year floodplain, as delineated by FEMA Flood Insurance Rate Maps (FIRM) may be restricted with respect to impacts on surface elevation (Title 20 of the District of Columbia Municipal Regulations, Chapter 31 Flood Hazard Rules).</li> </ul>
<p><b>Utilities</b></p>	<ul style="list-style-type: none"> <li>▪ Locate existing utilities prior to design.</li> <li>▪ Note the location of proposed utilities to serve new construction.</li> <li>▪ Consult with each Utility on their recommended offsets</li> <li>▪ Consider altering the location or sizing of the BMP to avoid or minimize the utility conflict. Consider an alternate BMP type to avoid conflict.</li> <li>▪ Use design features to mitigate the impacts of conflicts that may arise by allowing the BMP and the utility to coexist. The BMP design may need to incorporate impervious areas, through geotextiles or compaction, to protect utility crossings. Or a key design feature may need to be moved or added or deleted.</li> <li>▪ Coordinate with Utilities to allow them to replace or relocate their aging infrastructure during construction.</li> <li>▪ If utility functionality, longevity, and vehicular access to manholes can be assured, accept the BMP design and location with the existing utility. Incorporate into the BMP design sufficient soil coverage over the utility or general clearances or other features such as an impermeable linear to assure all entities the conflict is limited to maintenance.</li> <li>▪ When accepting utility conflict into BMP design, it is understood that the BMP will be temporarily impacted during utility work but the utility will replace the BMP or, alternatively, install a functionally comparable BMP according to the specifications in the current version of this guidebook. If the BMP is located in the public right-of-way the BMP restoration will also conform with the District of Columbia Department of Transportation Design and Engineering Manual with special attention to Chapter 28 and the Design and Engineering Manual supplements for Low Impact Development and Green Infrastructure Standards and Specifications.</li> </ul>
<p><b>Public Right-of-Way (PROW)</b></p> <p>District Department of Transportation</p>	<ul style="list-style-type: none"> <li>▪ BMP installation in PROW will require a DDOT Public Space Permit.</li> <li>▪ Consult DDOT for guidance on placement and any setback requirement from local roads.</li> </ul>

Site Features and Relevant Agencies	Location and Permitting Guidance
<p><b>Structures</b></p> <p>District Department of Transportation</p> <p>District of Columbia Water and Sewer Authority</p> <p>Department of Consumer and Regulatory Affairs</p>	<ul style="list-style-type: none"> <li>▪ Consult review authority for BMP setbacks from structures.</li> <li>▪ Recommended setbacks for each BMP group are provided in the performance criteria in Chapter 3, “Stormwater Best Management Practices (BMPs).”</li> </ul>

## 4.7 References

Galli, John. 1992. Analysis of Urban BMP Performance and Longevity in Prince George's County, Maryland. Prepared for Prince George's County Department of Environmental Resources Watershed Protection Branch. Prepared by Metropolitan Washington Council of Governments, Department of Environmental Programs. Washington DC.





# Chapter 5 Administration of Stormwater Management Rules

## 5.1 Administration

### 5.1.1 Approval Requirements

Before the District of Columbia Department of Consumer and Regulatory Affairs (DCRA) may issue a building permit for any project requiring stormwater management, as described in Chapter 2, “Minimum Control Requirements” of this guidebook, the Department of Energy and Environment (DOEE) must approve a Stormwater Management Plan (SWMP) meeting the requirements of the Stormwater Management and Soil Erosion and Sediment Control Regulations (District of Columbia Municipal Regulations (DCMR) Title 21, Chapter 5).

For all major regulated projects and projects for the generation of Stormwater Retention Credits (SRCs), the applicant is responsible for submitting a SWMP that meets the requirements of this guidebook and of 21 DCMR, Chapter 5. Each SWMP must be signed and sealed by a registered professional engineer licensed in the District. All SWMP applications are reviewed by DOEE to determine compliance with the requirements of 21 DCMR, Chapter 5.

Some projects may also require an Environmental Intake Screening Form (EISF). This can be determined using DCRA’s Environmental Intake Form (EIF). The EISF review process occurs concurrently with DOEE’s SWMP review process. Both the EISF and EIF are available at <https://dcra.dc.gov/service/permits-environmental-review>. If the EISF is required, SWMP approval will not be granted until after EISF approval.

### 5.1.2 Fees

An applicant is responsible for paying fees that provide for the cost of review, administration, and management of the stormwater permitting process and inspection of all projects subject to the requirements of 21 DCMR, Chapter 5, Sections 516 through 539. These fees are posted on DOEE’s website at <https://doee.dc.gov/swregs> within several tables and can be found in 21 DCMR, Chapter 5, Section 501. The fees are adjusted for inflation annually, using the Urban Consumer Price Index published by the United States Bureau of Labor Statistics.

DOEE charges review fees for all projects including major regulated projects, projects for the generation of SRCs, and projects requiring review for soil erosion and sediment control or Green Area Ratio. Refer to Figure 5.1 to determine when DOEE will charge review fees.

Note: A supplemental plan review fee is required for each DOEE review after first resubmission of a plan or for revisions to a plan after plan approval. Phased review requirements that follow the maximum extent practicable (MEP) process (see Appendix B - Maximum Extent Practicable

Process for Existing Public Right-of-Way) for a project, or portion of a project, entirely in the existing public right-of-way (PROW) are not required to pay a supplemental review fee.

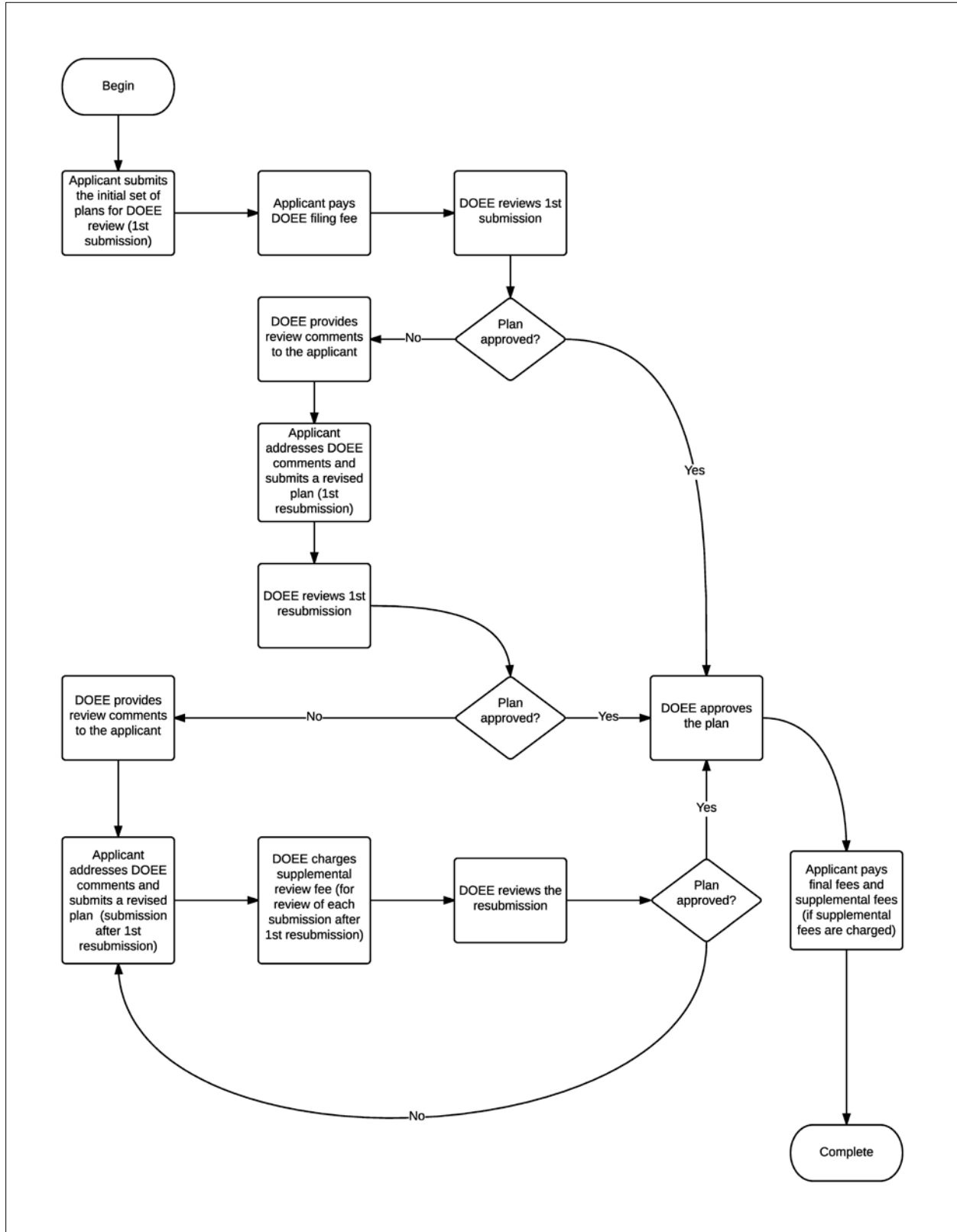


Figure 5.1 Fees.

## 5.2 Stormwater Management Plans

### 5.2.1 Submittal and Review Process of Stormwater Management Plans

A series of flow charts illustrate the SWMP review and approval process within the overall context of the permitting process (see Figure 5.2 and Figure 5.3). This process includes use of DOEE's Stormwater Database for submittal and review.

An SWMP contains supporting computations, drawings, and sufficient information to evaluate the environmental characteristics of the affected areas, the potential impacts of the proposed development on water resources, the effectiveness and acceptability of stormwater best management practices (BMPs), and land covers for managing stormwater runoff and maintenance and construction schedules.

All SWMPs must include the Required Plan Compliance Sheet from DOEE's Stormwater Database. This includes the calculated Stormwater Retention Volume (SWRV) as well as any SRC eligibility or Off-Site Retention Volume (Offv) obligation. When submitting the SWMP for review, the applicant must submit compliance information online through the Stormwater Database. Additional information on this process is available in Appendix A - Compliance Calculations and Design Examples and online at <https://doee.dc.gov/swdb>.

The applicant must upload one complete electronic set of the SWMP, certified by a professional engineer licensed in the District of Columbia, to the Stormwater Database. The applicant must also upload each supporting document listed in this chapter. If requested by DOEE's reviewer, the applicant must also provide one paper set of the SWMP, certified by a professional engineer licensed in the District of Columbia. Submit paper copies at the DCRA headquarters at 1100 4th Street SW, Second Floor.

Some submittals, including applications that are limited to Soil Erosion and Sediment Control Plans, may only require review by DOEE staff located at the DCRA intake counter. All other projects will be forwarded for review to DOEE Headquarters at 1200 First Street NE, Fifth Floor. Other District agencies with review authority will also evaluate a project's SWMP.

Upon receiving an application, DOEE will determine if it is complete and acceptable for review, accept it for review with conditions, or reject it. DOEE will not begin to review an SWMP until the applicant has paid filing fees.

Within 10 to 30 working days of accepting an application as complete (which includes payment of filing fees), DOEE will review the SWMP and make a determination to approve, approve with conditions, or disapprove the SWMP. Relatively large and/or complicated projects tend to require longer review time than smaller and less complicated projects.

If it is determined that more information is needed or that a significant number of changes must be made before the SWMP can be approved, the applicant may withdraw the SWMP, make the necessary changes, and resubmit the SWMP. The applicant must update any information in the

Stormwater Database that has been changed and include a new Required Plan Compliance Sheet as part of the SWMP. DOEE requires that all resubmissions contain a list of the changes made. A new 10- to 30-day review period begins on the date of the resubmission.

If SWMP approval is denied, the reasons for the denial will be communicated to the applicant in writing.

When an SWMP approval is granted, a final submission package is required, including

- One PDF copy of the SWMP, certified by a registered professional engineer licensed in the District of Columbia, uploaded to the Stormwater Database per DOEE requirements.
- A declaration of covenants that has been approved for legal sufficiency by the Office of the Attorney General (OAG). Government properties are exempt from this requirement but evidence of a maintenance partnership agreement or a maintenance memorandum of understanding is required prior to SWMP approval. Five additional types of SWMP submissions are not required to file a declaration of covenants, nor are they required to file easements. These are detailed in Section 2.12, “Exemptions.”
- All supporting documents specified within this guidebook or as requested during the review process must be uploaded to the Stormwater Database, per DOEE requirements.

Note: DOEE may adopt an alternate format for these documents.

After the applicant submits a final package, DOEE will review the declaration of covenants for technical sufficiency. If the final package meets the requirements for DOEE’s approval, DOEE will approve the declaration of covenants and provide it to the applicant for recording. The applicant must submit proof of filing the declaration of covenants (or evidence of a maintenance partnership agreement or a maintenance memorandum of understanding in the case of a government owned project) and each applicable easement with the Recorder of Deeds, and proof of payment of applicable fee(s) for DOEE services. After submission of proof of filing and payment, the approved SWMP is available to the applicant via the Stormwater Database.

DOEE approval of an SWMP will expire if the building permit or building permit application expires, with the exception of approvals for federal projects that are not required to obtain a building permit, in which case the SWMP will not expire unless the performance requirements of 21 DCMR, Chapter 5 change.

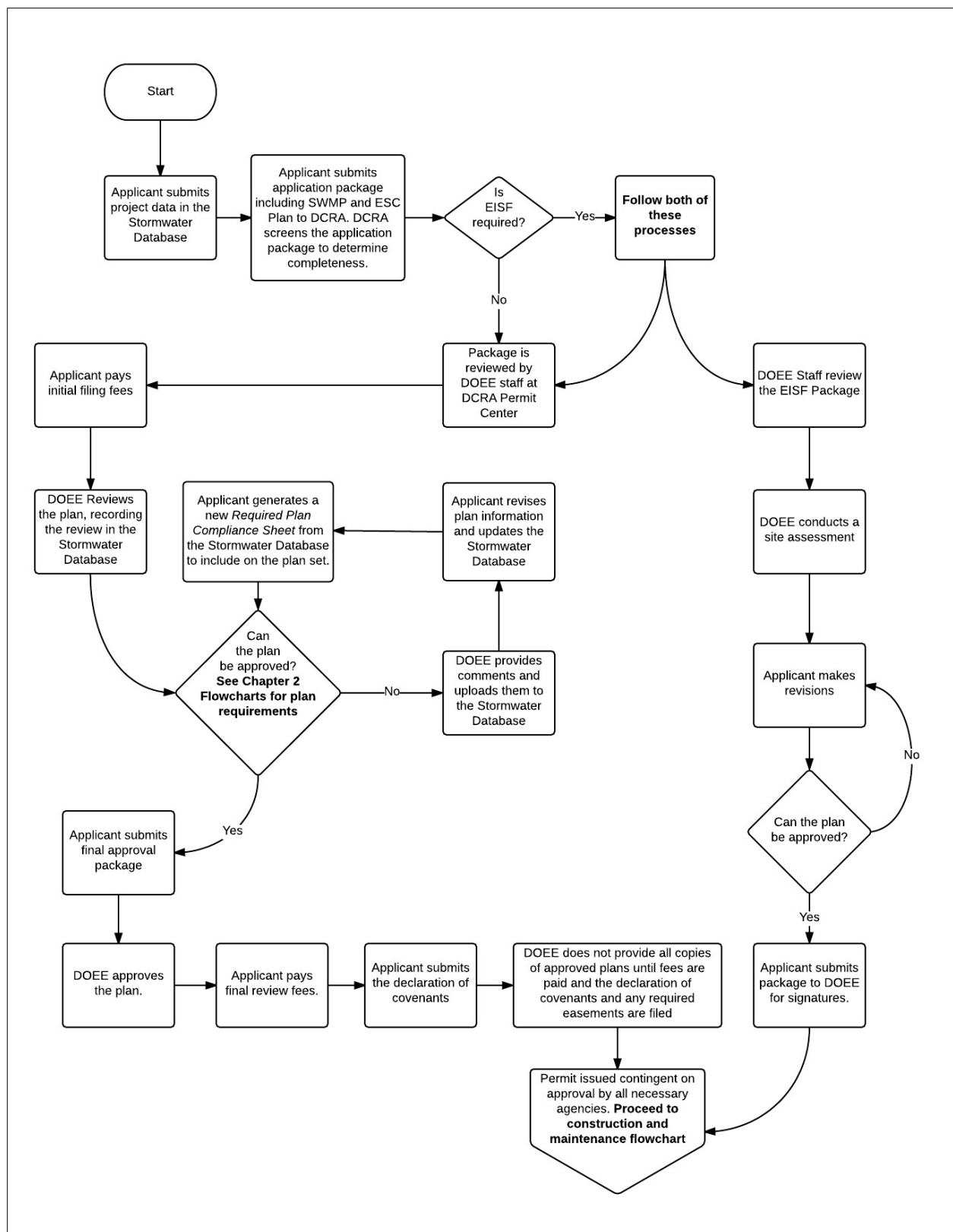


Figure 5.2 Plan review process.

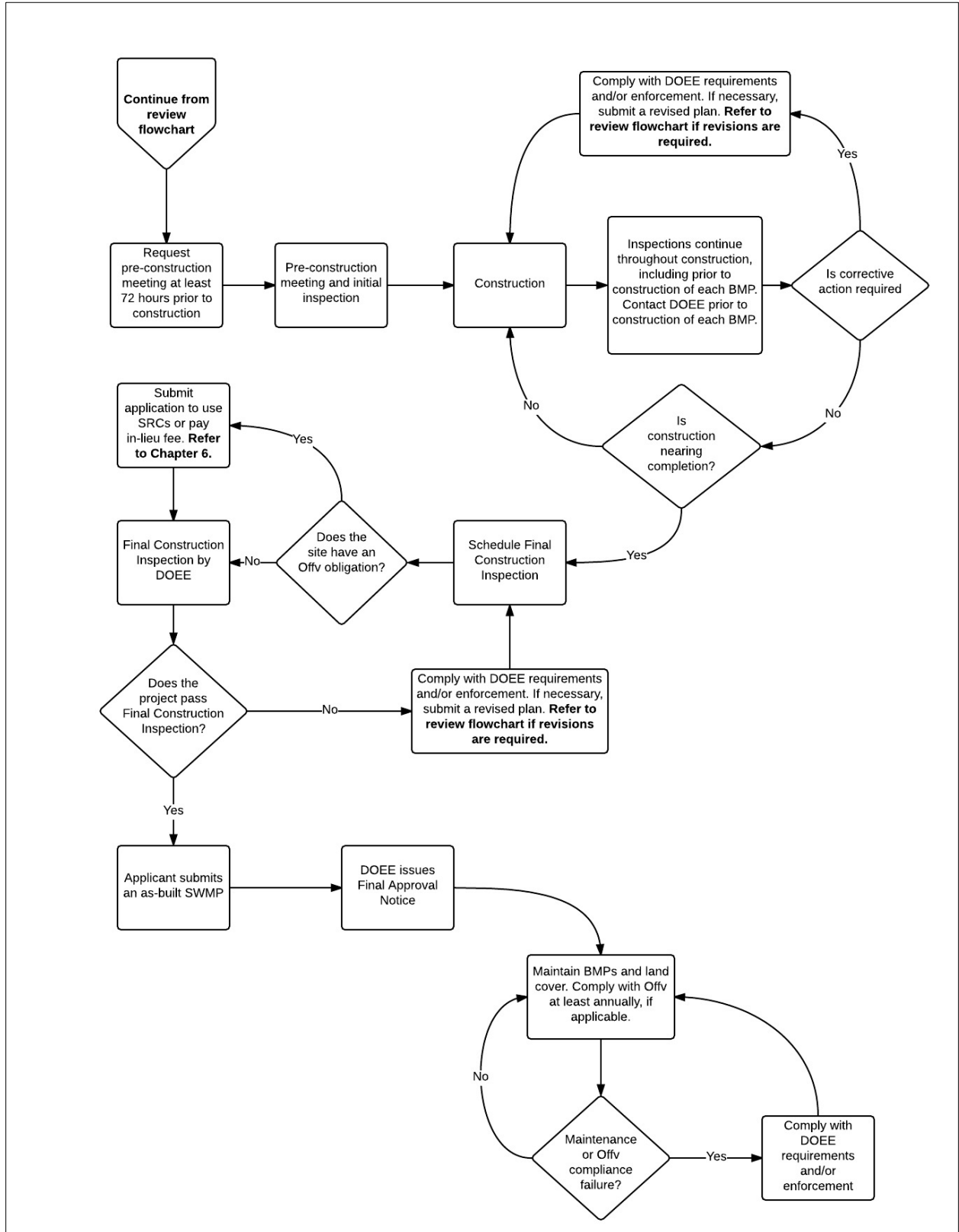


Figure 5.3 Construction inspection and maintenance process.

### 5.2.2 SWMP Submittal Documents

The submission of an SWMP is supported by these documents, as applicable:

- DC Water/DOEE Storm Sewer Verification Form
- As-Built Certification by Professional Engineer Form
- Statement By Professional Engineer Registered In the District of Columbia Form
- Statement By Person Responsible For Maintenance Form
- Statement By Person Responsible For Achieving Off-Site Retention Form
- Anacostia Waterfront Development Zone Site Form
- Application for Vesting Status
- Declaration of Covenants Template
- Environmental Intake Form (EIF)
- Environmental Intake Screening Form (EISF)
- Environmental Questionnaire
- DCRA Flood Hazard Development Form

Forms not available in Section 5.6, “Supporting Forms” are available at the DCRA intake counter, or may be downloaded at <https://dcra.dc.gov/node/1245331>. Note: In general, filing a Notice of Intent with the US Environmental Protection Agency (EPA) is required if the project will disturb one or more acres of land or is part of a common plan of development or sale that will ultimately disturb one or more acres of land. Consult EPA’s web site for details: <https://www.epa.gov/npdes/2017-construction-general-permit-cgp>

### 5.2.3 SWMP Components

A SWMP includes the following:

#### Site Plan

The following information must be submitted on a standard drawing size of 24 by 36 inches. The site drawing will provide details of existing and proposed conditions:

1. A cover page that contains a blank space measuring 7 inches wide by 9.5 inches high. The blank space must be located 1 inch below the top edge and 1 inch from the left edge of the page;
2. A plan showing property boundaries and the complete address of the property;
3. Lot number, square number, or parcel number designation (if applicable);
4. North arrow, scale, and date;



5. Property lines (include longitude and latitude);
6. Location of easements (if applicable);
7. Existing and proposed structures, utilities, roads, and other paved areas;
8. Existing and proposed topographic contours;
9. Soil information for design purposes;
10. Area(s) of soil disturbance;
11. Volume(s) of excavation;
12. Volume(s) of fill;
13. Volume(s) of backfill;
14. Site drainage area(s) (SDAs) within the limits of disturbance (LOD) and contributing to the LOD
15. Contributing drainage area (CDA) to each BMP;
16. Location(s) of BMPs, marked with the BMP ID Numbers assigned by the Stormwater Database;
17. Delineation of existing and proposed land covers including natural cover, compacted cover, and impervious surfaces. Consult Appendix O - Land Cover Designations;
18. Location of existing stream(s), wetlands, or other natural features within the project area;
19. All plans and profiles must be drawn at a scale of 1 in. = 10 ft, 1 in. = 20 ft, 1 in. = 30 ft, 1 in. = 40 ft, 1 in. = 50 ft, or 1 in. = 80 ft. Although, 1 in. = 10 ft, 1 in. = 20 ft, and 1 in. = 30 ft, are the most commonly used scales. Vertical scale for profiles must be 1 in. = 2 ft, 1 in. = 4 ft, 1 in. = 5 ft, or 1 in. = 10 ft;
20. Drafting media that yield first- or second-generation, reproducible drawings with a minimum letter size of No. 4 (1/8 inch);
21. Location and size of existing utility lines including gas lines, sanitary lines, telephone lines or poles, and water mains;
22. A legend identifying all symbols used on the plan;
23. Applicable flood boundaries for sites lying wholly or partially within the 100-year floodplain;
24. Information regarding the mitigation of any off-site impacts anticipated as a result of the proposed development;
25. Stormwater Pollution Prevention Plan (SWPPP) (for projects disturbing over an acre) or Good Housekeeping Stamp, details provided in Appendix R - Pollution Prevention Through Good Housekeeping;
26. Stormwater Hotspot Cover Sheet and Checklists, details provided in Appendix Q - Stormwater Hotspots;

27. Integrated Pest Management Plan (IPM) for sites in the AWDZ governed by the by the Anacostia Waterfront Environmental Standards Amendment Act of 2012. Consult Appendix S - Integrated Pest Management for details on the IPM plan submission format;
28. Construction specifications;
29. Design and As-Built Certification, including the following:
  - a. Certification by a registered professional engineer licensed in the District that the site design, land covers, and design of the BMPs conforms to engineering principles applicable to the treatment and disposal of stormwater pollutants; and
  - b. Certification and submission of the As-Built Certification by Professional Engineer form (provided in at the end of this chapter) and one set of the as-built plans within 21 days after completion of construction of the site, all BMPs, land covers, and stormwater conveyances. For a project consisting entirely of work in the PROW, the submission of a Record Drawing certified by an officer of the project contracting company is acceptable if it details the as-built construction of the BMP and related stormwater infrastructure;
30. Maintenance of stormwater BMPs, including the following:
  - a. A maintenance plan that identifies routine and long-term maintenance needs and a maintenance schedule;
  - b. For major regulated projects, a declaration of covenants stating the owner's specific maintenance responsibilities identified in the maintenance plan and maintenance schedule. These must be exhibits recorded at the Recorder of Deeds. An example of a declaration of covenants is provided at the end of this chapter. Though government-owned properties are exempt from the declaration of covenants requirement, long-term maintenance obligations are the same as for any other regulated site; and
  - c. For applicants using BMP Group 2, Rainwater Harvesting, submission of third-party testing of end-use water quality may be required at equipment commissioning as determined by the requirements in Appendix N - Rainwater Harvesting Treatment and Management Requirements. Additional regular water quality reports certifying compliance for the life of the BMP may also be required in Appendix N - Rainwater Harvesting Treatment and Management Requirements.

### **Stormwater Retention Volume Computations**

The following calculations must be included on the plan set. Many of these calculations are included on the Required Plan Compliance Sheet from the Stormwater Database, which must be incorporated in the plan set.

1. Calculation(s) of the required SWR<sub>v</sub> for the entire site within the LOD and each SDA within the LOD;

2. Calculation(s) of the required Water Quality Treatment Volume (WQTV) for AWDZ sites for the entire site within the LOD and each SDA within the LOD;
3. Calculation(s) for each proposed BMP demonstrating retention value towards SWRV in accordance with Chapter 3 Stormwater Best Management Practices (BMPs);
4. For BMP Group 2, Rainwater Harvesting, calculations demonstrating the annual water balance between collection, storage, and demand, as determined using the Rainwater Harvesting Retention Calculator;
5. For proprietary and non-proprietary BMPs outside the Stormwater Management Guidebook, complete documentation defined in Appendix T - Proprietary Practices Approval Process for BMP Group 12, Proprietary Practices, in Section 3.13, "Proprietary Practices" to identify/receive approval or denial to use these practice(s);
6. Offv requirement and/or SRC eligibility;
7. For PROW projects (Type 1), complete the MEP stormwater report as defined in Appendix B - Maximum Extent Practicable Process for Existing Public Right-of-Way; and
8. For PROW portions of projects (Type 2), complete the MEP memo with supporting documentation as defined in Appendix B - Maximum Extent Practicable Process for Existing Public Right-of-Way.

### **Pre- and Post-Development Hydrologic Computations**

The pre- and post-development runoff analysis must include the following:

1. A summary of soil conditions and field data;
2. Pre- and post-project curve number computation;
3. Time of concentration calculation;
4. Travel time calculation; and
5. Peak discharge computation for each SDA within the project's LOD for the 24-hour storms of 2-year and 15-year frequencies. All hydrologic computations must be included on the plan.

### **Hydraulic Computations**

Hydraulic computations for the final design of water quality and quantity control structures may be accomplished by hand or through the use of software using equations/formulae generally accepted in the water resources industry. The summary of collection or management systems will include the following:

1. Existing and proposed SDA must be delineated on separate plans with the flow paths used for calculation of the times of concentration;
2. Hydraulic capacity and flow velocity for drainage conveyances, including ditches, swales, pipes, inlets, and gutters. Plan profiles for all open conveyances and pipelines, with energy and hydraulic gradients shown thereon;

3. The proposed development layout including the following:
4. Location and design of BMP(s) on site, marked with the BMP ID Numbers assigned by the Stormwater Database;
5. Stormwater lines and inlets;
6. A list of design assumptions (e.g., design basis, 15-year return period);
7. The boundary of the CDA to the BMP;
8. Schedule of structures (a listing of the structures, details, or elevations including inverts); and
9. Manhole to manhole listing of pipe size, pipe type, slope, computed velocity, and computed flow rate (i.e., a storm drain pipe schedule).

#### **5.2.4 Resubmission of Stormwater Management Plans**

If changes occur in the design or construction of an accepted SWMP, the applicant may be required to resubmit the SWMP for approval. Examples of changes during design and construction that will require SWMP resubmission for review include the following:

1. Revision to the property boundary, property size, or LOD boundaries that may require redesigning BMPs
2. Any change to SWRv through land cover designation change
3. Change in compaction or infiltration rates due to construction activities
4. Encountering contaminated soil or other underground source of contamination
5. Changes to floodplain designation or requirements
6. Changes in any component of the BMP that may adversely affect the intended capacity of the approved BMP, such as the following:
  - a. Modification to approved BMP selection, dimensions, or location
  - b. Modification to approved material specification
  - c. Changes to the size, invert, elevation, and slopes of pipes and conveyances
  - d. Installation of new drains and conveyance structures
  - e. Need for a new storm sewer outlet connection to the sanitary/storm sewer main
  - f. Changes to the amount of off-site requirements
  - g. Changes to the CDA to a BMP
7. Revision to the approved grading and drainage divides and that may require redesigning BMPs
8. Relocation of an on-site storm sewer or conveyance
9. Abandonment, removal, or demolition of a BMP

If the applicant resubmits an SWMP after making changes, the resubmission must contain a list of the changes made. The applicant must update any information in the Stormwater Database that has been changed and place a new Required Plan Compliance Sheet on the plan set. The

applicant may also need to update and resubmit the declaration of covenants. After DOEE's initial review and its review of the first resubmission, an applicant will pay the supplemental review fee for each subsequent review. This includes review for revisions to plans after plan approval. Supplemental fees will not be assessed when a submission is for a project, or portion of a project, that is entirely in the existing PROW and is following the MEP process (see Appendix B - Maximum Extent Practicable Process for Existing Public Right-of-Way).

If any of the following minor changes are made to the SWMP, resubmission is not required. A DOEE inspector may approve these minor changes at anytime during inspection or at the as-built submittal by a DOEE inspector.

1. Changes to SWM components that do not adversely affect BMP capacity while in consultation with the review engineer. The inspector should review the appropriate manufacturer's documentation to his/her satisfaction before approving such a change and should ensure that such changes are recorded as red line changes or deviations in the as-built plans. These changes include the following:
  - a. Changes to part manufacturer of similar function (e.g. dewatering valve from one manufacturer to another)
  - b. Change in hole pattern or size of underdrain pipe perforations
2. Change in project address, ownership, permit status, or zoning

For resubmissions of the Erosion and Sediment Control Plan, refer to the DOEE website <https://doee.dc.gov/esc> for further information.

## **5.3 Construction Inspection Requirements**

### **5.3.1 Inspection Schedule and Reports**

Prior to the approval of an SWMP, the applicant will submit a proposed construction inspection schedule. DOEE will review the schedule to determine if changes are required. The construction schedule should reflect the construction sequences defined in each BMP section of Chapter 3 Stormwater Best Management Practices (BMPs) of this guidebook. The construction and inspection schedule must be included in the SWMP. DOEE will conduct inspections at the specified construction stages, and file reports of inspections during construction of BMPs and site stormwater conveyance systems to ensure compliance with the approved plans.

Note: No stormwater management work may proceed past the stage of construction that DOEE has identified as requiring an inspection unless

- DOEE has issued an "approved" or "passed" report;
- DOEE has approved a plan modification that eliminates the inspection requirement; or
- DOEE has eliminated or modified the inspection requirement in writing.

DOEE may require that the professional engineer responsible for sealing the approved SWMP, the professional engineer responsible for certifying the as-built SWMP, or, for a project entirely

in the PROW, the officer of the contracting company responsible for certifying the Record Drawing be present during inspections.

If DOEE conducts an inspection and finds work that is not in compliance with the SWMP, DOEE may issue a written notice requiring the applicant to take prompt corrective action. The written notice provides details on the nature of corrections required and the time frame within which corrections must be made. DOEE may also take other enforcement action as authorized by District of Columbia law and 21 DCMR, Chapter 5.

### **5.3.2 Inspection Requirements Before and During Construction**

DOEE's construction inspection checklists for each BMP are provided in Appendix L - Construction Inspection Checklists.

**Preconstruction Meetings.** These meetings are required prior to the commencement of any land-disturbing activities and prior to the construction of any BMPs. The applicant is required to contact DOEE to schedule preconstruction meetings 3 days prior to beginning any construction activity subject to the requirements of 21 DCMR, Chapter 5.

**Inspections During Construction.** The applicant is required to contact DOEE to schedule inspection 3 days prior to any stage of BMP construction, or other construction activity, requiring an inspection. For large, complicated projects, the applicant and DOEE may agree during the preconstruction meeting to an alternative approach such as a weekly notification schedule. Any such agreement must be made in writing and signed by all parties. DOEE will revert to the 3-day notification procedure if the agreement is not followed.

During construction, DOEE may require the presence of the professional engineer responsible for sealing the approved SWMP; the professional engineer responsible for certifying the as-built SWMP; or for a project entirely in the PROW, the officer of the contracting company responsible for certifying the Record Drawing.

**Final Inspection.** The applicant is required to contact DOEE to schedule a final inspection one week prior to the completion of a BMP construction to schedule a final inspection of the BMP.

Upon completion of the BMP, DOEE will conduct a final inspection to determine if the completed work was constructed in accordance with approved plans.

**Inspection Requirements by BMP Type.** Chapter 3, "Stormwater Best Management Practices (BMPs)" of this guidebook provides details about the construction sequences for each BMP. After holding a preconstruction meeting, regular inspections will be made at the following specified stages of construction:

- **Infiltration Systems and Bioretention Areas** shall be inspected at the following stages to ensure proper placement and allow for infiltration into the subgrade:
  - (a) Upon completion of stripping, stockpiling, or construction of temporary sediment control and drainage facilities;
  - (b) Upon completion of excavation to the subgrade;

- (c) Throughout the placement of perforated PVC/HDPE pipes (for underdrains and observation wells) including bypass pipes (where applicable), geotextile materials, gravel, or crushed stone course and backfill; and
- (d) Upon completion of final grading and establishment of permanent stabilization;
- **Flow Attenuation Devices**, such as open vegetated swales upon completion of construction;
- **Retention and Detention Structures**, at the following stages:
  - (a) Upon completion of excavation to the sub-foundation and, where required, installation of structural supports or reinforcement for structures, including but not limited to the following:
    - ◆ Core trenches for structural embankments;
    - ◆ Inlet-outlet structures and anti-seep structures;
    - ◆ Watertight connectors on pipes; and
    - ◆ Trenches for enclosed stormwater drainage facilities;
  - (b) During placement of structural fill and concrete and installation of piping and catch basins;
  - (c) During backfill of foundations and trenches;
  - (d) During embankment construction; and
  - (e) Upon completion of final grading and establishment of permanent stabilization;
- **Stormwater Filtering Systems**, at the following stages:
  - (a) Upon completion of excavation to the sub-foundation and installation of structural supports or reinforcement for the structure;
  - (b) During placement of concrete and installation of piping and catch basins;
  - (c) During backfill around the structure;
  - (d) During pouring of floors, walls, and top slab;
  - (e) During installation of manholes/trap doors, steps, orifices/weirs, bypass pipes, and sump pit (when applicable);
  - (f) During placement of the filter bed;
  - (g) Upon completion of final grading and establishment of permanent stabilization;
- **Green Roof Systems**, at the following stages:
  - (a) During placement of the drainage layer and drainage system;
  - (b) During placement of the growing media, to confirm that it meets the specifications and is applied to the correct depth (certification for vendor or source must be provided);

- (c) Upon installation of plants, to ensure they conform to the planting plan (certification from vendor or source must be provided); and
- (d) At the end of the first or second growing season, to ensure desired surface cover specified in the Care and Replacement Warranty has been achieved.

### **5.3.3 Final Construction Inspection Reports**

DOEE will conduct a final inspection to determine if the completed work is constructed in accordance with approved plans and the intent of 21 DCMR, Chapter 5. Within 21 days of the final inspection, the applicant must submit an as-built package. The as-built package includes one PDF copy of the as-built SWMP certified by a registered professional engineer licensed in the District of Columbia, an As-Built Certification By Professional Engineer form, and other supplemental documentation requested by the inspector to determine if the completed work is constructed in accordance with the approved plans. All documents should be uploaded to the Stormwater Database per DOEE requirements. For a project consisting entirely of work in the PROW, the submission of a Record Drawing certified by an officer of the project contracting company is acceptable if it details the as-built construction of the BMPs, related stormwater infrastructure, and land covers.

A registered professional engineer licensed in the District is required to certify as-built SWMPs and state that all activities including clearing, grading, site stabilization, the preservation or creation of pervious land cover, the construction of drainage conveyance systems, the construction of BMPs, and all other stormwater-related components of the project were accomplished in strict accordance with the approved SWMP and specifications. As stated in Section 5.2.4, “Resubmission of Stormwater Management Plans,” all plan changes are subject to DOEE approval. The as-built certification must be on the original SWMP.

Upon completion, these plans will be submitted to DOEE for processing. The estimated time for processing will be two weeks (10 working days), after which the plans will be returned to the engineer. DOEE will provide the applicant with written notification of the final inspection results. DOEE will maintain a permanent file of inspection reports.

### **5.3.4 Inspection for Preventive Maintenance**

DOEE requires maintenance inspections for BMPs and landcovers to ensure their ongoing performance in compliance with 21 DCMR, Chapter 5. The inspection will occur at least once every 3 years. Maintenance inspection forms are provided in Appendix M - Maintenance Inspection Checklists. DOEE will conduct these maintenance inspections, though it may, in certain circumstances, allow a property to self-inspect and provide documentation.

DOEE will maintain maintenance inspection reports for all BMPs. The reports will evaluate BMP functionality based on the detailed BMP requirements of Chapter 3 Stormwater Best Management Practices (BMPs) and inspection forms found in Appendix M - Maintenance Inspection Checklists.

If, after an inspection by DOEE, the condition of a BMP presents an immediate danger to the public safety or health because of an unsafe condition or improper maintenance, DOEE will take



such action as may be necessary to protect the public and make the BMP safe. Any costs incurred by DOEE will be assessed against the owner(s).

## **5.4 Maintenance**

### **5.4.1 Maintenance Responsibility**

A site with an approved SWMP must maintain the BMPs and land covers according to the maintenance schedule in the SWMP and this guidebook. Land covers must be maintained in type and extent as approved. Approved BMPs must be kept in good condition, including all the engineered and natural elements of each practice, as well as conveyance features (e.g., grade surfaces, walls, drains, structures, vegetation, soil erosion and sediment control measures, and other protective devices). All repairs or restorations must be in accordance with the approved SWMP.

A declaration of covenants including an exhibit stating the owner's specific maintenance responsibilities must be recorded at the Record of Deeds. A maintenance schedule for any BMP will be developed for the life of the project and shall state the maintenance to be completed, the time for completion, and who will perform the maintenance. The maintenance schedule will be printed on the SWMP and will appear as an exhibit in the declaration of covenants.

### **5.4.2 Maintenance Agreement**

Maintenance obligations are binding on current and future owners of a property subject to 21 DCMR, Chapter 5. DOEE will not issue final approval of a complete set of the SWMP for private parcels until the applicant has executed a declaration of covenants providing notice of this obligation to current and subsequent owners of the land served by the BMP(s) and land covers. Maintenance agreements by major regulated projects include providing access to the site and the BMP(s) at reasonable times for regular inspection by DOEE and for regular or special assessments of property owners, as needed, to ensure that the BMP(s) is maintained in proper working condition and the land covers are retained as approved in the SWMP. An example of the declaration of covenants for a site with BMPs and designated land covers is provided at the end of this chapter.

The applicant must record the agreement as a declaration of covenants with the District of Columbia Recorder of Deeds. The agreement must also provide that, if after written notice by DOEE to correct a violation requiring maintenance work, satisfactory corrections are not made by the owner(s) of the land served by the BMP within a reasonable period of time, not to exceed 45 to 60 days unless extended for good cause shown, DOEE may perform all necessary work to place the BMP in proper working condition. The owner(s) of property served by the BMP will be assessed the cost of the work and any penalties, and there will be a lien on any property served by the BMP, which may be placed on the tax bill and collected as ordinary taxes by the District.

## **5.5 Supporting Forms**

You must submit the following forms to support DOEE review and approval of SWMPs. These forms should be submitted to DOEE using the Stormwater Database, as directed by DOEE (see Figure 5.4 through Figure 5.13).

- DC Water/DOEE Storm Sewer Verification Form
- As-Built Certification by Professional Engineer Form
- Statement By Professional Engineer Registered In the District of Columbia Form
- Statement By Person Responsible For Maintenance Form
- Statement By Person Responsible For Achieving Off-Site Retention Form
- Anacostia Waterfront Development Zone Site Form
- Application for Exempt Land-Disturbing Activity
- Declaration of Covenants Template
- Amendment to Declarations of Covenants
- Termination and Release of Declaration of Covenants
- Environmental Intake Form

These forms are subject to change with the latest versions available at <https://doee.dc.gov/swguidebook>.

**GOVERNMENT OF THE DISTRICT OF COLUMBIA  
DEPARTMENT OF ENERGY AND ENVIRONMENT**

**Application for Discharge from New Stormwater Management BMP**

1. *Proposed Discharge from Stormwater Best Management Practice (BMP)*

A. BMP Type(s): \_\_\_\_\_

B. Project Location: \_\_\_\_\_  
 Square: \_\_\_\_\_ Lot: \_\_\_\_\_

C. Pre-Project Peak Flow:  
 15-Year \_\_\_\_\_ cfs  
 Post-development Peak Flow:  
 15-Year \_\_\_\_\_ cfs

D. Receiving Sewer System - Type, Location, Slope, and Depth:  
 Combined Sewer     Separate Storm Sewer     Open Channel  
 Receiving Sewer: Pipe Size: \_\_\_\_\_ in. Pipe Material: \_\_\_\_\_ Pipe Slope: \_\_\_\_\_ %  
 Depth of Receiving Sewer (FG to pipe invert): \_\_\_\_\_ ft.  
 Approximate Groundwater Depth (FG to groundwater): \_\_\_\_\_ ft.  
 Discharge Location or Name of Surface Waterway (if open channel):  
 \_\_\_\_\_

E. Size of Proposed Storm Lateral(s): \_\_\_\_\_ in.

F. Invert Elevation of Proposed Storm Lateral Connection(s): \_\_\_\_\_ ft.

Requested By: \_\_\_\_\_  Agent  Owner  
 Address: \_\_\_\_\_  
 Tel: (    ) \_\_\_\_\_ Fax: (    ) \_\_\_\_\_ Date Requested: \_\_\_\_\_

---

**(OFFICIAL USE ONLY)**

2. *Hydraulic Sewer System Verification By DC Water:*

A.  Combined Sewer     Separate Storm Sewer     Open Channel  
 Clean Rivers     Bloomingdale Area     Other \_\_\_\_\_

B. Receiving Sewer: Pipe Size: \_\_\_\_\_ in. Pipe Material: \_\_\_\_\_ Pipe Slope: \_\_\_\_\_ %

C. Depth of Receiving Sewer (FG to pipe invert): \_\_\_\_\_ ft.

D. Estimated Manning's Capacity (full pipe flow) of Receiving Sewer \_\_\_\_\_ cfs

E. Is the Estimated Available Hydraulic Capacity Exceeded?  Yes  No

DC Water Verification By: Name \_\_\_\_\_, Title \_\_\_\_\_  
 Plans Approved?  Yes  No Maximo #: \_\_\_\_\_ Tel: (    ) \_\_\_\_\_ Date Verified: \_\_\_\_\_

DOEE RRD Verification By: (Name) \_\_\_\_\_, Title \_\_\_\_\_  
 Tel: (    ) \_\_\_\_\_ Fax: (    ) \_\_\_\_\_ Date Verified: \_\_\_\_\_  
 DOEE Swdb PLAN #: \_\_\_\_\_ DCRA Permit #: \_\_\_\_\_

Notes: \_\_\_\_\_

Figure 5.4 DC Water/DOEE Storm Sewer Verification form.

**AS-BUILT CERTIFICATION BY PROFESSIONAL ENGINEER**

Within 21 days after completion of construction of all stormwater best management practices (BMPs), stormwater infrastructure, and land covers (collectively the "Facility"), please send this page to the Regulatory Review Division of the Department of Energy and Environment.

1. **Facility information:**

Source Name: \_\_\_\_\_

Source Location: Street: \_\_\_\_\_

City: \_\_\_\_\_

DCRA Permit No.: \_\_\_\_\_

Date Issued: \_\_\_\_\_

2. **As Built Certification**

I hereby certify that all stormwater best management practices (BMPs), stormwater infrastructure, and land covers have been built substantially in accordance with the approved plans and specifications and that any deviations noted below will not prevent the system from functioning in compliance with the requirements Chapter 5 of Title 21 of the District of Columbia Municipal Regulations when properly maintained and operated. These determinations have been based upon on-site observation of construction, scheduled and conducted by me or by a project representative under my direct supervision. I have enclosed one set of as-built engineering drawings.

\_\_\_\_\_

Signature of Engineer

Affix Seal:

Name (Please Type) D.C. Reg. No.

\_\_\_\_\_

Company Name

\_\_\_\_\_

Company Address

\_\_\_\_\_

Date: \_\_\_\_\_ Phone No.: \_\_\_\_\_

Substantial deviations from the approved plans and specifications (attach additional sheets if required).

\_\_\_\_\_

\_\_\_\_\_

\_\_\_\_\_

\_\_\_\_\_

**Figure 5.5 As-Built Certification By Professional Engineer form.**

**STATEMENT BY PROFESSIONAL ENGINEER REGISTERED IN  
THE DISTRICT OF COLUMBIA**

This is to certify that the engineering features of all stormwater best management practices (BMPs), stormwater infrastructure, and land covers (collectively the "Facility") have been designed/examined by me and found to be in conformity with modern engineering principles applicable to the treatment and disposal of stormwater pollutants. I further certify that the Facility has been designed in accordance with the specification required under Chapter 5 of Title 21 of the District of Columbia Municipal Regulations. It is also stated that the undersigned has furnished the applicant with a set of instructions for the maintenance and operation of the site's Facility.

\_\_\_\_\_  
Name and Title (please type)

\_\_\_\_\_  
Address

\_\_\_\_\_  
Date \_\_\_\_\_ Phone No: \_\_\_\_\_

Affix Seal:



**Figure 5.6 Statement By Professional Engineer Registered In the District of Columbia form.**

**STATEMENT BY PERSON RESPONSIBLE FOR MAINTENANCE**

The undersigned agrees to maintain compliance with the performance requirements and other provisions of Chapter 5 of Title 21 of the District of Columbia Municipal Regulations (DCMR). This includes maintaining and operating stormwater best management practices (BMPs), stormwater infrastructure, and land covers as specified in the Stormwater Management Plan approved by the District Department of Energy and Environment (DOEE).

Responsibility for maintenance and operation may be transferred to another entity upon written notice to the Regulatory Review Division of DOEE from the undersigned and the entity assuming responsibility. This notice must certify that the transfer of responsibility for maintenance and operation is in compliance with 21 DCMR Chapter 5.

\_\_\_\_\_  
Signature of the person responsible for maintenance (it may be the applicant)

\_\_\_\_\_  
Name and Title (please type)

\_\_\_\_\_  
Address

\_\_\_\_\_  
Date \_\_\_\_\_ Phone No: \_\_\_\_\_

**Figure 5.7 Statement By Person Responsible For Maintenance form**

**STATEMENT BY PERSON RESPONSIBLE FOR ACHIEVING  
OFF-SITE RETENTION**

This site has an off-site retention volume (Offv) obligation. The Offv for this site equals \_\_\_\_\_ (gallons).

The undersigned agrees to satisfy the obligation to achieve Offv, in such a manner as to comply with the provisions of Chapter 5 of Title 21 of the District of Columbia Municipal Regulations (DCMR).

Responsibility for achieving Offv may be transferred to another entity upon written notice to the Regulatory Review Division of the Department of Energy and Environment from the undersigned and the entity assuming responsibility. This notice must certify that the transfer of responsibility for Offv is in compliance with 21 DCMR Chapter 5.

\_\_\_\_\_  
Signature of the person responsible for achieving Offv

\_\_\_\_\_  
Name and Title (please type)

\_\_\_\_\_  
Address

\_\_\_\_\_  
Date \_\_\_\_\_ Phone No: \_\_\_\_\_

**Figure 5.8 Statement By Person Responsible For Achieving Off-Site Retention form**

**GOVERNMENT OF THE DISTRICT OF COLUMBIA**  
**DEPARTMENT OF CONSUMER REGULATORY AFFAIRS**

★ ★ ★  
■■■■

**REGULATED ANACOSTIA WATERFRONT  
DEVELOPMENT ZONE (AWDZ) SITE**

Address: \_\_\_\_\_

Square: \_\_\_\_\_ Lot: \_\_\_\_\_

1. Is the project located within the Anacostia Waterfront Development Zone (AWDZ)? See Stormwater Management Guidebook Figure 2.1 *Map of Anacostia Waterfront Development Zone* for reference.  
 Yes (continue to next question)  
 No (This is not a regulated AWDZ site, you can skip the rest of this form)
2. Is the site District owned or District-instrumentality owned? Check the District Office of Tax and Revenue Real Property Assessment Database for site owner  
[https://www.taxpayerservicecenter.com/RP\\_Search.jsp?search\\_type=Assessment](https://www.taxpayerservicecenter.com/RP_Search.jsp?search_type=Assessment).  
 Yes (this site is a regulated AWDZ site and shall employ Best Management Practices (BMPs) and land cover necessary to meet the requirements of 21 DCMR §524 Stormwater Management Performance Requirements for Major Regulated Projects in the Anacostia Waterfront Development Zone)  
 No (continue to next question)
3. Is fifteen percent (15%) or more of the project's total cost District-financed or District instrumentality-financed?  
 Yes (this site is a regulated AWDZ site and shall employ Best Management Practices (BMPs) and land cover necessary to meet the requirements of 21 DCMR §524 Stormwater Management Performance Requirements for Major Regulated Projects in the Anacostia Waterfront Development Zone)  
 No (continue to next question)
4. Does the project include a gift, lease, or sale from District-owned or District instrumentality-owned property to a private entity?  
 Yes (this site is a regulated AWDZ site and shall employ Best Management Practices (BMPs) and land cover necessary to meet the requirements of 21 DCMR §524 Stormwater Management Performance Requirements for Major Regulated Projects in the Anacostia Waterfront Development Zone)  
 No (This is not an AWDZ site, you can skip the rest of this form)

I certify that all statements on this form are true and complete to the best of my knowledge and belief. I agree to comply with all applicable District of Columbia laws and regulations. The making of false statements on this form is punishable by criminal penalties (D.C. Official Code § 22-2405).

\_\_\_\_\_  
Signature of Owner or Authorized Agent

\_\_\_\_\_  
Date

\_\_\_\_\_  
DCRA, 1100 4<sup>th</sup> Street, SW, Suite E650 Washington, DC 20024 phone 202-442-4400 fax 202-442-9445

**Figure 5.9 Anacostia Waterfront Development Zone Site form**



**GOVERNMENT OF THE DISTRICT OF COLUMBIA**  
Department of Energy and Environment



**Application for Exempt Land-Disturbing Activity**

**Acronyms**

DOEE Department of Energy and Environment    SWMP Stormwater Management Plan

**Application date:** \_\_\_\_\_

**Address of regulated site:**

\_\_\_\_\_

Lot: \_\_\_\_\_ Square: \_\_\_\_\_ Ward: \_\_\_\_\_

**Is the site in a publicly accessible area (Yes or No)?** \_\_\_\_

**Plan Number:** \_\_\_\_\_

**Name of site owner:** \_\_\_\_\_

Address: \_\_\_\_\_

E-Mail: \_\_\_\_\_ Phone: \_\_\_\_\_

**Name of owner's agent (if applicable):** \_\_\_\_\_

Address: \_\_\_\_\_

E-Mail: \_\_\_\_\_ Phone: \_\_\_\_\_

**Indicate the type of land-disturbing activity:**

- Trails for pedestrians or non-motorized vehicles
- Athletic playing fields, permeable athletic tracks, or permeable playground surfaces
- Pavilion, shed, dugout, or similar structure

**Figure 5.10 Application for exempt land-disturbing activity.**

**Provide description of project and primary use. Include description of public accessibility of the site:**

\_\_\_\_\_

\_\_\_\_\_

\_\_\_\_\_

\_\_\_\_\_

**Indicate the pre-project land cover area:**

Land Cover Type	Natural Cover	Compacted Cover	Impervious Cover	BMP
Area (square feet)				

**Provide related SWMP number(s) for related development at this site (if applicable):**

\_\_\_\_\_

**Applicant's Signature**

A. Owner of regulated property: I hereby certify that I am the owner of the regulated property and that this application is correct to the best of my knowledge.

Signature of Owner: \_\_\_\_\_ Date: \_\_\_\_\_

B. Agent: I hereby certify that I have the authority of the regulated property owner to make this application. I declare that this application is correct to the best of my knowledge.

Signature of Agent: \_\_\_\_\_ Date: \_\_\_\_\_

<b>FOR DEPARTMENT USE ONLY</b>		
Approved:	Approved in part:	Disapproved:
Signature:		Date:
Notes:		

Page 2 of 3

Figure 5.10 (continued)

**Instructions for Application for Exempt Land-Disturbing Activity**

Purpose of form: This form provides DOEE with the necessary information to determine if a land-disturbing activity is exempt from stormwater management requirements.

**Instructions**

**Application date:** Enter the date that the applicant completes the application.

**Address of regulated site:** Enter the street address for the regulated site that is applying for exemption. Lot, square, and ward information is available from the building permit.

**Is the site in a publicly accessible area (Yes or No)?** Select “yes” or “no”.

**Plan Number:** Provide the plan number for this regulated project.

**Name of site owner:** Enter the name of the site owner. Also provide the site owner’s contact information.

**Name of owner’s agent:** If applicable, enter the name of a representative whom the owner has designated.

**Indicate the type of land-disturbing activity:** Check the applicable box that describes the land-disturbing activity. Complete a separate form if there is more than 1 type of land-disturbing activity at the site.

**Provide description of project and primary use. Include description of public accessibility of the site:** Provide a brief description of the project and its intended primary use. Include a description of how the site is accessible to the public.

**Indicate the pre-project land cover area:** Enter the area in square feet of the pre-project land cover type. This is area of the proposed land-disturbance.


**Provide related SWMP number(s) for related development at this site (if applicable):** If the regulated site is part of a common plan of development or if there are other recent projects on the property, provide the SWMP number of the related projects. This is to provide DOEE with information on the entire scope of work at the site.

Page 3 of 3

Figure 5.10 (continued)

**GOVERNMENT OF THE DISTRICT OF COLUMBIA**  
**Office of the Attorney General**

Commercial Division



**Procedure and Protocol for obtaining legal sufficiency review of a Stormwater Management Declaration of Covenants from the Office of the Attorney General (OAG)**

DC Official Code Section 8-103.01 provides for the promulgation of rules to implement the provision. Section 529 of Title 21 of the District of Columbia Municipal Regulations (DCMR) requires that, under certain circumstances, owners of real property execute a stormwater declaration of covenants containing a stormwater management plan (SWMP) and an easement in favor of the Department of Energy and Environment (DOEE) insuring access. Section 529.3 of the DCMR provides that the declaration of covenants and easement shall "be determined legally sufficient by the Attorney General or the Department's [DOEE's] Designee."  
DOEE and OAG have agreed that OAG shall determine legal sufficiency.

**Department of Energy and Environment must:**

1. Provide name and e-mail address of technical reviewer so that OAG may discuss technical issues. If necessary, OAG will provide a PDF of the signed Declaration of Covenants to the DOEE reviewer.
2. Provide attached template of the Declaration of Covenants to the owner/developer.

**Review Engineer:**  
**E-mail address:**

**Owner/developer must:**

1. Draft the Declaration of Covenants.
2. Subordinate all prior liens to the Declaration.
3. Produce evidence of title and all liens on the property (i.e. copy of deed and full title search).
4. Provide a site plan (Exhibit B) as approved by DOEE, showing all required stormwater Best Management Practices (BMPs) and land covers and documenting any Off-Site Retention Volume (Offv), as well as the Required Plan Compliance Sheet generated from the Stormwater Database.
5. Provide a maintenance plan of all stormwater BMPs, stormwater infrastructure, and land covers for District approval pursuant to 21 DCMR § 519 (Exhibit C).
6. Submit a pdf of the covenant based on the attached form and modified and completed for execution (with Exhibits A, B, and C) and the information set forth in 3 above to the Contact Person at OAG [the submission need not be executed]. Once the OAG Contact Person has approved the form of your covenant and Exhibit A, send by mail or hand delivery the complete, original covenant signed by the Declarant.
7. After receiving notification of OAG approval for legal sufficiency, return the OAG approved and signed original covenant to DOEE with all exhibits for technical sufficiency review and approval.
8. Provide copy of recorded Declaration of Covenants to DOEE.

**Contact Person at OAG:**  
Lawrence Wolk  
Assistant Attorney General  
Commercial Division  
D.C. Office of the Attorney General  
441 4<sup>th</sup> Street, NW, Suite 1010 South  
Washington, DC 20001  
Tel: (202) 724-5094  
Fax: (202) 741-0420  
[lawrence.wolk@dc.gov](mailto:lawrence.wolk@dc.gov)

Updated May 1, 2018

Figure 5.11 Declaration of Covenants Template.

**GOVERNMENT OF THE DISTRICT OF COLUMBIA**

**Department of Energy and Environment  
NATURAL RESOURCES ADMINISTRATION  
REGULATORY REVIEW DIVISION**

**DECLARATION OF COVENANTS  
For a Stormwater Management Facility**

THIS DECLARATION OF COVENANTS (the “**Declaration**”) is made as of this day of \_\_\_\_\_, 20\_\_\_\_, by and between **NAME OF PROPERTY OWNER, a LIST TYPE OF CORPORATE ENTITY (if applicable)**, and its successors and assigns (“**Owner**”), for the benefit of the DISTRICT OF COLUMBIA, a municipal corporation (the “**District**”).

**RECITALS**

A. The Owner is the owner in fee simple of certain real property and improvements (collectively, the “**Property**”) located in the District of Columbia and more particularly described in **Exhibit A** attached hereto and made a part hereof. No other person or entity has an ownership interest in the Property.

B. In order to manage stormwater flow conditions resulting from certain improvements Owner will make to the Property, the regulations of the District, found at Title 21, Chapter 5, of the District of Columbia Municipal Regulations (“DCMR”) require that Owner develop and submit for approval a Stormwater Management Plan (“SWMP”) for the installation and maintenance of all stormwater best management practices (“BMPs”), stormwater infrastructure, and land covers on the Property (collectively, the “**Facility**”), and including any obligation to achieve Off-Site Retention Volume (Offv).

C. Section 529 of Title 21 of the DCMR requires that Owner execute and record, with the District of Columbia Recorder of Deeds, a declaration of covenants running with the land that set forth Owner’s responsibilities under the SWMP.

NOW, THEREFORE, for and in consideration of the issuance of building permits and approval of Owner’s plans by the District, and other good and valuable consideration the sufficiency of which is hereby acknowledged, for the benefit of and limitation upon Owner and all future owners of the Property, and for the benefit of the District, Owner for itself, its successors and assigns, does hereby acknowledge, represent, covenant, agree, and warrant to the District as follows:

1. The foregoing Recitals and attached Exhibits are all hereby incorporated in and made a part of this Declaration to the same extent as if herein set forth in full, provided however, that said Recitals shall not be deemed to modify the express provisions hereinafter set forth.

2. The Facility and any responsibility to achieve Off-Site Retention Volume (Offv), as stated in gallons, is shown on the plans approved by the District attached hereto as **Exhibit B**, the Site Plan, as the same may be amended pursuant to the District’s approval.

**Figure 5.11 (continued)**

3. Owner, at its sole expense, shall construct and perpetually operate and maintain the Facility in such manner as to comply with the provisions of Title 21, Chapter 5 of the DCMR and in strict accordance with the SWMP, including the Maintenance Plan, attached hereto as **Exhibit C**, as the same may be amended pursuant to the District's approval.

4. Owner shall, at its sole expense, make such changes or modifications to the Facility as the District, in its discretion, may determine necessary to ensure that the Facility is maintained in good condition and continues to operate as designed and approved.

5. The District and its agents, employees, and contractors shall have the right to enter the Property for the purpose of inspecting the Facility in accordance with established inspection procedures and Section 16 of the Water Pollution Control Act of 1984 (D.C. Law 5-188; 32 DCR 919; D.C. Official Code § 8-103.01, *et seq.* (2013 Repl.), as amended (the "Act"), at reasonable times and in a reasonable manner, in order to ensure that the Facility is being properly maintained and is continuing to perform in the manner approved by the District.

6. Should Owner fail to perform its responsibilities as required herein, or fail to operate and restore the Facility in accordance with approved design standards, as the same may be amended from time to time, the District shall be entitled to pursue any and all enforcement actions available to it pursuant to the Act, and Title 21, Chapter 22 of the DCMR, as the same may be amended from time to time. Without limiting the generality of the foregoing, in the event that a discharge or threat of discharge from the Facility poses an imminent and substantial danger to the environment or the public health or welfare, the District may take immediate action against Owner pursuant to D.C. Official Code § 8-103.08(b).

7. If Owner's failure or refusal to maintain the Facility in accordance with the covenants and warranties contained in this Declaration ultimately results in corrective action by the District, Owner shall bear all costs incurred by the District for such corrective measures, such costs may be assessed against the Property, and Owner may be fined in accordance with the Act and Title 21, Chapter 5 of the DCMR.

8. The provisions of this Declaration shall be deemed warranties by Owner and covenants running with the land and shall bind and inure to the benefit of Owner and the District, their respective heirs, successors and/or assigns. When Owner ceases to own an interest in the Property, the rights, warranties, and obligations under this Declaration shall become the rights, warranties, and obligations of the successor-in-ownership and interest to the Property.

9. Owner shall, at its cost and expense, properly record this Declaration with the Recorder of Deeds and provide the District's Department of the Environment with a copy of this Declaration, certified by the Recorder of Deeds as a true copy of the recorded instrument.

10. Owner shall indemnify, save harmless, and defend the District, and all its officers, agents, and employees from and against all claims or liabilities that may arise out of or in connection with, either directly or indirectly, any of Owner's actions or omissions with regard to the construction, operation, maintenance and/or restoration of the Facility.

11. Owner warrants, and shall ensure, that all prior liens recorded against the Property are subordinate to this Declaration. Failure to subordinate liens shall, at the District's sole

Figure 5.11 (continued)

election, give rise to termination of any building permits and/or invalidation of any certificate of occupancy relating to the Property.

12. Owner shall, at its sole expense, comply with all provisions of this Declaration regardless of any conflicting requirements in any other covenant, easement, or other legal document recorded or unrecorded against the Property. Neither the entering into of this Declaration nor performance hereunder will constitute or result in a violation or breach by Owner of any other agreement or order that is binding on Owner.

13. To the extent Owner is an entity, Owner warrants that it: (i) is duly organized, validly existing and in good standing under the laws of its state of organization; (ii) is qualified to do business in, and is in good standing under, the laws of the District of Columbia; (iii) is authorized to perform under this Declaration; and (iv) has all necessary power to execute and deliver this Declaration.

14. The form of this Declaration has been approved by the District of Columbia Office of the Attorney General (“OAG”) for legal sufficiency pursuant to Title 21, Section 529.3 of the DCMR. This Declaration, and the provisions contained herein, may not be modified, amended, or terminated without the prior written consent of the District and legal sufficiency approval by OAG, such agreement to be evidenced by a document duly executed and delivered in recordable form and recorded with the Recorder of Deeds at no expense to the District.

15. The District has the right to specifically enforce this Declaration.

16. This Declaration shall be governed by, construed under, and enforced in accordance with, the laws of the District of Columbia.

17. This Declaration has been duly executed and delivered by Owner, and constitutes the legal, valid, and binding obligations of Owner, enforceable against Owner and its successors and assigns, in accordance with its terms.

18. If any of the covenants, warranties, conditions or terms of this Declaration shall be found void or unenforceable for whatever reason by any court of law or of equity, then every other covenant, condition or term herein set forth shall remain valid and binding.

**[SIGNATURES FOLLOW]**

**Figure 5.11 (continued)**

IN WITNESS WHEREOF, Owner has, as of the day and year first above written, caused this Declaration of Covenants to be signed by **NAME AND TITLE OF PERSON SIGNING ON BEHALF OF OWNER**.

By: \_\_\_\_\_  
          **NAME, TITLE**  
\_\_\_\_\_

**ACKNOWLEDGMENT**

\_\_\_\_\_  
LIST STATE \_\_\_\_\_ )  
  ) ss:  
LIST COUNTY \_\_\_\_\_ )

I, **NAME OF NOTARY**, a Notary Public in and for the jurisdiction aforesaid, do hereby certify that **NAME OF PERSON SIGNING ON BEHALF OF OWNER**, who is personally well known (or satisfactorily proven) to me, and being authorized to do so, executed the foregoing Declaration of Covenants and has acknowledged the same to be the act and deed of **NAME OF OWNER**, and that s/he delivered the same as such.

GIVEN under my hand and seal this \_\_\_\_ day of \_\_\_\_\_, 20\_\_.

\_\_\_\_\_  
Notary Public

My commission expires:  
**[NOTARIAL SEAL]**

5

Figure 5.11 (continued)



**APPROVED AS TO TECHNICAL SUFFICIENCY:**

District of Columbia Department of Energy and Environment  
Natural Resources Administration  
Regulatory Review Division

By: \_\_\_\_\_  
Name: \_\_\_\_\_  
Title: \_\_\_\_\_  
Date: \_\_\_\_\_

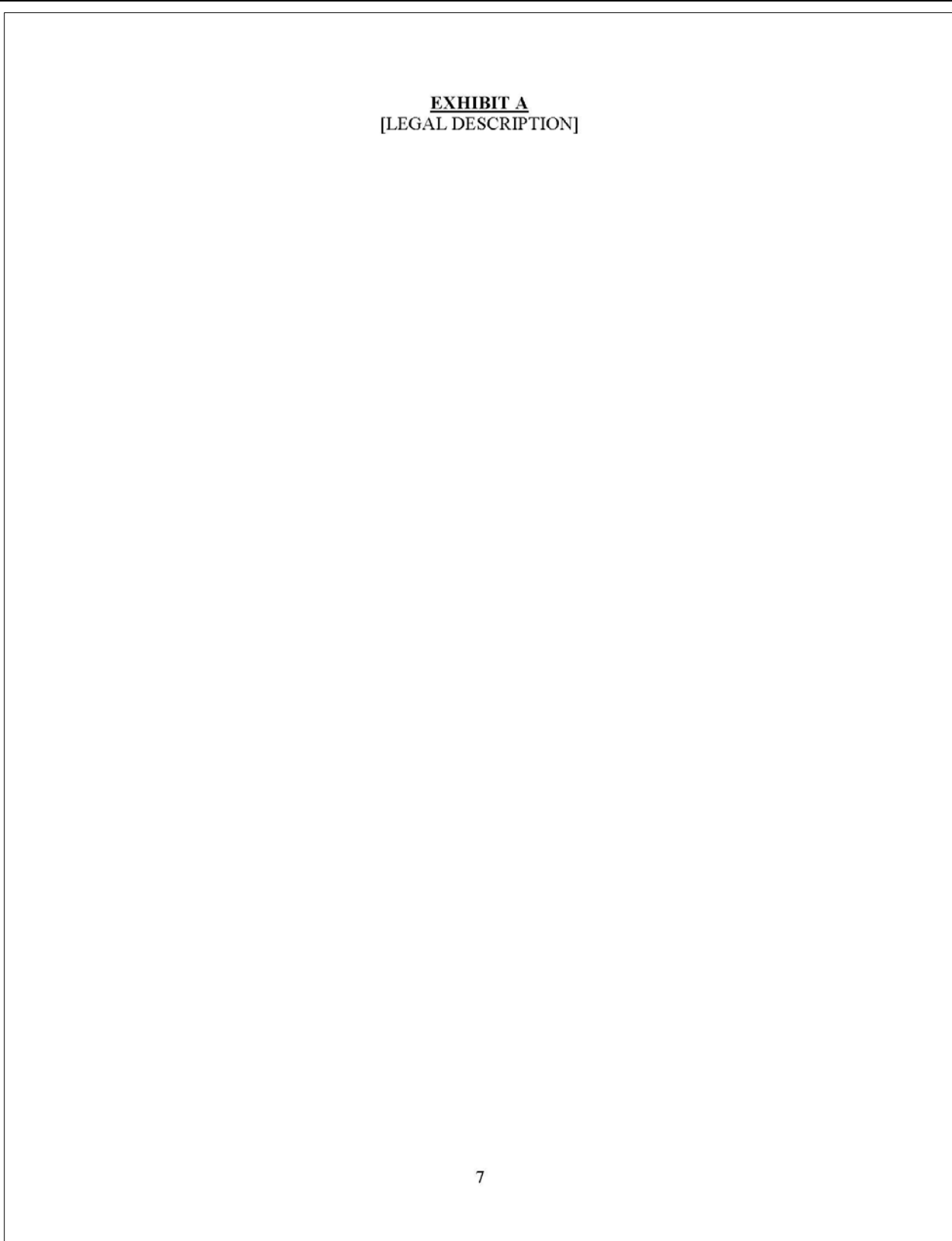
**APPROVED AS TO LEGAL SUFFICIENCY:**

District of Columbia Office of the Attorney General  
Commercial Division

By: \_\_\_\_\_  
Assistant Attorney General  
Date: \_\_\_\_\_

**Property Address [include Square and Lot(s)]:**

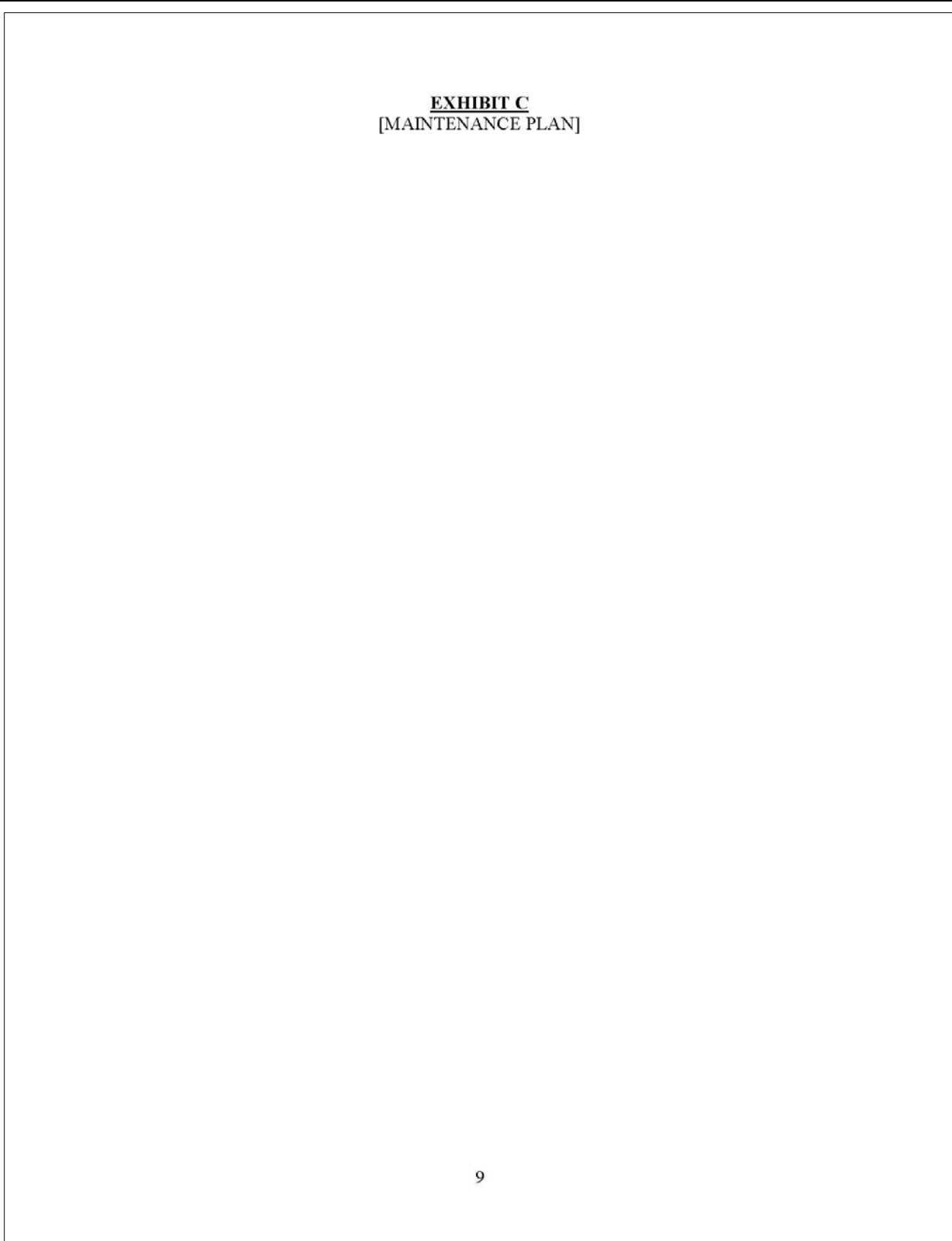
**Figure 5.11 (continued)**



**Figure 5.11 (continued)**

**EXHIBIT B**  
**[SITE PLAN]**

**Figure 5.11 (continued)**



**Figure 5.11 (continued)**

**THE GOVERNMENT OF THE DISTRICT OF COLUMBIA**

**Department of Energy and Environment  
NATURAL RESOURCES ADMINISTRATION  
REGULATORY REVIEW DIVISION**

**AMENDMENT TO DECLARATION OF COVENANTS  
For a Stormwater Management Facility**

THIS AMENDMENT TO DECLARATION OF COVENANTS (the “**Amendment**”) is made this [redacted] day of [redacted], 20[redacted], by **OWNER** and its successors and assigns (“**Owner**”) to amend the Declaration of Covenants dated [redacted], previously approved and recorded with the Recorder of Deeds as Instrument Number [redacted] (the “**Declaration**”) for the benefit of the District of Columbia, a municipal corporation (the “**District**”).

**RECITALS**

A. The Owner is the owner in fee simple of certain real property and improvements (collectively, the “**Property**”) located in the District of Columbia and more particularly described in **Exhibit A** attached hereto and made a part hereof. No other person or entity has an ownership interest in the Property.

B. In order to manage stormwater flow conditions resulting from certain improvements Owner will make to the Property, the regulations of the District, found at Title 21, Chapter 5, of the District of Columbia Municipal Regulations (“DCMR”) require that Owner develop and submit for approval a Stormwater Management Plan (“SWMP”) for the installation and maintenance of all stormwater best management practices (“BMPs”), stormwater infrastructure, and land covers on the Property (collectively, the “**Facility**”), and including any obligation to achieve Off-Site Retention Volume (Offv).

C. Section 529 of Title 21 of the DCMR requires that Owner execute and record, with the District of Columbia Recorder of Deeds, a declaration of covenants running with the land that set forth Owner’s responsibilities under the SWMP.

NOW, THEREFORE, for and in consideration of the issuance of building permits and approval of Owner’s plans by the District, and other good and valuable consideration the sufficiency of which is hereby acknowledged, for the benefit of and limitation upon Owner and all future owners of the Property, and for the benefit of the District, Owner for itself, its successors and assigns, does hereby acknowledge, represent, covenant, agree, and warrant to the District as follows:

1. The Facility defined in Recital B and referenced throughout the Declaration is now identified as [**Stormwater BMPs and land covers**].
2. Exhibits A, B, and C of the Declaration are deleted and replaced with the attached **Exhibit A, Exhibit B, and Exhibit C**.

**Figure 5.12 Amendment to Seclaration of Covenants.**

3. The Facility and any responsibility to achieve Off-Site Retention Volume (Offv), as stated in gallons, is shown on the plans approved by the District attached hereto as **Exhibit B**, the Site Plan, as the same may be amended pursuant to the District's approval.
4. All other provisions of the Declaration shall remain in full force and effect.

**Figure 5.12 (continued)**

**[SIGNATURES FOLLOW]**

IN WITNESS WHEREOF, Owner has, as of the day and year first above written, caused this Amendment to be signed by **NAME OF PERSON SIGNING**.

**NAME OF OWNER**

By: \_\_\_\_\_  
**NAME OF PERSON SIGNING**  
**TITLE**

**ACKNOWLEDGMENT**

\_\_\_\_\_  
**LIST STATE** \_\_\_\_\_ )  
\_\_\_\_\_  
\_\_\_\_\_  
**LIST COUNTY** \_\_\_\_\_ ) ss:

I, **NAME OF NOTARY**, a Notary Public in and for the jurisdiction aforesaid, do hereby certify that **NAME OF PERSON SIGNING ON BEHALF OF OWNER**, who is personally well known (or satisfactorily proven) to me, and being authorized to do so, executed the foregoing Declaration of Covenants and has acknowledged the same to be the act and deed of **NAME OF OWNER**, and that s/he delivered the same as such.

GIVEN under my hand and seal this \_\_\_\_ day of \_\_\_\_\_, 20\_\_.

\_\_\_\_\_  
Notary Public

My commission expires:

**[NOTARIAL SEAL]**

**Figure 5.12 (continued)**

**APPROVED AS TO TECHNICAL SUFFICIENCY:**

Department of Energy and Environment  
Natural Resources Administration  
Regulatory Review Division

By: \_\_\_\_\_  
Name: \_\_\_\_\_  
Title: \_\_\_\_\_  
Date: \_\_\_\_\_

**APPROVED AS TO LEGAL SUFFICIENCY:**

District of Columbia Office of the Attorney General  
Commercial Division

By: \_\_\_\_\_  
Assistant Attorney General  
Date: \_\_\_\_\_

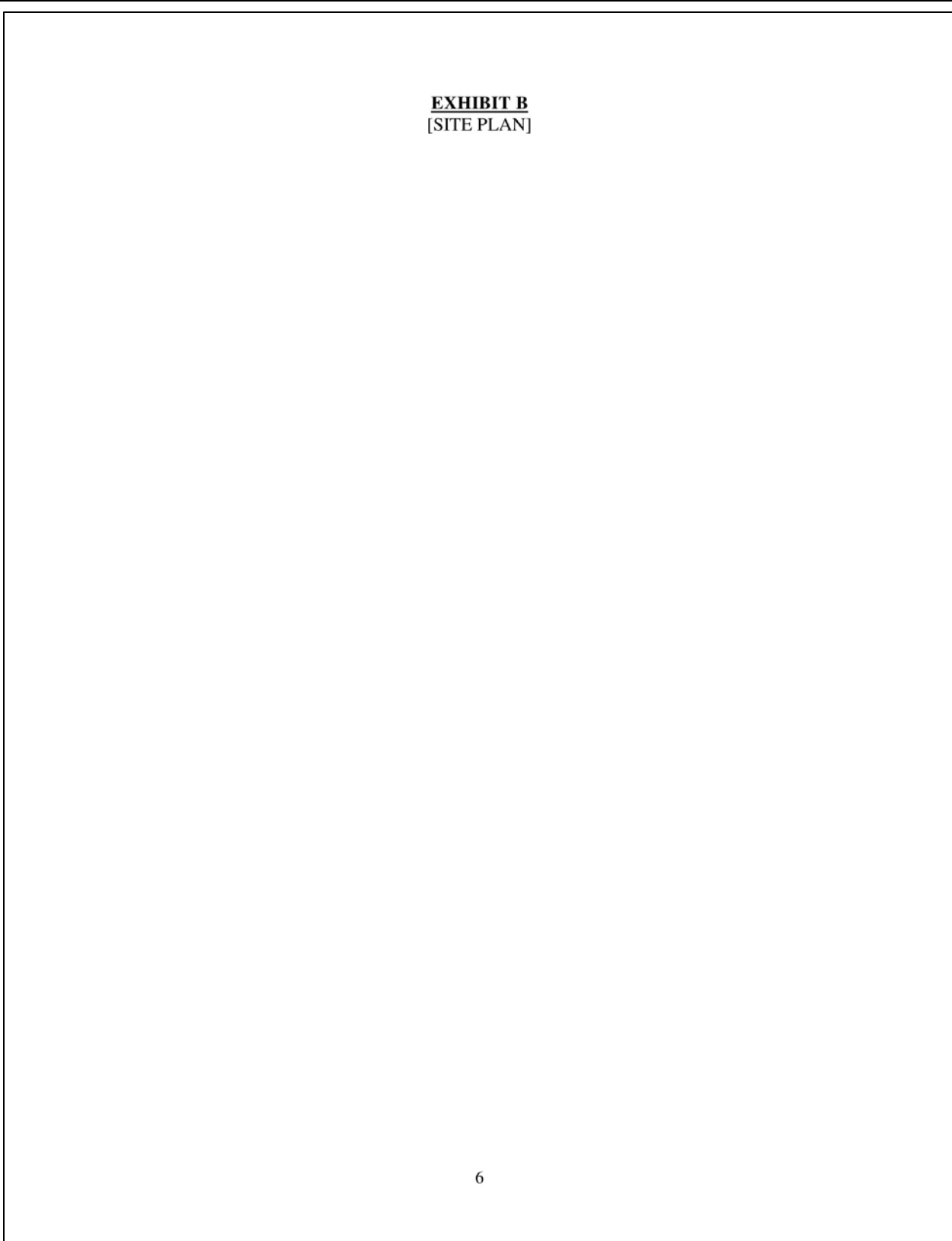
**Property Address:**

**Figure 5.12 (continued)**



**EXHIBIT A**  
[LEGAL DESCRIPTION]

**Figure 5.12 (continued)**



**Figure 5.12 (continued)**

**EXHIBIT C**  
**[MAINTENANCE SCHEDULE]**

7

**Figure 5.12 (continued)**

After recording, please return to:

**THE GOVERNMENT OF THE DISTRICT OF COLUMBIA  
DEPARTMENT OF ENERGY AND ENVIRONMENT  
REGULATORY REVIEW DIVISION**

**TERMINATION AND RELEASE OF DECLARATION OF  
COVENANTS  
For a Storm Water Management Facility**

THIS TERMINATION AND RELEASE OF DECLARATION OF COVENANTS (“Termination”) is entered into and made effective for all purposes as of this \_\_\_\_ day of \_\_\_\_\_, 20\_\_, between \_\_\_\_\_ (the “Declarant”) and the District of Columbia, acting by and through the Department of Energy and Environment (the “Beneficiary”).

WHEREAS, a Declaration of Covenants was made by Declarant for the benefit of Beneficiary on \_\_\_\_\_, \_\_\_\_\_, and recorded in the land records of the District of Columbia as Instrument No. \_\_\_\_\_ (the “Declaration”) against the affected property of the Declarant, which property is more specifically described in **Exhibit A** attached hereto (the “Property”); and

WHEREAS, the Declarant represented to Beneficiary that Declarant did not construct, nor cause to be constructed, the storm water management facility on the Property as provided in the Declaration and that the development plans for the Property submitted to the District of Columbia, including the Site Plan attached as Exhibit B to the Declaration, as of the date that the Declaration was executed (collectively, the “Site Plans”) have been abandoned and are without permit under the laws of the District of Columbia; and

**Figure 5.13 Termination and Release of Declaration of Covenants**

WHEREAS, the Declarant has cancelled any permit that may have been obtained for the Site Plans, and said Declarant has provided evidence of the same attached hereto as **Exhibit B**; and

WHEREAS, Declarant has requested a termination of and release from said Declaration, and based on the representations and agreements of Declarant, Beneficiary finds good cause for doing so.

NOW, THEREFORE, in consideration of the foregoing premises, of the mutual covenants and agreements set forth in this Termination, the sufficiency of which hereby are acknowledged, the Declarant and the Beneficiary agree as follows:

1. Termination and Release. Declarant, with the consent of the Beneficiary, hereby terminates the Declaration, and Beneficiary hereby releases Declarant from all covenants and obligations arising thereunder.
2. Declarant's Representations. Declarant hereby represents to the Beneficiary as follows: (i) at no time during Declarant's ownership of the Property has a storm water management facility been constructed on the Property, in whole or in part; (ii) neither Declarant nor its successors or assigns, to the best of Declarant's knowledge, have any intention of constructing a storm water management facility on the Property, (iii) any permits issued by the District of Columbia on the basis of the Site Plans have been cancelled and rendered void on or before the date first written above, and (iv) the Declarant has not transferred or provided copies of the

**Figure 5.13 (continued)**

Site Plans to any prospective successor to the Property and is not bound to do so under any ancillary agreement affecting the Property.

3. Indemnification. Declarant shall indemnify, hold harmless and defend the Beneficiary from any claims or liability that may arise on or after the date of this Termination, directly or indirectly as a result of a breach of the representations of the Declarant set forth in Paragraph 2 above.
4. Recordation. The Declarant shall, at its sole cost and expense, record this Declaration in the land records of the District of Columbia by filing a fully-executed, notarized original with the Recorder of Deeds within 10 days after the date first written above. Within 10 days after recordation, Declarant shall furnish a copy of the recorded Termination, as certified by the Recorder of Deeds, to the undersigned representative of the Beneficiary.
5. Entire Agreement. This Termination constitutes the entire agreement between the parties hereto with respect to the matters contemplated herein. No oral modification of this Termination shall be binding upon the parties hereto.
6. This Termination shall be governed by, construed and enforced in accordance with the laws of the District of Columbia.

**Figure 5.13 (continued)**

**IN WITNESS WHEREOF**, Declarant and Beneficiary have executed, acknowledged and delivered this Termination as of the date first above written. In furtherance of the foregoing, Beneficiary has caused this Termination to be executed by \_\_\_\_\_ (Name), \_\_\_\_\_(Title) , and has appointed \_\_\_\_\_(Name), \_\_\_\_\_(Title) its attorney in fact to execute, acknowledge and deliver this Termination as the act and deed of Beneficiary.

**DECLARANT:**

\_\_\_\_\_  
(Signature)

\_\_\_\_\_  
(Signature)

\_\_\_\_\_  
(Printed Name and Title)

\_\_\_\_\_  
(Printed Name and Title)

DISTRICT OF COLUMBIA        SS: |  
   |

I, \_\_\_\_\_, a Notary Public in and for the District of Columbia, DO HEREBY CERTIFY that \_\_\_\_\_, with annexed Termination bearing date as of the \_\_\_\_ day of \_\_\_\_\_ 2017, personally appeared before me in said District on the date given below, being personally well known to me as, or satisfactorily proven to be, the person who executed said Termination and acknowledged the same to be his/her free act and deed.

Given under my hand and official seal this \_\_day of \_\_\_\_\_,  
20\_\_.

\_\_\_\_\_  
Notary Public, D.C. [SEAL]

My commission expires: \_\_\_\_\_

**Figure 5.13 (continued)**







**Figure 5.13 (continued)**

**Exhibit B**  
[Evidence of Cancellation of Permit]

7

**Figure 5.13 (continued)**

# Chapter 6                      Use of Off-Site Retention by Regulated Sites

## 6.1 Off-Site Retention Overview

Regulated sites may retain a portion of the Stormwater Retention Volume (SWRV) through the use of off-site retention. The portion of the SWRV that a regulated site does not retain on-site is termed the Off-Site Retention Volume (Offv), and the following are options for achieving Offv:

- Use Stormwater Retention Credits (SRCs), each of which corresponds to 1 gallon of retention for 1 year;
- Pay DOEE's in-lieu fee (ILF), the cost of which corresponds to 1 gallon of retention for 1 year; or
- A combination of the above.

The owner of a regulated site may use SRCs that the owner has generated or purchased on the private market. Contact information for SRC sellers is available in the SRC and Offv Registry at <https://doee.dc.gov/src>. Interested buyers may also list their contact information in the SRC and Offv Registry.

SRC buyers and sellers negotiate the terms of a transaction between themselves, but the transaction is not complete until DOEE has approved it. DOEE's approval is required so DOEE can effectively track ownership and use, including preventing fraudulent use of SRCs and publicly sharing the price at which SRCs sell.

The stormwater management plan (SWMP) for a major regulated project opting to use off-site retention must state the total Offv, but the SWMP need not state whether the site owner will meet the Offv with SRCs or ILF. The site owner has flexibility to change this option from year to year. This Offv, along with related requirements for sites in the Anacostia Waterfront Development Zone (AWDZ), will be recorded in the declaration of covenants filed for the property. Whether using ILF or SRCs, they must be in use as of the successful completion of DOEE's final inspection at the end of the construction process.

Owners of regulated sites are responsible for Offv on an ongoing basis beginning with DOEE's final construction inspection, just as they must maintain any on-site stormwater BMPs on an ongoing basis. In other words, a site's Offv must be achieved for the life of the development, similar to paying a lease or utility fee. A site's Offv must be achieved in a minimum of one-year increments, although it can be achieved for multiple years at once by using sufficient SRCs, paying sufficient ILF, or a combination of the two. However, if in the future additional green infrastructure is built on-site to reduce or eliminate the Offv, the site owner is no longer required to achieve that volume off site on an ongoing basis.

SRCs may be banked indefinitely. The 1-year lifespan of an SRC or ILF payment begins once it is used to satisfy Offv. Once SRCs have been used or sold, they remain valid even if the owner of the retention practices for which SRCs were certified fails to maintain them. Note, however, that there are consequences for original SRC owners who fail to maintain retention practices for which SRCs have been certified, as discussed in Chapter 7, “Generation, Certification, Trading, and Retirement of Stormwater Retention Credits” and Appendix E - Stormwater Retention Credit Forms (Certification, Trading, and Retirement).

Each SRC has a unique serial number and DOEE tracks the generation, transfer, use, and retirement of SRCs. If a site owner fails to satisfy an Offv obligation, DOEE will automatically assess ILF with penalties for late payment. DOEE may also take other action, including enforcement, against a regulated site for failure to comply with Offv.

## **6.2 Minimum On-Site Retention Requirement**

The minimum on-site requirement for a project is depends on the site location within:

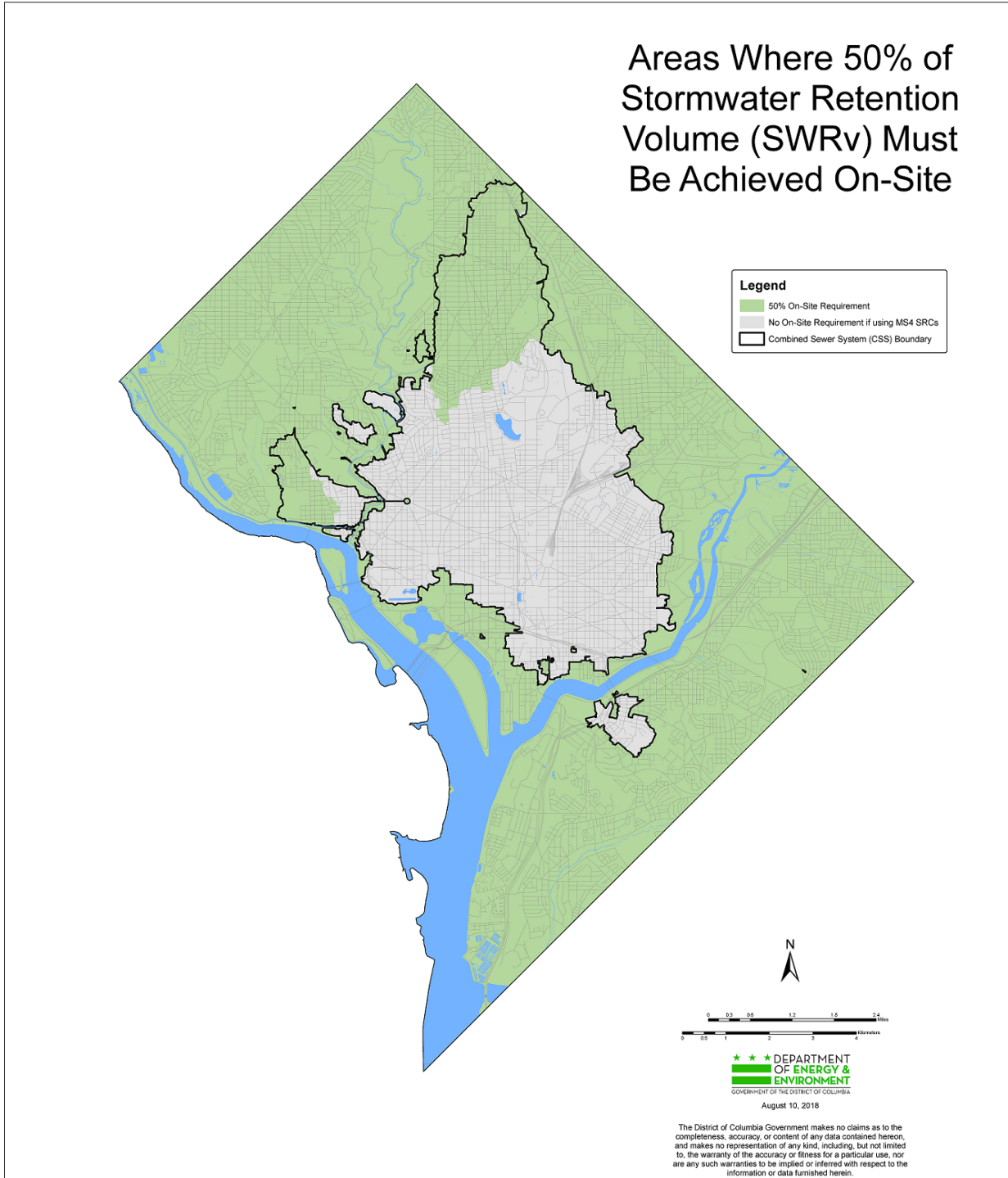
- Areas served by the Combined Sewer System (CSS) in a sewershed where Combined Sewer Overflows (CSOs) will be reduced with storage tunnels;
- Areas served by the CSS in a sewershed where CSOs will be reduced with green infrastructure; or
- Areas served by the Municipal Separate Storm Sewer System (MS4) or that drain directly to a waterbody.

These areas are shown in Figure 6.1 and in the Stormwater Database.

Regulated projects in areas that drain to the portion of the CSS where CSOs will be reduced with storage tunnels have no on-site minimum requirement if they exclusively use SRCs generated outside the CSS or pay ILF to meet their Offv requirement.

All other sites must achieve at least 50% of the SWR<sub>v</sub> using on-site stormwater BMPs. If it is technically infeasible or environmentally harmful to achieve this 50% minimum requirement in the MS4, direct drainage areas, or in the CSS areas where CSOs will be reduced with GI, sites may request relief from extraordinarily difficult site conditions, which is subject to approval by DOEE.

Any portion of the SWR<sub>v</sub> that is not met on site must be met off-site by using SRCs or paying ILF.



**Figure 6.1** Areas where 50% of SWRv must be achieved on site.

### 6.3 Off-Site Retention via Stormwater Retention Credits

One SRC satisfies 1 gallon of Offv for 1 year. To use SRCs to meet Offv, a regulated site owner must submit an application to DOEE using the Stormwater Database as described in Appendix D

- Off-Site Retention Forms for Regulated Sites. The application must identify the SRCs that will be used and may cover multiple years of Offv. The application must be submitted 4 weeks in advance of the planned date of use (e.g. 4 weeks prior to the Final Construction Inspection or 4 weeks prior to the end of the current Offv compliance period).

DOEE will approve the use of the SRCs after verifying SRCs ownership and other information in the application. For sites with an Offv requirement, DOEE will not sign off on a final inspection at the end of the construction process until it has approved the application and verified that Offv is achieved. The 1-year lifespan of the SRCs begins as of the date the SRCs are used to meet the Offv (i.e. the final construction inspection and every year thereafter).

If a lapse in Offv compliance occurs because DOEE has not received an ILF payment or an application to use SRCs, DOEE shall provide notice to the regulated site owner and charge ILF with a 10% late fee. If the site owner does not satisfy the Offv obligation within 30 days of DOEE's notice, DOEE may apply any unused SRCs the site owner has to the Offv that is out of compliance. DOEE may also take enforcement action against a regulated site that fails to comply with Offv.

Generally, the use of an SRC is not restricted by watershed. However, AWDZ sites that use SRCs that were generated outside the Anacostia Watershed must use 1.25 SRCs for every gallon of Offv. The watershed where SRCs are generated is stated in the SRC and Offv Registry and included in the SRC Serial Number.

The use of an SRC may be restricted by sewershed. The sewershed where SRCs are generated is stated in the SRC and Offv Registry. Areas that do not drain to the CSS will drain either to the MS4 or drain directly to a waterbody. For simplicity in the following list and in Table 6-1, these areas are all referred to as MS4 areas. This is also how they are labeled in the SRC and Offv Registry. Projects are subject to the following restrictions:

- Projects that use SRCs to meet Offv for a site in the CSS that achieves at least 50% of the SWRV on site may use any SRC.
- AWDZ projects that use SRCs to meet Offv must use SRCs generated in the MS4.
- Projects that use SRCs to meet Offv for a site in the MS4 must use SRCs generated within the MS4 area. This requirement is waived for site owners who generate their own SRCs if the SRCs are generated from a SWMP approved by April 30, 2020 and are used to meet an Offv approved by DOEE by April 30, 2020. This requirement is also waived if the SRCs are purchased in accordance with a contract signed by April 30, 2020.
- Projects that use SRCs to meet Offv for a site in the CSS areas where CSOs will be reduced with storage tunnels and that achieve less than 50% of the SWRV on site must use SRCs generated within the MS4 area. This requirement is waived for the generation and use of SRCs for projects that are part of the same common plan of development.
- Projects that use SRCs to meet Offv for a site in the CSS areas where CSOs will be reduced with green infrastructure that achieve less than 50% of the SWRV on site must use either:

- ◆ SRCs generated within the MS4 area; or
- ◆ SRCs generated within the CSS areas where CSOs will be reduced with green infrastructure.

The following table summarizes the SRCs from each sewershed that a regulated site may use.

**Table 6-1 SRCs that a Site Can Use**

Regulated Site Location	Amount of SWRv Achieved On-Site	SRCs that may be Used
AWDZ sites*		SRCs from MS4**
MS4	>=50%	SRCs from MS4***
MS4	<50% *	SRCs from MS4***
CSS areas where CSOs are reduced with GI	>=50%	Any SRC
	<50% *	<ul style="list-style-type: none"> <li>• SRCs from MS4</li> <li>• SRCs from CSS areas where CSOs are reduced with GI</li> </ul>
CSS areas where CSOs are reduced with storage tunnels	>=50%	Any SRC
	<50%	SRCs from MS4

\* Relief from extraordinarily difficult site conditions is required.

\*\*AWDZ sites must use 1.25 SRCs for every gallon of Offv if SRCs are generated outside the Anacostia River watershed. Refer to Chapter 2 to determine if the site is an AWDZ site. Relief from extraordinarily difficult site conditions is required.

\*\*\*Any SRC may be used in the MS4 if the SRC was self-generated from a SWMP approved within 6 months of the effective date of this provision and used to meet an Offv approved by DOEE within 6 months of the effective date of this provision. This requirement is also waived if the SRCs are purchased in accordance with a contract signed within 6 months of the effective date of this provision.

### Summary of Key Steps for Using SRCs

- Step 1:** Apply to use SRCs to satisfy Offv 4 weeks in advance of final construction inspection.
- Step 2:** Receive DOEE approval of use of SRCs.
- Step 3:** Schedule final construction inspection with DOEE (Steps 2 and 3 can be reversed).
- Step 4:** Pass final construction inspection and start use of SRCs.
- Step 5:** Four weeks before the end of the Offv compliance period, apply to use additional SRCs to satisfy Offv.
- Step 6:** Receive DOEE approval of use of SRCs.
- Step 7:** Repeat Steps 5 and 6 as necessary.

## 6.4 Off-Site Retention via In-Lieu Fee

Payment of 1-gallon-worth of ILF satisfies 1 gallon of Offv for 1 year. The fees rate is posted on DOEE's website at <https://doee.dc.gov/swregs> and is adjusted for inflation annually using the Urban Consumer Price Index published by the United States Bureau of Labor Statistics. The fee rate is also available in 21 DCMR § 501.

To use ILF to meet Offv, a regulated site must submit payment to DOEE and submit the Notification of ILF Payment form, using the Stormwater Database as described in Appendix D - Off-Site Retention Forms for Regulated Sites. The notification and payment must be submitted four weeks in advance of the planned date of use.

DOEE will confirm receipt of an ILF payment. DOEE will not sign off on a regulated site's final inspection at the end of the construction process until it has verified that its Offv is achieved. The 1-year lifespan of the ILF begins as of the date that it is used to meet Offv. At least 4 weeks before the end of the compliance period achieved with ILF payment, the regulated site owner must submit proof of payment of additional ILF or an application to use SRCs.

If a lapse in Offv compliance occurs because DOEE has not received an ILF payment or an application to use SRCs, DOEE shall provide notice to the regulated site owner and charge ILF, with a 10% late fee. If the site owner does not satisfy the Offv obligation within 30 days of DOEE's notice, DOEE may apply any unused SRCs the site owner has to the Offv that is out of compliance. DOEE may also take enforcement action against a regulated site that fails to comply with Offv.

## 6.5 Forms for Use of Off-Site Retention

Applicants must submit forms online using the Stormwater Database (<https://doee.dc.gov/swdb>). Appendix D - Off-Site Retention Forms for Regulated Sites contains paper applications that may also be submitted or viewed for reference:

- Application to Use Stormwater Retention Credits for Off-Site Retention Volume
- Notification of In-Lieu Fee Payment



# Chapter 7                      **Generation, Certification, Trading, and Retirement of Stormwater Retention Credits**

## **7.1    Stormwater Retention Credits Overview**

This chapter provides details on the eligibility requirements for certification of Stormwater Retention Credits (SRCs), the administrative process for certifying SRCs, the format for SRC serial numbers, the consequences for failure to maintain SRC-generating retention capacity, buying and selling SRCs, and voluntary retirement of SRCs. The chapter also explains how to calculate SRC eligibility and provides some example calculations. Additional resources and incentives related to the SRC program are available at <https://doee.dc.gov/src>.

The following background, covered elsewhere in this guidebook and the regulations, may be helpful in reviewing this chapter:

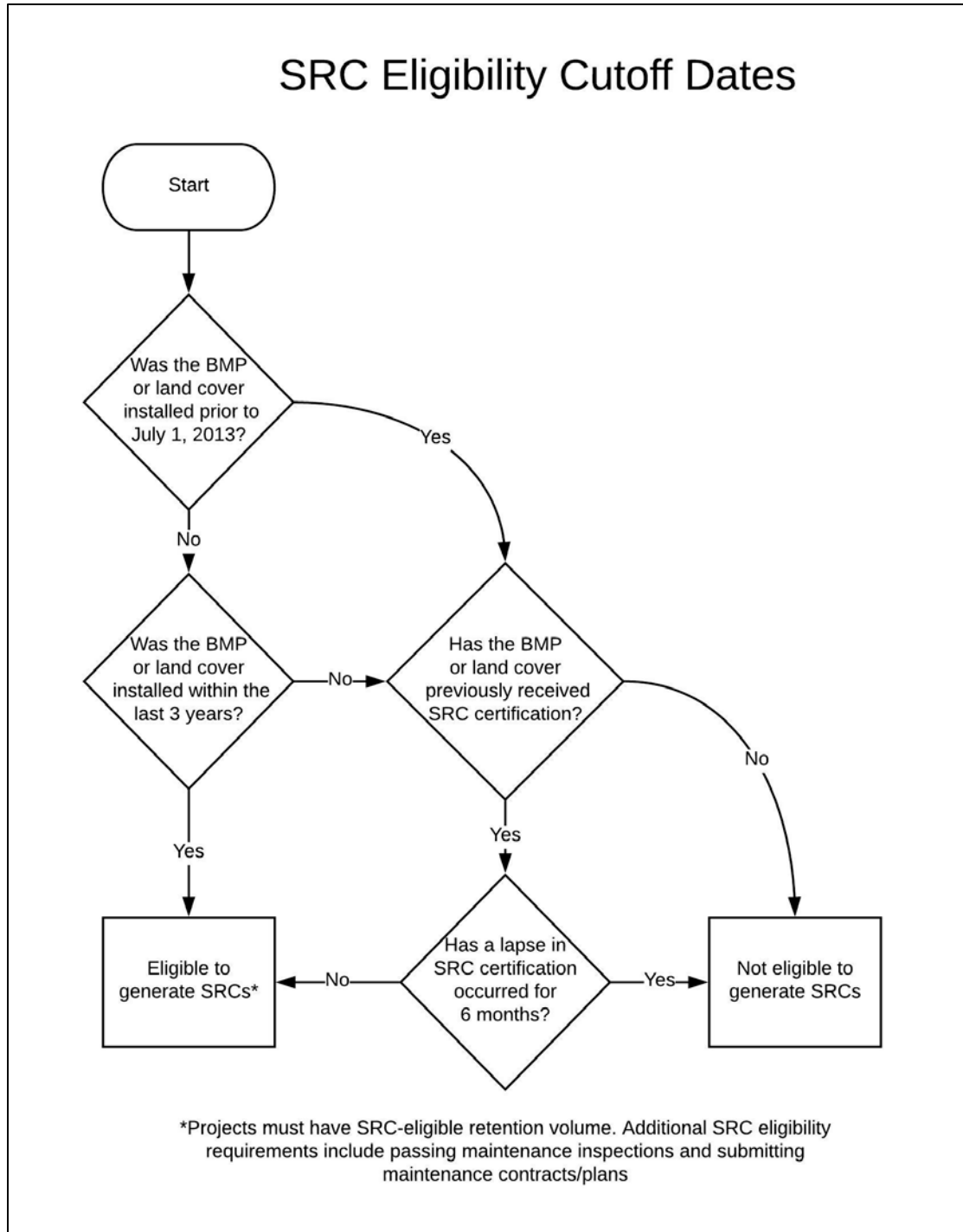
- One SRC is equal to 1 gallon of retention for 1 year.
- One SRC can be used by a major regulated project to achieve 1 gallon of its Off-Site Retention Volume (Offv) for 1 year.
- The clock starts on an SRC’s 1-year lifespan when it is used to satisfy an Offv.
- An unused SRC can be banked for future use without expiring.
- An SRC can be traded.
- An SRC can be voluntarily retired without being used.

## **7.2    Eligibility Requirements**

DOEE will certify SRCs for eligible stormwater best management practices (BMPs) and land cover in the District of Columbia. To be eligible, the retention capacity in a BMP or land cover must do the following:

- For unregulated projects or voluntary stormwater retrofits, achieve retention volume in excess of pre-project retention but less than the SRC ceiling;
- For regulated projects (see Chapter 2, “Minimum Control Requirements”), achieve retention volume in excess of regulatory requirements, but less than the SRC ceiling;
- Be designed and installed in accordance with a DOEE-approved Stormwater Management Plan (SWMP) and this Stormwater Management Guidebook;
- Pass a post-construction inspection and ongoing maintenance inspections; and
- Provide a maintenance contract or maintenance agreement(s) for ongoing maintenance.

Through July 31, 2020, any SRC-eligible BMP or land cover change installed since May 1, 2009, may apply to generate SRCs. After July 31, 2020, the BMP or land cover change providing retention capacity must have been installed on or after July 1, 2013, in order to be eligible. In addition, the first complete application for certification of SRCs must be submitted within 3 years of DOEE's final construction inspection of the BMP or land cover change. Once a project receives SRC certification from DOEE, the project shall be eligible to generate additional SRCs in future years as long as subsequent applications for certification of SRCs are submitted no later than 6 months after the end of the preceding period of SRC certification. Figure 7.1 includes a flowchart to assist in determining whether a project is eligible to generate SRCs based on its installation date and prior certification of SRCs.



**Figure 7.1 SRC Eligibility Cutoff Dates.**

### **7.2.2 Eligibility Requirements: Retention Volume**

For sites that are unregulated (all voluntary BMP installations, including those that are 5,000 square feet or greater), eligible retention volume must be achieved in excess of pre-project retention, as shown in Figure 7.2.

For all Major Land Disturbing and Major Substantial Improvement activities, the retention volume must exceed the Stormwater Retention Volume, as shown in Figure 7.2.

For sites that triggered the District's 1988 stormwater management regulations, the retention volume must exceed the treatment requirement for that project.

In all cases, DOEE shall not certify SRCs for retention capacity in excess of the runoff volume expected to occur from a 1.7-inch rainfall event ("SRC Ceiling;" see Figure 7.2).

This chapter provides guidance on calculating the volume of retention capacity that is eligible for SRC certification. An SRC-calculation spreadsheet is available at <https://doee.dc.gov/src>, and SRC calculations are performed by the Stormwater Database.

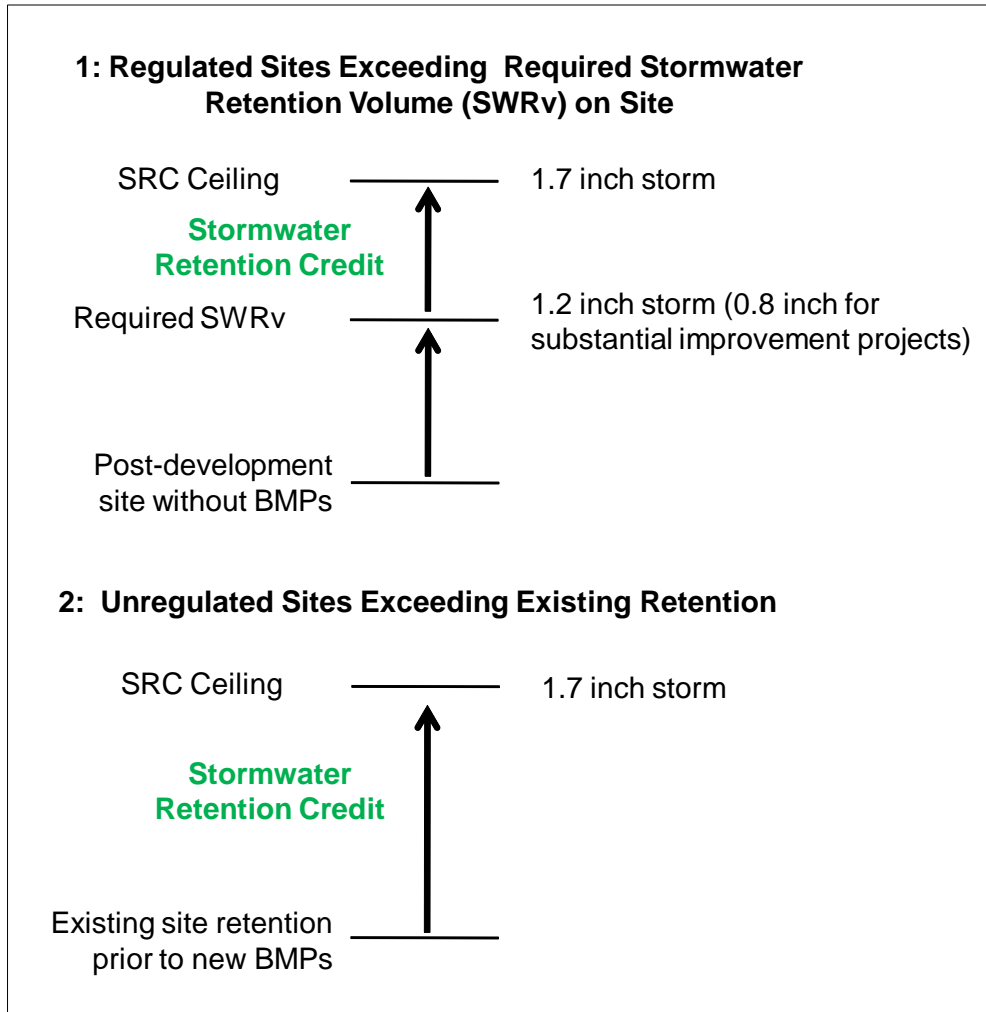


Figure 7.2 Retention volume eligible to earn SRCs.

### 7.2.3 Eligibility Requirements: Design and Installation

To be eligible for SRC certification, retention BMPs or land cover changes must be designed and installed according to a DOEE-approved SWMP, with an as-built SWMP submitted to DOEE.

If voluntary BMPs or land cover changes were installed without obtaining DOEE approval of a SWMP prior to installation, this retention capacity may still be eligible to earn SRCs. In such cases, DOEE will require an as-built SWMP stamped by a professional engineer licensed in the District of Columbia, as well as documentation of existing site conditions prior to the installation of the retention capacity. DOEE will consider such Applications for Certification of SRCs on a case-by-case basis and will determine eligible retention capacity in accordance with the specifications in this guidebook.

#### **7.2.4 Eligibility Requirements: Inspection**

To be eligible for SRC certification, retention BMPs and land cover changes must pass DOEE's post-construction inspection and continue to pass inspections on an ongoing basis. DOEE typically inspects BMPs every 3 years but may also conduct unscheduled inspections of retention capacity, on a random basis or as a result of a potential problem that is identified by DOEE or the public.

#### **7.2.5 Eligibility Requirements: Maintenance**

To be eligible for SRC certification, retention capacity must be maintained in good working order, as specified by DOEE. In an application for certification of SRCs, the proposed SRC owner (who becomes the original SRC owner once DOEE certifies the SRCs) signs a statement swearing to maintain the retention capacity for the period of time for which SRC certification is requested (1 to 3 years at a time, as requested by the applicant). To demonstrate the commitment to maintenance, the applicant must submit a current maintenance contract for the time period for which SRC certification is requested. Alternatively, applicants may conduct this maintenance themselves if they must demonstrate that they have the expertise and capacity to conduct the maintenance. The applicant shall submit the maintenance contract or other documentation of expertise and capacity as an attachment to the application for certification of SRCs. The maintenance contract or documentation is subject to review and approval by DOEE to ensure that it meets requirements outlined in the approved SWMP and Chapter 3 Stormwater Best Management Practices (BMPs) of this guidebook and must be in place for the entire period of SRC certification beginning with the date of the application.

### **7.3 Certification of Stormwater Retention Credits**

#### **7.3.1 Certification of SRCs: Process**

Required supporting documentation for the initial application includes DOEE approval of an SWMP, as-built SWMP, and a signed maintenance agreement or contract. Applications for retention capacity installed without prior DOEE approval of a SWMP must also provide documentation of site conditions prior to installation, including land cover type and existing retention BMPs. The BMP or land cover change providing eligible retention capacity must pass its most recent DOEE post-construction inspection, and the application to certify SRCs must be submitted within 6 months of the date of that inspection.

The application form for certification of SRCs is available in the Stormwater Database (<https://doee.dc.gov/swdb>). Through the form, DOEE receives information that is necessary to track and record generated SRCs. Such information includes the address of the site with eligible retention capacity, the owner of proposed SRCs, and the owner's agent, among other information. DOEE will not accept applications until the applicant obtains all SWMP and BMP approvals from DOEE..

DOEE will review the application and supporting documentation to make a determination as to the number of SRCs to certify. DOEE will send its response to the proposed SRC owner listed on the application for certification. DOEE expects that the proposed SRC owner would likely be

both the owner of the retention capacity and the owner of the property, but recognizes that this may not always be the case. If the proposed SRC owner is not the property owner, the proposed SRC owner must include documentation of the right to own the SRC applied for.

DOEE will certify up to 3 years' worth of SRCs for eligible retention capacity (the 3-year period is based on DOEE's typical 3-year inspection cycle). DOEE will assign each SRC a unique serial number for tracking purposes. At the end of that 3-year period, the owner may apply for another 3 years' worth of SRCs. For example, for 1,000 gallons of eligible retention capacity, DOEE will certify up to 3,000 SRCs initially and an additional 3,000 SRCs at the beginning of each subsequent 3-year period, as long as the eligibility requirements continue to be met.

An applicant should only apply for certification of SRCs corresponding to the period for which maintenance is planned. For example, if requesting 3 years' worth of SRCs, the application should provide a maintenance contract that lasts for 3 years. In applying for SRCs, an applicant commits to the maintenance of the retention capacity for the time period for which SRC certification is requested. Failure to maintain SRC-generating retention capacity is discussed below.

An applicant who wishes to have SRCs certified after the initial period of certification shall submit an additional application for certification of SRCs. The required supporting documentation for this resubmittal is a current maintenance contract or documentation of ongoing expertise and capacity to conduct the maintenance. Applicants must pass a DOEE inspection within the 6 month period prior to their application submission.

**Key Milestones for the Generation of SRCs:**

1. Receive DOEE approval of the proposed SWMP.
2. Install BMPs and/or land covers.
3. Pass DOEE's post-construction inspection.
4. Submit an as-built SWMP.
5. Within 3 years of passing DOEE's post-construction inspection submit an application for DOEE certification of SRCs, including a current maintenance contract or documentation of expertise and capacity to conduct maintenance (if more than 6 months has passed since the post-construction inspection, then another DOEE inspection is required).
6. Receive DOEE certification for up to 3 years' worth of SRCs.
7. Maintain retention capacity and pass subsequent inspections.\*
8. Up to 3 months before the end of the certification period, and within 6 months of the most recent maintenance inspection, submit an application for DOEE certification of SRCs, including a current maintenance contract or documentation of expertise and capacity to conduct maintenance.\*
9. Receive DOEE certification for up to 3 years' worth of additional SRCs.\*

\*Steps 7, 8 and 9 can be repeated indefinitely as long as the project does not lapse in SRC certification for more than 6 months.

### 7.3.2 Certification of SRCs: DOEE-Funded Projects

If a project received funding from DOEE, then DOEE shall limit the SRC eligibility. DOEE will certify only 50% of the SRCs for which the project would otherwise be eligible. For that period of certification, DOEE will multiply the number of SRCs that would have otherwise been certified by the annual average SRC market price to determine the amount of funds recouped by DOEE (although no payment to DOEE is made). Once DOEE recoups its funding in full, the project may generate 100% of the SRCs for which it is eligible.

For example, if DOEE provided \$5,000 to fund a project eligible to generate 1,000 SRCs per year, DOEE would apply the limitations policy until it recouped \$5,000. See Table 7-1.

**Table 7-1 Standard Bioretention Design Retention Value and Pollutant Removal**

Year	SRC Eligibility	SRCs Certified	SRCs Withheld	Average Price (Hypothetical)	Value Recouped	Value Recouped to Date
1	1,000	500	500	\$1.50	\$750	\$750
2	1,000	500	500	\$2.00	\$1,000	\$1,750
3	1,000	500	500	\$2.00	\$1,000	\$2,750
4	1,000	500	500	\$1.50	\$750	\$3,500
5	1,000	500	500	\$1.00	\$500	\$4,000
6	1,000	500	500	\$2.00	\$1,000	\$5,000
7	1,000	1,000	-	-	-	-

DOEE's policy of certifying SRCs for DOEE-funded projects is summarized here for the reader's convenience. The policy is available at <https://doee.dc.gov/src> and is subject to revision.

### 7.4 Format of SRC Serial Numbers

SRC serial numbers are based on the following format:

Beginning of certification year (yyyymmdd)	-	Major and Sub drainage (A, R, or P and 2 digits)	-	SWMP number (5 digits)	-	Individual gallon of capacity (6 digits)
---	---	---	---	---------------------------	---	---

For example, a proposed SRC owner submits a complete application for certification of SRCs on January 1, 2014, for 1,000 gallons of eligible retention capacity located in the Watts Branch sub-drainage of the Anacostia River. The retention capacity was installed in accordance with a DOEE-approved SWMP with "1400" as the identification number. After approving the application for 3 years' worth of SRCs, DOEE would issue 3,000 SRCs as follows:



*1,000 SRCs*    *20190101-A18-01400-000001 -*  
*20190101-A18-01400-001000*

*1,000 SRCs*    *20200101-A18-01400-000001 -*  
*20200101-A18-01400-001000*

*1,000 SRCs*    *20210101-A18-01400-000001 -*  
*20210101-A18-01400-001000*

## **7.5 Failure to Maintain Retention after Certification of Stormwater Retention Credits**

Sites need not file a declaration of covenants for the maintenance of retention capacity for which DOEE has certified SRCs. However, DOEE will not certify additional SRCs for retention capacity that is not maintained. An original SRC owner who fails to maintain a BMP or land cover that generates SRCs is required to compensate for the SRCs certified for the time period of the maintenance failure by one of the following means:

1. Forfeiting those SRCs by applying to retire them (if they have not been sold or used);
2. Purchasing and retiring replacement SRCs; or
3. Paying ILF to DOEE.

## **7.6 Buying and Selling Stormwater Retention Credits on the Market**

Each SRC has a unique serial number, and DOEE tracks the ownership and use of each SRC. SRC owners may list SRCs for sale in the SRC and Offv Registry in the Stormwater Database. Before the ownership of an SRC can be officially transferred, DOEE must approve a completed application for transfer of SRC ownership in order to verify the ownership and status of the SRCs. The new owner of the SRCs cannot use the SRCs to meet an Offv until DOEE has approved the application.

SRCs can be banked for future use without expiring. The 1-year lifespan of an SRC begins once it is used to achieve an Offv.

### **Key Milestones in Transfer of SRC Ownership:**

1. Advertise SRCs for sale through the SRC and Offv Registry in the Stormwater Database.
2. Negotiate terms of transfer/contract between buyer and seller.
3. Submit application for transfer of SRC ownership to DOEE.
4. Receive DOEE confirmation of transfer of SRC ownership.

SRCs may also be sold to DOEE through the SRC Price Lock Program, subject to the availability of funds. Full details are available at <https://doee.dc.gov/src>.

## **7.7 Voluntary Retirement of Stormwater Retention Credits**

An SRC owner can request that an SRC be retired by submitting an application to retire SRCs.

## 7.8 Quitting the Obligation to Maintain Retention for Stormwater Retention Credits

An original SRC owner can quit the obligation to maintain retention capacity for which an SRC is certified. If the SRC has not been sold or used to satisfy an Offv, the owner may submit an application to retire the SRC. If the SRC was sold or used, the original owner may retire another SRC in its place or pay ILF to compensate for the retired SRC.

## 7.9 Calculation of Stormwater Retention Credits

A person may use DOEE's SRC Financial Return Calculator to estimate the retention capacity that is eligible for SRC certification. The SRC spreadsheet is available at <https://doee.dc.gov/src>. The calculator is a planning and estimation tool only. DOEE does not guarantee financial return, SRC eligibility, or other results.

Use of the SRC calculator spreadsheet is discussed below. Calculation of the storage and retention volume of BMPs and land cover changes are described in Chapter 3 and Appendix A - Compliance Calculations and Design Examples. If complete site, construction, and financial information is not available, the tool will use assumptions to provide a rough estimate.

The final calculation of SRC eligibility must be determined using the Stormwater Database when the SWMP information is submitted for review. Use of the Stormwater Database is discussed in Appendix A - Compliance Calculations and Design Examples, and at <https://doee.dc.gov/swdb>. As discussed above, retention capacity must also meet eligibility requirements for design and installation, inspection, and maintenance in order for DOEE to certify SRCs.

The steps given below are meant to be followed while working with DOEE's SRC Financial Return Calculator. Note that **only entry of input data is required by users**—no manual calculations are required. In several sections, you may leave entries blank

Additional instructions are available within the Financial Return Calculator.

### ***Step 1:* Enter General Project Information**

- Input the type of project (voluntary retrofit or regulated)
- For voluntary projects, identify whether the project is in the MS4, receives DOEE funding, and/or participates in the SRC Price Lock Program. For regulated projects, identify the type of activity the site is undergoing (as described in Chapter 2).
- Identify the total project area or limit of disturbance.

### ***Step 2:* Enter the pre- and post-project land cover.**

- Input the area of each pre- and post-project land cover, including natural cover, compacted cover, impervious cover, and BMP cover. Guidance for various land covers is provided in Appendix O - Land Cover Designations and Table A.1 of Appendix A - Compliance Calculations and Design Examples.
- Automatic background calculations determine retention provided by land cover. This is equivalent to the abstraction provided by the land, determined by modifying the formula for calculating the SWRV. The calculation applies a retention coefficient (1.0 for natural cover, 0.75 for compacted cover, 0.05 for impervious cover, and 0.05 for BMP cover) to each of the land cover areas, using the 1.7-inch storm depth.
- If the site has pre-project BMPs, they will need to be entered (following the instructions for proposed BMPs, below).

***Step 3: Enter proposed BMPs***

- Select the type(s) of BMPs that are proposed and identify the contributing drainage area (CDA) to the BMPs, including natural cover, compacted cover, impervious cover, and BMP cover. Guidance for various land covers is provided in Table A.1 and Appendix O - Land Cover Designations.
- Automatic background calculations determine runoff from the CDA. The calculation applies a runoff coefficient (0.00 for natural cover, 0.25 for compacted cover, 0.95 for impervious cover, and 0.95 for BMP cover) to each of the land cover areas, using the 1.7-inch storm depth.
- Enter the storage volume, receiving area, or number of trees planted, as appropriate for the BMP type. Refer to Chapter 3, “Stormwater Best Management Practices (BMPs)” for more information about determining these inputs.
- Automatic background calculations determine the retention volume achieved by the BMP.

***Step 4: Enter SRC Project Costs***

- Input your own financial data to improve the estimate of financial return on your SRC project.
- Input your own estimated SRC selling prices or use the calculator-populated estimates.

***Step 5: SRC Eligibility and Financial Summary***

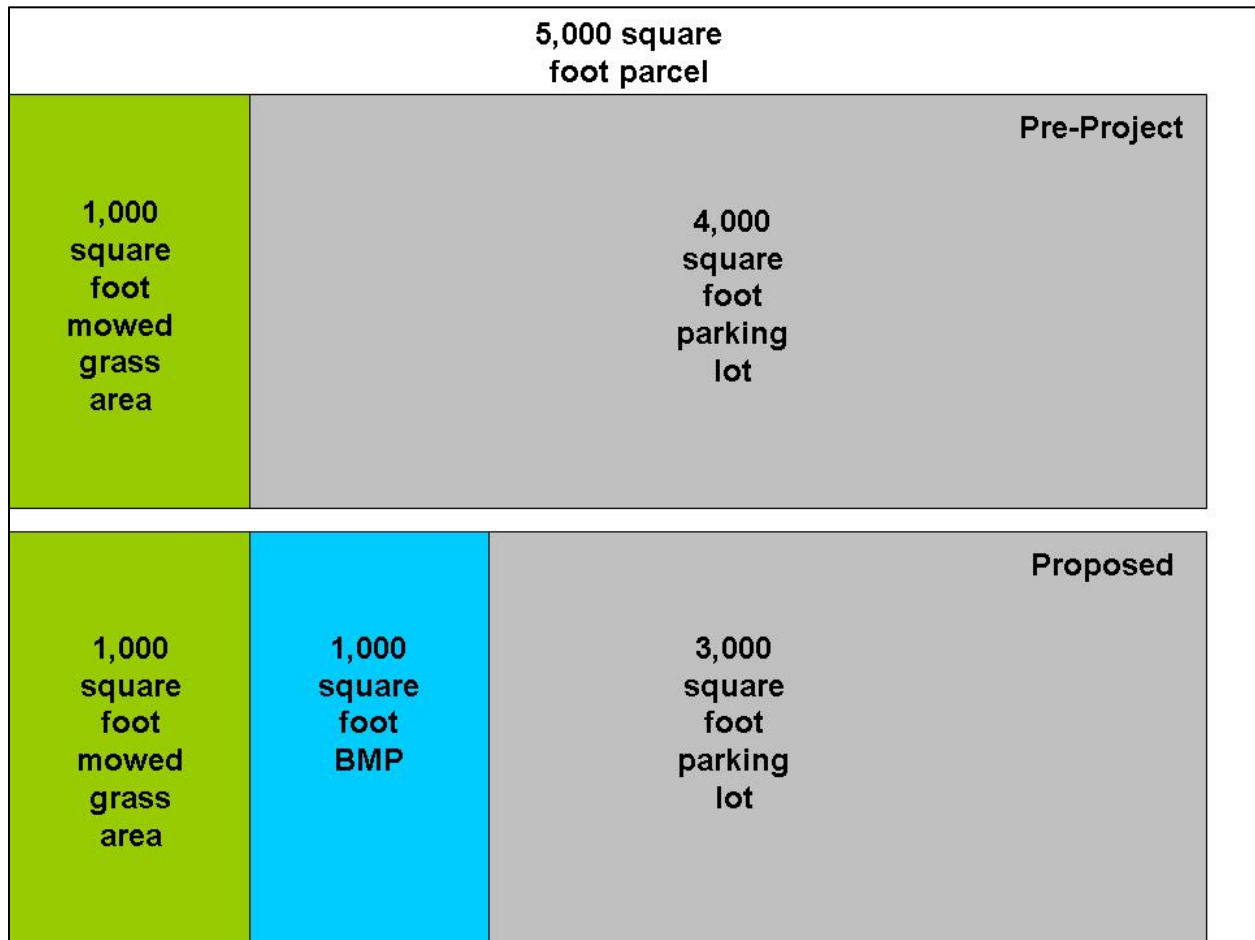
- The Financial Summary is not an official determination by DOEE. DOEE does not guarantee financial return, SRC eligibility, or other results.
- The SRC calculation is based on the proposed BMPs and land cover changes as entered into the calculator. Final calculation of the project’s SRC eligibility will be performed in the Stormwater Database.

## **7.10 Stormwater Retention Credit Calculation Scenarios**

This section includes SRC calculation scenarios for voluntarily-installed projects. Each scenario is accompanied by an example of how the design can be entered into the current version of the SRC Financial Return Calculator. Sites that trigger the stormwater management regulations should refer to Appendix A - Compliance Calculations and Design Examples.

**Scenario 1**

The site has a single SDA. The parcel is a 5,000-square foot rectangle (see Figure 7.3). There are two land covers on the site: a 4,000-square foot parking lot and an adjacent 1,000-square foot grass area that is regularly mowed (see Figure 7.4). The parking lot is defined as impervious surface and the mowed grass area is defined as compacted cover. The owner contemplates converting 1,000 square feet of parking surface into a bioretention, which is defined as impervious. Using Section 3.6 Bioretention, the proposed BMP is designed to retain 1,500 gallons (200.5 cubic feet) of runoff from the parking lot (see Figure 7.5). This project is eligible for 1,500 SRCs.



**Figure 7.3 Scenario 1.**

**Enter Land Cover Area by Type**

If land cover information is unavailable, the calculator will assume 100% impervious pre-project land cover and 90% impervious and 10% BMP post-project land cover.

Total Project Area (ft<sup>2</sup>):

Land Cover Type:	Natural	Compacted	Impervious	BMP	
Post-project (ft <sup>2</sup> )		1,000	3,000	1,000	5,000
Pre-project (ft <sup>2</sup> )			5,000		5,000

Figure 7.4 Land Cover Type.

**Enter Project BMP Design Information**

If BMP design information is unavailable, you may leave this page blank to assume BMPs manage the 1.7-inch storm across the Total Project Area. To estimate more accurate retention volume and project costs, enter BMP Type, BMP Subtype, and Contributing Drainage Area. If unavailable, Storage Volume information may be left blank.

BMP	BMP Subtype	Contributing Drainage Area (CDA) (ft <sup>2</sup> )				Storage Volume (ft <sup>3</sup> )	Retention Volume (ft <sup>3</sup> )	BMP Retention Vol. Achieved (ft <sup>3</sup> )	BMP Retention Vol. Achieved (gal)
		Natural	Compacted	Impervious	BMP				
1. Bioretention	Bioretention - Enhanced		1,000	3,000	1,000	200.5		200.5	1,500
2.									
3.									
4.									
5.									
6.									
7.									
8.									
9.									
10.									
11.									
12.									
<b>[BMP] CDA Total</b>			1,000	3,000	1,000				
<b>Project Area</b>			1,000	3,000	1,000			<b>Total R. (gal):</b>	1,500

Figure 7.5 BMP Design Information.

### Scenario 2

The site has a single SDA. The parcel is a 5,000-square foot rectangle and is divided between a 4,500-square foot parking lot and an adjacent 400-square foot grass area that is regularly mowed (see Figure 7.6). There is an existing bioretention (the land areas of all BMPs are considered impervious) covering 100 square feet and designed to retain 1,000 gallons (133.7 cubic feet) using Section 3.6 Bioretention. The parking lot is defined as impervious surface and the mowed grassy area is defined as compacted cover (see Figure 7.7). The owner contemplates converting

the grass area into bioretention and reducing the parking lot size by 1,000 square feet, with that area converted into mowed grass.

Using Section 3.6 Bioretention, the proposed 400-square foot BMP is designed to retain 1,500 gallons (200.5 cubic feet) of runoff from the parking lot in addition to the 1,000 gallons (133.7 cubic feet) retained by the original BMP. While the two BMPs retain a total of 2,500 gallons, only the 1,500 gallons of new retention is eligible for SRC certification.

In addition, the project reduces stormwater runoff through land cover changes. The removal of 1,000 square feet of impervious surface, adjusted by the installation of a 400 square foot BMP in existing compacted land cover, results in a net conversion of 600 square feet of impervious surface to compacted land cover. This achieves a retention volume of 445 gallons. Altogether, this project is eligible for 1,945 SRCs (see Figure 7.8).

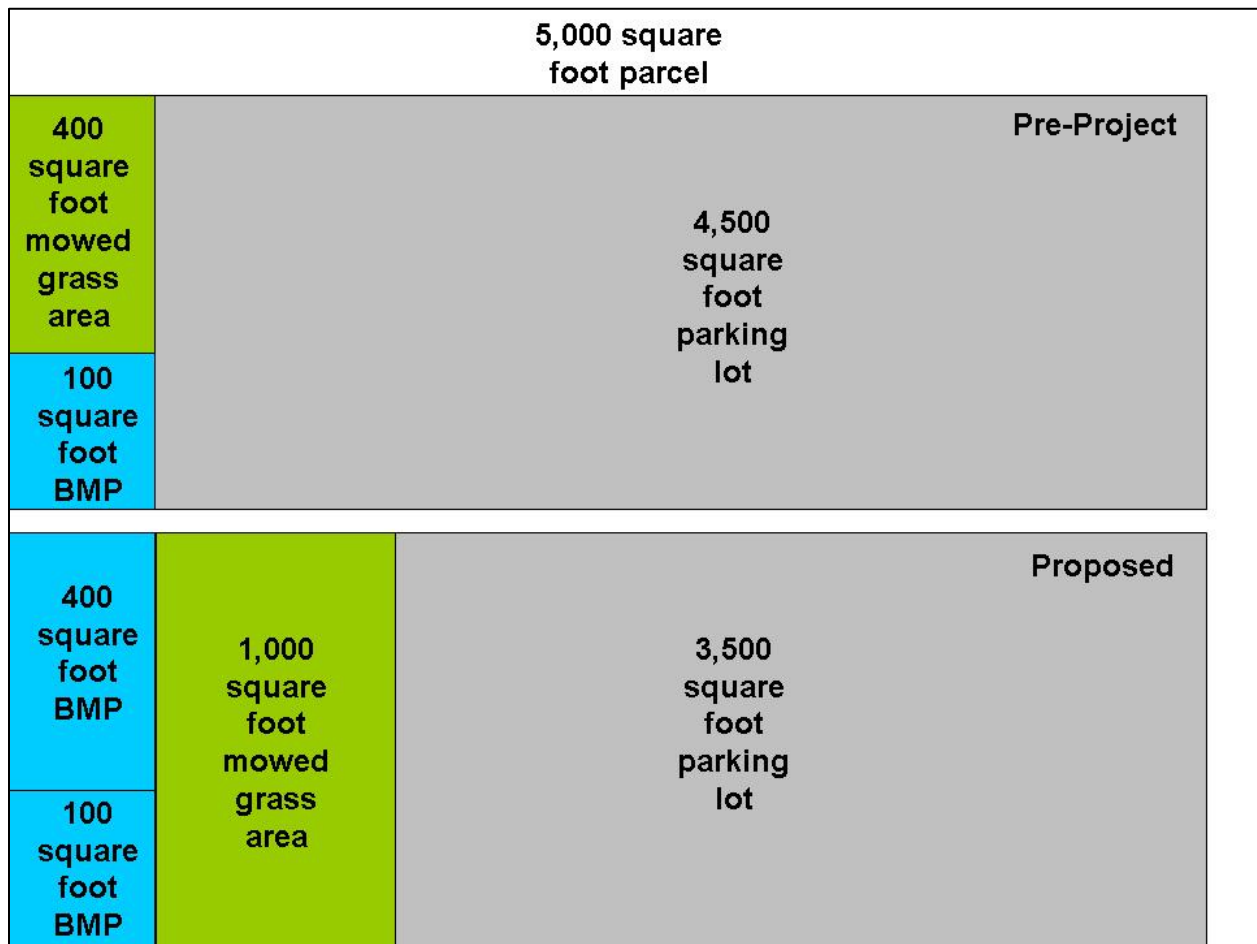


Figure 7.6 Scenario 2.

**Enter Land Cover Area by Type**  
If land cover information is unavailable, the calculator will assume 100% impervious pre-project land cover and 90% impervious and 10% BMP post-project land cover.

Total Project Area (ft<sup>2</sup>):

Land Cover Type:	Natural	Compacted	Impervious	BMP	
Post-project (ft <sup>2</sup> )		1,000	3,500	500	5,000
Pre-project (ft <sup>2</sup> )		400	4,500	100	5,000

Go Back
Continue

---

**Enter Pre-Project BMP Information**  
If existing BMP storage volume information is unavailable, the calculator will assume BMPs manage the 1.7-inch storm across the Contributing Drainage Area.

BMP	BMP Subtype	Contributing Drainage Area (CDA) (ft <sup>2</sup> )				Storage Volume (ft <sup>3</sup> )	BMP Retention Vol. Achieved (ft <sup>3</sup> )	BMP Retention (gal)
		Natural	Compacted	Impervious	BMP			
Bioretention	Bioretention - Enhanced		400	1,000	100	133.7	133.7	1,000

Figure 7.7 Land Cover and Pre-Project BMP Information.

**Enter Project BMP Design Information**  
If BMP design information is unavailable, you may leave this page blank to assume BMPs manage the 1.7-inch storm across the Total Project Area. To estimate more accurate retention volume and project costs, enter BMP Type, BMP Subtype, and Contributing Drainage Area. If unavailable, Storage Volume information may be left blank.

BMP	BMP Subtype	Contributing Drainage Area (CDA) (ft <sup>2</sup> )				Storage Volume (ft <sup>3</sup> )	BMP Retention Vol. Achieved (ft <sup>3</sup> )	BMP Retention Vol. Achieved (gal)
		Natural	Compacted	Impervious	BMP			
1. Bioretention	Bioretention - Enhanced		400	1,000	100	133.7	133.7	1,000
2. Bioretention	Bioretention - Enhanced		600	2,500	400	200.5	200.5	1,500
3.								
4.								
5.								
6.								
7.								
8.								
9.								
10.								
11.								
12.								
<b>BMP CDA Total</b>			1,000	3,500	500			
<b>Project Area</b>			1,000	3,500	500			
							<b>Total R<sub>v</sub> (gal):</b>	2,500

Return to Overview
Go Back
Continue

Figure 7.8 BMP Design Information.

### 7.11 Forms for Stormwater Retention Credits

Applicants must submit forms online using the Stormwater Database. Appendix E - Stormwater Retention Credit Forms (Certification, Trading, and Retirement) contains paper applications that may also be viewed for reference:

- Application for Certification of Stormwater Retention Credits
- Application for Transfer of Stormwater Retention Credit Ownership
- Application to Retire Stormwater Retention Credits





# Appendix A Compliance Calculations and Design Examples

## A.1 Stormwater Database and General Retention Compliance

Each regulated project must use the Stormwater Database for Stormwater Management Plan (SWMP) submittal to DOEE to demonstrate proper stormwater best management practice (BMP) selection and sizing to achieve the required volume of stormwater retention and/or water quality treatment. Online submittal through the Stormwater Database is required. While the Stormwater Database is used to provide site and plan information for SWMPs, Soil Erosion and Sediment Control Plans, Green Area Ratio (GAR) plans, and allow participation in the Stormwater Retention Credit (SRC) trading and RiverSmart Rewards discount program, this appendix only discusses SWMP submittal.

The Required Plan Compliance Sheet from the database must be included as part of the SWMP. All major regulated projects are required to address the Stormwater Retention Volume (SWRV), and major regulated projects in the Anacostia Waterfront Development Zone (AWDZ) are required to address the Water Quality Treatment Volume (WQTV), as described in Chapter 2, “Minimum Control Requirements.” The Stormwater Database can also be used, in addition to other hydrologic methods and models, to demonstrate compliance with detention obligations (see Section 2.6, “Control of 2-Year Storm,” Section 2.7, “Control of 15-Year Storm,” and Appendix I - - Acceptable Hydrologic Methods and Models.

This appendix discusses concepts and equations related to the Required Plan Compliance Sheets and provides several SWMP design examples.

Full instructions for the use of the Stormwater Database can be found at <http://doee.dc.gov/swdb>.

DOEE also provides a General Retention Compliance Calculator (GRCC) spreadsheet which can be used as both a learning and design tool for project engineers. The GRCC is an Excel file located on the DOEE website at <https://doee.dc.gov/swguidebook>. Instructions for using the spreadsheet can be found there as well.

## A.2 Compliance Calculations and Concepts

The following guidance explains calculations and concepts related to demonstrating compliance with DOEE’s stormwater management requirements. Many of these calculations and concepts are used on the Required Plan Compliance Sheets from the Stormwater Database. Several calculations are conducted internally in the Stormwater Database based on plan information entered into a project’s database record.

### Site Drainage Area Compliance Data

1. Regulatory Activities: As described in Section 2.2, “Regulated Site Definition and Examples,” major land disturbing activities and major substantial improvement activities will trigger the stormwater management requirements. Further descriptions of these activities can be found in that section.
2. Site Drainage Area Tabulation: Each site must be divided into individual site drainage areas (SDAs). Each SDA drains stormwater from the site to a single discharge point or sheet flows from a single area off the site. All area within a project’s Limit of Disturbance (LOD) must be counted in a SDA, along with the footprint of buildings or structures which are designated as major substantial improvement activities.
3. Site Drainage Area Land Cover: SDAs track the amount of pre-project and post-project land cover. Guidance for various land covers is provided in Appendix O - Land Cover Designations. Note: Counting the post-project land cover will be iterative as BMP sizing is performed and the area of both BMPs and other land cover types are adjusted. Vehicular access areas should be identified only if the site is in the MS4. Vehicular access areas are a sub-category of impervious cover; therefore, they must be included as a part of the total impervious cover area. The post-project land cover is used to determine the SWR<sub>v</sub> and WQT<sub>v</sub> (if applicable) as described in Table 2-1. The SWR<sub>v</sub> of each SDA is summed and used to determine the project’s retention requirement.
4. Public Right-of-Way SDAs and the Maximum Extent Practicable Process: SDAs in the public right-of-way (PROW) must be tabulated, and their SWR<sub>v</sub> summed, separately from SDAs not in the PROW. If the SWR<sub>v</sub> or WQT<sub>v</sub> is not met for a SDA in the PROW, the site may still comply if it follows the maximum extent practicable (MEP) process as described in Appendix B - Maximum Extent Practicable Process for Existing Public Right-of-Way.
5. Vehicular Access Area Required Volume: As noted in Section 2.3 Stormwater Retention Volume, for all vehicular access areas in the MS4, a minimum of 50% of the SWR<sub>v</sub> must also be retained or treated. This volume is calculated for each SDA as follows:

$$V = \frac{P \times Rv_I \times Av \times 0.5}{12}$$

where:

- $V$  = volume within the SDA from vehicular access areas that must be retained or treated (ft<sup>3</sup>)
- $P$  = regulatory rain event for SWR<sub>v</sub> (in.)
- $Rv_I$  = runoff coefficient for impervious cover (0.95)
- $Av$  = area of vehicular access area (ft<sup>2</sup>)
- 12 = conversion factor, converting inches to feet

6. Site Drainage Area Location Data: SDAs are assigned location designations depending on which sewershed it drains to: the Municipal Separated Stormwater Sewer System (MS4), the

Combined Sewer System (CSS) where combined sewer overflows (CSOs) will be reduced with green infrastructure, or the CSS from a sewershed where CSOs will be reduced with storage tunnels. Section 2.3, “Stormwater Retention Volume” describes how SWRV can be achieved depending on the sewershed location of the site.

**Best Management Practice (BMP) Compliance Data**

1. **BMP Tabulation and Land Cover:** Proposed stormwater BMPs are assigned to the SDA where the BMP is located. Land cover area within the BMP’s contributing drainage area (CDA) is tabulated the same as for a SDA.
2. **Maximum Retention Volume Received by the BMP,  $V_{max}$ :** The maximum retention volume received by the BMP ( $V_{max}$ ) represents the greatest retention volume for which a BMP can be credited. Regardless of the regulatory rainfall event that applies to the site, the volume calculated is based on a rainfall depth of 1.7 inches.

$$V_{max} = \frac{1.7 \times [(Rv_N \times N) + (Rv_C \times C) + (Rv_I \times (I + A_{BMP}))]}{12}$$

where:

- $V_{max}$  = volume received by the BMP from 1.7-inch rain event (ft<sup>3</sup>)
- $Rv_N$  = runoff coefficient for natural cover (0.00)
- $N$  = area of post-development natural cover (ft<sup>2</sup>)
- $Rv_C$  = runoff coefficient for compacted cover (0.25)
- $C$  = area of post-development compacted cover (ft<sup>2</sup>)
- $Rv_I$  = runoff coefficient for impervious cover (0.95)
- $I$  = area of post-development impervious cover (ft<sup>2</sup>)
- $A_{BMP}$  = area of BMP (ft<sup>2</sup>)
- 12 = conversion factor, converting inches to feet

3. **BMP Storage Volume:** This value refers to the total volume that can be retained by the BMP, determined using the related BMP storage volume calculations found in Chapter 3. This value is not necessarily the amount of volume which will receive retention credit.
4. **BMP Retention Value:** Depending on the category and sub-category of the BMP, a modifier value is applied to the BMP storage volume. For example, standard bioretention practices are assigned a retention value of 0.6.
5. **Volume Retained:** The stormwater volume that is credited for retention. This value is the lesser of  $V_{max}$  or the BMP storage volume multiplied by the BMP retention value.
6. **BMP Treatment Volume:** BMPs that have a less than 100% retention value and are accepted TSS treatment practices are assigned additional treatment volume. This volume is based upon the lesser of the runoff volume received by the BMP and the actual storage volume minus the volume retained.

7. Downstream BMPs and Treatment Trains: If more than one BMP is employed in series, any overflow volume from the 1.7-inch storm from upstream BMPs can be directed to a downstream BMP and applied to the downstream BMP's volume retained if any storage volume remains.

### Detention Calculations and Concepts

Detention requirements are discussed in Section 2.6, "Control of 2-Year Storm" and Section 2.7, "Control of 15-Year Storm." DOEE accepts the Adjusted Curve Number method for determining compliance with detention requirements, which takes into account the detention benefits of retention BMPs during storm events. The Stormwater Database automatically calculates these adjusted curve numbers for the 2-year, 15-year, and 100-year storms according to the storage BMPs proposed for a project. The procedure for performing these calculations is provided below:

1. Calculate a Weighted Curve Number for both pre-project and post-project conditions. Each land cover type is associated with a Natural Resource Conservation Service (NRCS) curve number (CN). Additional information on the NRCS CN method can be found in Appendix I - Acceptable Hydrologic Methods and Models.

### Weighted Curve Number

$$CN = \frac{(N \times 70) + (C \times 74) + (I \times 98)}{SA}$$

where:

<i>CN</i>	=	weighted curve number
<i>N</i>	=	area of natural cover (ft <sup>2</sup> )
<i>C</i>	=	area of compacted cover (ft <sup>2</sup> )
<i>I</i>	=	area of impervious cover (ft <sup>2</sup> )
<i>SA</i>	=	total site area (ft <sup>2</sup> )

2. Calculate the runoff without regard to BMPs.

### Potential Abstraction

$$S = \frac{1000}{CN} - 10$$

where:

<i>S</i>	=	potential abstraction (in.)
<i>CN</i>	=	weighted curve number

**Runoff with no Retention**

$$Q = \frac{(P - 0.2 \times S)^2}{(P + 0.8 \times S)}$$

where:

- $Q$  = runoff with no BMPs (in.)
- $P$  = precipitation depth for a given 24-hour storm (in.)
  - = 2-year storm (3.14 inches)
  - = 15-year storm (5.23 inches)
  - = 100-year storm (8.34 inches)
- $S$  = potential abstraction (in.)

3. Calculate the runoff with BMPs. This value is the runoff without BMPs minus the total storage volume provided by BMPs.

**Runoff with BMPs**

$$Q_{BMP} = Q - \frac{Sv_{DA} \times 12}{SA}$$

where:

- $Q_{BMP}$  = runoff with BMPs (in.)
- $Q$  = runoff with no BMPs (in.)
- $Sv_{DA}$  = total storage volume provided by BMPs for the site area (ft<sup>3</sup>)
- 12 = unit adjustment factor, feet to inches
- $SA$  = total site area (ft<sup>2</sup>)

4. The Adjusted Curve Number is the CN that results in the calculated runoff with the BMPs. This Adjusted Curve Number can be determined by a table lookup. The user finds the corresponding CN that results in  $Q_{BMP}$  runoff calculated in Step 3. The lookup table to determine the Adjusted Curve Number is provided in the GRCC. The table can also be user-generated in a spreadsheet program such as Excel.

### Adjusted Curve Number

$$\frac{(P - 0.2 \times S_{adjusted})^2}{(P + 0.8 \times S_{adjusted})} = Q_{BMP} \rightarrow \text{lookup table} \rightarrow CN_{adjusted}$$

$$S_{adjusted} = \frac{1000}{CN_{adjusted}} - 10$$

where:

$CN_{adjusted}$	=	adjusted curve number that will create a runoff equal to the site area runoff including BMPs
$P$	=	precipitation depth for a given 24-hour storm (in.)
	=	2-year storm (3.14 inches)
	=	15-year storm (5.23 inches)
	=	100-year storm (8.34 inches)
$S_{adjusted}$	=	adjusted potential abstraction based upon adjusted curve number (in.)
$Q_{BMP}$	=	runoff with BMPs (in.)

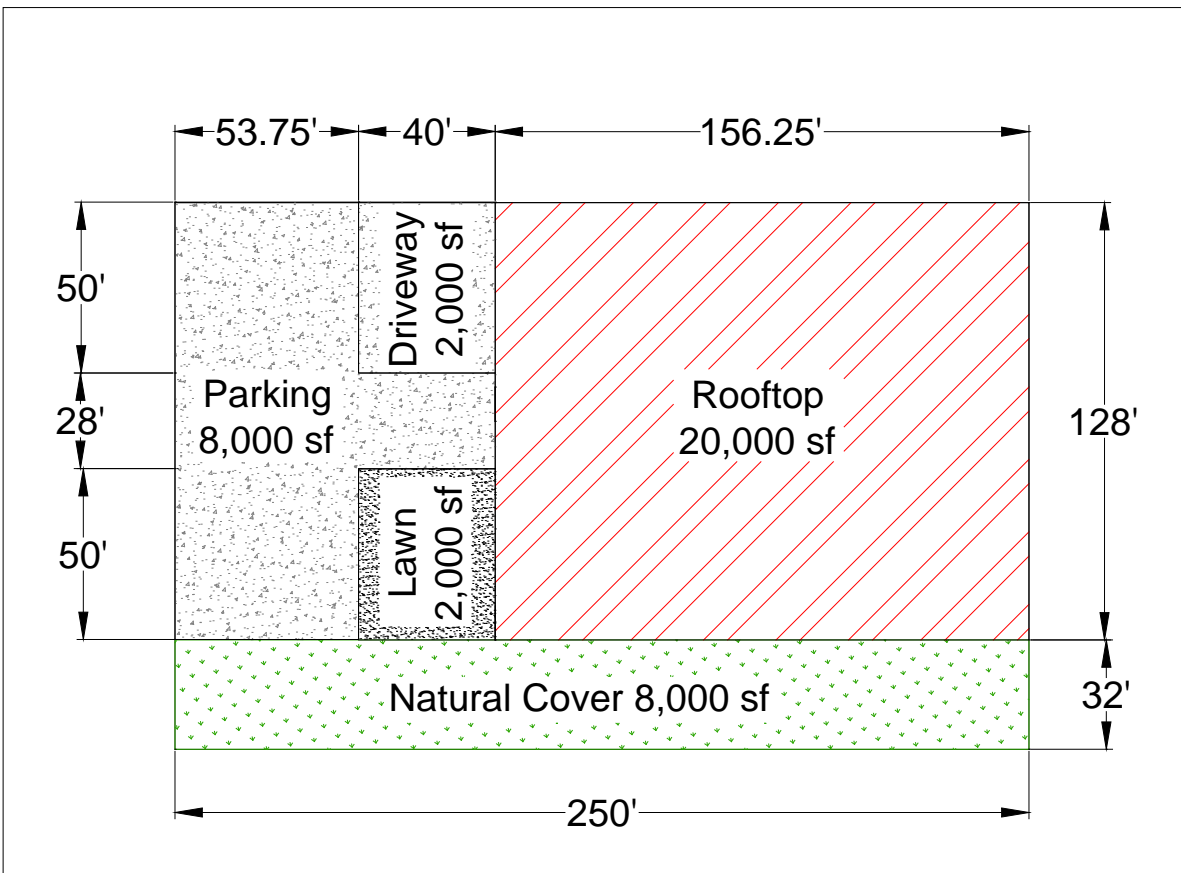
5. If the Adjusted Curve Number for the entire project for the 2-year storm event is less than or equal to pre-development conditions, then the 2-year detention requirement is met. If the Adjusted Curve Number for the entire project for the 15-year storm event is less than or equal to the pre-project Adjusted Curve Number, then the 15-year detention requirement is met.
6. If the Adjusted Curve Number is not less than its comparison CN, then additional storage is required. A project must demonstrate meeting detention requirements using an acceptable method from Appendix I - Acceptable Hydrologic Methods and Models.

### A.3 Design Examples

#### Design Example 1

**Step 1: Determine Design Criteria.**

Site Name	Anacostia Offices
Total Site Area	40,000 ft <sup>2</sup>
Natural Cover Area	8,000 ft <sup>2</sup>
Compacted Cover	2,000 ft <sup>2</sup>
Impervious Cover	30,000 ft <sup>2</sup>
Vehicular Access Areas	10,000 ft <sup>2</sup>
Is site located within the AWDZ?	No
Is site located within the MS4?	Yes
What type of activity is site undergoing?	Major Land-Disturbing



**Step 2: Determine the Retention and Treatment Requirements.**

Based on the design criteria above, Anacostia Offices has the following requirements:

$$SWRv = 2,900 \text{ ft}^3$$

**Step 3: Identify Site Constraints and BMP Restrictions.**

Key considerations for Anacostia Offices include the following:

- Site soils are contaminated, so infiltration is not allowed, and impermeable liners will be required for most BMPs.
- The commercial land use means that most BMPs are otherwise acceptable.

**Step 4: Select BMPs to Meet the Retention and Treatment Requirements.**

While there are numerous options for treatment of this site, two BMPs were selected: rainwater harvesting (R-1) for the rooftop and traditional bioretention (B-1) for any remaining rooftop runoff and the rest of the site. Since the site is contaminated, a liner is required and the enhanced bioretention option is not available.

The site will ultimately have one outlet point, and the selected treatment train is relatively simple, so the calculations can be performed with one SDA.

The first BMP selected is rainwater harvesting for runoff from the rooftop. The Rainwater Harvesting Retention Calculator should be used to determine the cistern size and the associated retention value. In the Rainwater Harvesting Retention Calculator, input 20,000 square feet as the CDA. For utilization of the rainwater, flushing toilets/urinals is selected as the use, and the appropriate values are entered. In this case, 475 people will use the building per day, Monday through Friday, 8 hours per day. On the Storage Volume Results sheet, the Available Storage Volume (Sv) is given for various tank sizes. The tables and graphs show that a 30,000-gallon underground tank (or series of tanks) would have an available storage volume of 2,501 cubic feet.

The BMP is assigned to SDA 1 with a 20,000-square-foot CDA and a storage volume of 2,501 cubic feet. The result is that 2,501 cubic feet of runoff is retained and 191 cubic feet remain. Since Standard Bioretention will be the next BMP in the series, the remaining runoff volume will then be directed to this BMP.

In addition to the overflow from the rainwater harvesting BMP, the bioretention area will receive runoff from the rest of the site. Through trial and error, it was determined that a 1,000-square-foot bioretention area would be sufficient to meet the retention requirement. This area will be taken from the compacted cover area and replaced by BMP cover. Compacted cover will now be 1,000 square feet, and BMP will be 1,000 square feet. The 8,000 square feet of natural cover will remain. Impervious cover directed to the bioretention area will be 10,000 square feet (the remaining impervious area after 20,000 square feet was removed for rainwater harvesting). There will also be 1,000 square feet of compacted cover and 1,000 square feet of BMP surface area directed to the bioretention area. Since the 10,000 square feet of impervious cover is made up of driveway and parking area, it is all classified as vehicular access area.

The vehicular access retention/treatment requirement is 475 cubic feet, and the total volume directed to the bioretention area, including the “overflow” from the rainwater harvesting BMP,



will be 1,707 cubic feet. The bioretention storage volume of 800 cubic feet is more than sufficient to address the vehicular access volume and leads to an exceedance of 82 gallons for the SWRV.

**Step 5: Size the BMPs According to the Design Equations.**

The size of the rainwater-harvesting cistern was already determined to be 30,000 gallons, although additional volume may be necessary for dead storage for a pump and/or freeboard.

To meet the bioretention criteria, the bioretention area is sized with 1.5 feet of filter media, 0.75 feet of gravel, and a 0.5-foot ponding depth. The bioretention cell sizing goal is 800 cubic feet.

**Step 5.1: Check the Filter Media Depth.**

Ensure that the filter media depth does not exceed the maximum in Table 3-19. The ratio of the surface area of the BMP (1,000 ft<sup>2</sup>) to the CDA (32,000 ft<sup>2</sup>) is 3.1%. The Rv for the CDA to the bioretention practice is 0.93. The maximum filter media depth allowed is 5.4 feet. As the bioretention was sized with 1.5 feet of filter media, it passes this check.

**Table 3.20 Determining Maximum Filter Media Depth (feet)**

SA:CDA (%)	RV <sub>CDA</sub>								
	0.25	0.3	0.40	0.50	0.60	0.70	0.80	0.90	0.95
0.5	6.5	6.5	6.5	6.5	6.5	6.5	6.5	6.5	6.5
1.0	5.0	5.5	6.0	6.5	6.5	6.5	6.5	6.5	6.5
1.5	3.5	4.0	5.0	6.0	6.0	6.5	6.5	6.5	6.5
2.0		3.0	4.0	4.5	5.5	6.0	6.0	6.5	6.5
2.5			3.5	4.0	4.5	5.0	5.5	6.0	6.0
3.0				3.5	4.0	4.5	5.0	5.5	5.5
3.5				3.0	3.5	4.0	4.5	5.0	5.0
4.0					3.0	3.5	4.0	4.5	4.5
4.5						3.5	3.5	4.0	4.0
5.0							3.5	4.0	4.0
5.5								3.5	3.5
6.0								3.0	3.5
6.5									3.0
7.0+									

**Step 5.2: Determine Storage Volume.**

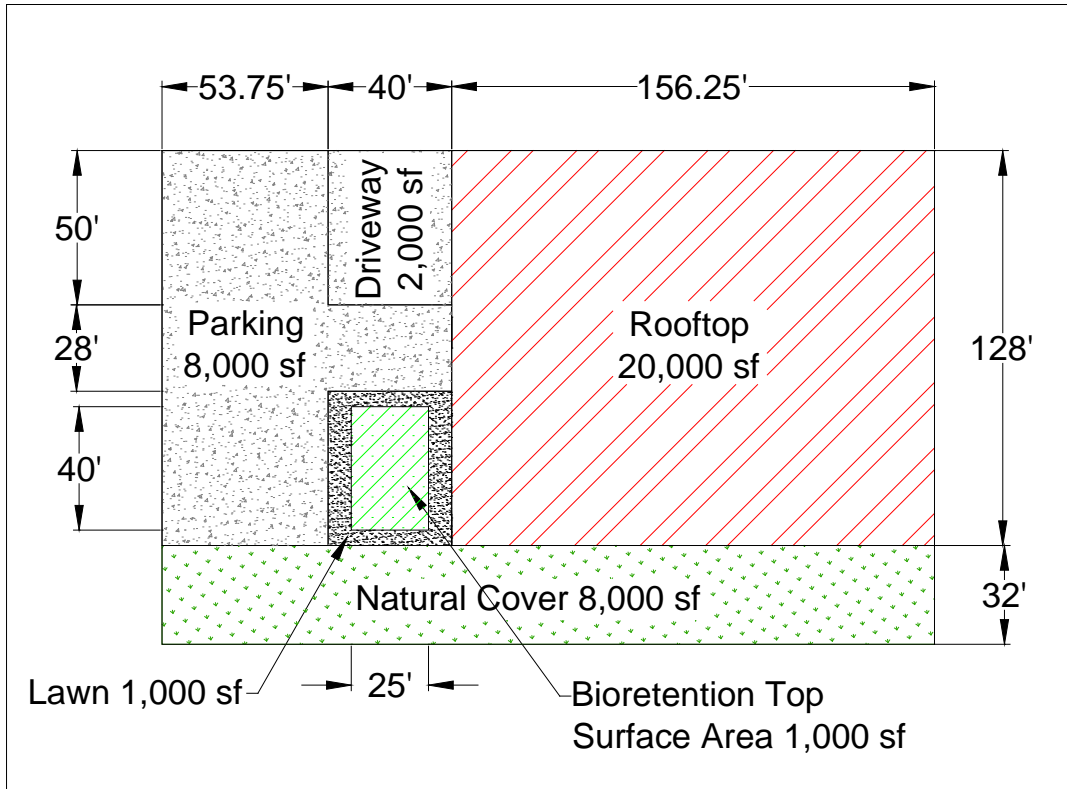
**Equation 3.5**

$$Sv = SA_{bottom} \times [(d_{media} \times \eta_{media}) + (d_{gravel} \times \eta_{gravel})] + (SA_{average} \times d_{ponding})$$

where:

$Sv$	=	total storage volume of bioretention (ft <sup>3</sup> )
$SA_{bottom}$	=	bottom surface area of bioretention (ft <sup>2</sup> )
$d_{media}$	=	depth of the filter media, including mulch layer (ft)
$\eta_{media}$	=	effective porosity of the filter media (typically 0.25)
$d_{gravel}$	=	depth of the underdrain and underground storage gravel layer, including choker stone (ft)
$\eta_{gravel}$	=	effective porosity of the gravel layer (typically 0.4)
$SA_{average}$	=	average surface area of the bioretention (ft <sup>2</sup> ) typically, where $SA_{top}$ is the top surface area of bioretention, $SA_{average} = \frac{SA_{bottom} + SA_{top}}{2}$
$d_{ponding}$	=	maximum ponding depth of the bioretention (ft)

Solving Equation 3.5 often requires an iterative approach to determine the most appropriate bottom surface area and average surface area to achieve the desired Sv. In this case, a bioretention with a 40-foot by 25-foot top area and 3H:1V side slopes will provide an  $SA_{top}$  of 1,000 square feet, an  $SA_{bottom}$  of 814 square feet, an  $SA_{average}$  of 907 square feet, and achieve an Sv of 1,003 cubic feet. This more than meets the goal of 800 cubic feet. If desired, the surface area of the practice could be reduced accordingly, or more SRCs could be generated with the excess volume.



**Step 6: Check Design Assumptions and Requirements.**

Key assumptions and requirements for this site include the following:

- Based upon the above design, the rainwater harvesting cistern will be 30,000 gallons, and the bioretention cell will require at least 1,000 square feet of surface area. The designer would need to ensure that space would be available for these BMPs on the site.
- The CDA for traditional bioretention must be 2.5 acres or less and this site is less than 1 acre.
- The required head for the above design will be 3.5 feet, including ponding depth (9 inches), mulch (3 inches), filter media (18 inches), choking layer (3 inches), and gravel layer (9 inches; see Figure 3.16). The outlet for the underdrain must be at least this deep.
- The water table must be at least 2 feet below the underdrain, or 5.5 feet below the surface. According to the Soil Survey, Beltsville soils have a 1.5- to 2-foot depth to groundwater table, Croom soils have greater than a 5-foot depth, and Sassafra soils have a 4-foot depth. On-site soil investigations will be needed to determine if the 5.5-foot depth to the groundwater table can be met on this site.
- Due to soil contamination and the bioretention area's proximity to the building (less than 10 feet), an impermeable liner is required.

Since all of these assumptions and requirements can be met in this design example (pending groundwater table investigations), this step is complete.

**Step 7: Use the Adjusted Curve Number to Address Peak Flow Requirements.**

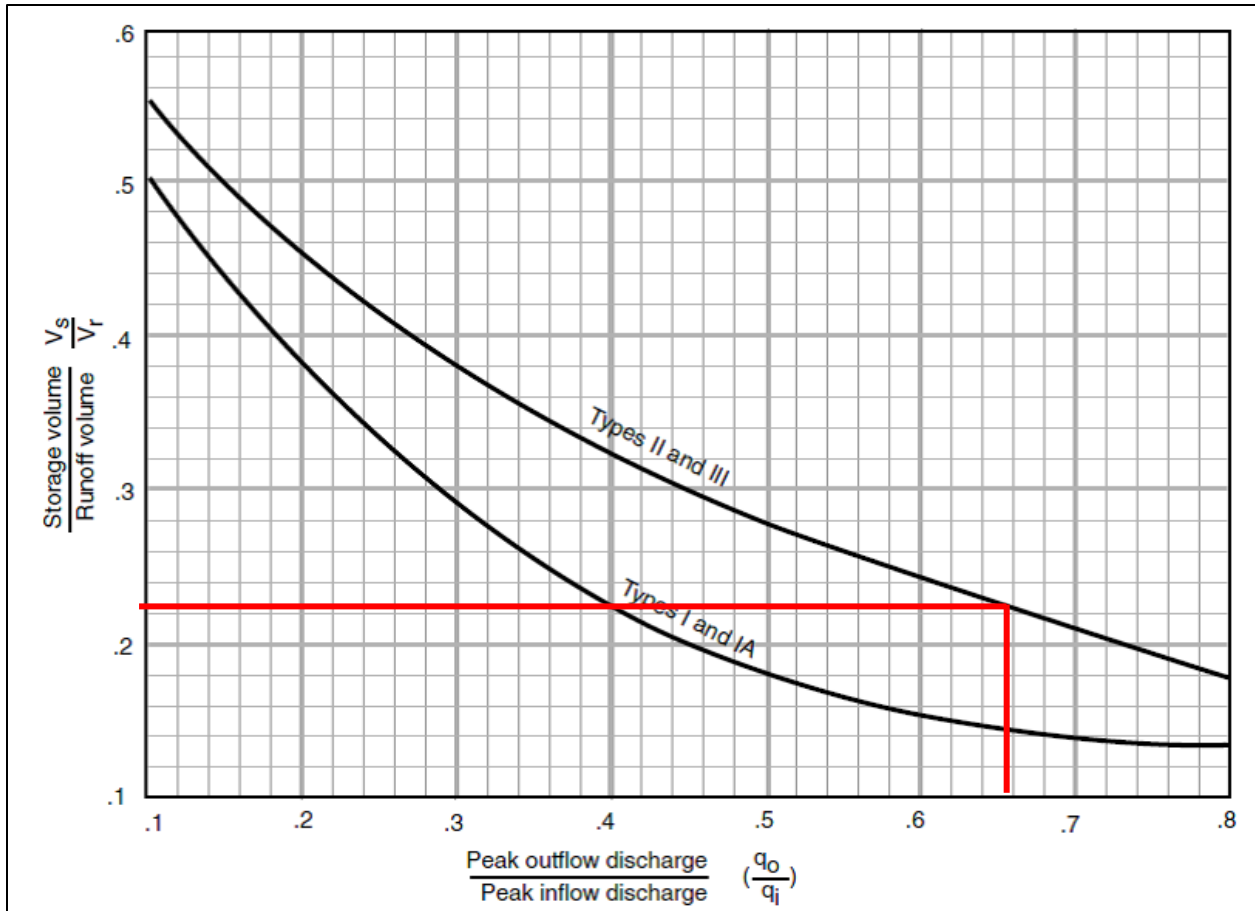
The original site CN of 92 is reduced for the 2-year, 15-year, and 100-year storms to 79, 82, and 83, respectively, by the storage provided by the cistern and bioretention cell. These values can be used to help determine detention requirements for this site.

**Step 8: Determine Detention Requirements.**

Detention is required to reduce the peak discharge rate from the 2-year storm event to the predevelopment (meadow conditions or better) peak discharge rate and to reduce the peak discharge rate from the 15-year storm event to the pre-project peak discharge rate. Appendix I - Acceptable Hydrologic Methods and Models includes details on how to calculate the detention volume. In this example, the proposed impervious cover and the proposed runoff CN are less than the pre-project conditions, so detention for the 15-year storm is not required. Detention for the 2-year storm will be required.

The peak inflow ( $q_{i2}$ ) and the peak outflow ( $q_{o2}$ ) can be calculated using the WinTR-55 Small Watershed Hydrology program, the area of the site, the time of concentration ( $T_c$ , assumed to be 10 minutes), and the CNs. The reduced CN of 79, determined above, generates a  $q_{i2}$  of 1.61 cubic feet per second (cfs). The CN for meadow in good condition, 71, generates a  $q_{o2}$  of 1.07 cfs.

The ratio of 1.07 cfs to 1.61 cfs equals 0.66. Using Figure H.1, the ratio of storage volume ( $V_{s2}$ ) to runoff volume ( $V_{r2}$ ) is 0.22.



**Figure A.1** Approximate detention basin routing for rainfall types I, IA, II and III.

The runoff with BMPs is 1.34 inches ( $Q_{BMP}$ ), which equates to 4,358 cubic feet ( $V_{r2}$ ). Using the calculated ratio of  $V_{s2}/V_{r2}$ , the storage volume required for the site ( $V_{s2}$ ) is 959 cubic feet.

With appropriate orifice design to ensure that outflows are properly restricted, this detention volume can be incorporated below the proposed bioretention area or located elsewhere on the site as a standalone detention practice.

## Design Example 2

### **Step 1: Determine Design Criteria.**

Design Example 2 includes the following proposed design criteria:

Site Name	Downtown Multi-Story Renovation
Total Site Area	15,000 ft <sup>2</sup>
Natural Cover Area	0 ft <sup>2</sup>
Compacted Cover	0 ft <sup>2</sup>
Impervious Cover (Rooftop)	15,000 ft <sup>2</sup>
Vehicular Access Areas	0 ft <sup>2</sup>
Is site located within the AWDZ?	No
Is site located within the MS4?	Yes
What type of activity is the site undergoing?	Major Substantial Improvement

### **Step 2: Input Design Criteria to Determine the Retention and Treatment Requirements.**

Based on the design criteria above, the Multi-Story Renovation project is required to treat 0.8 inches of rainfall for the SWRv:

$$SWRv = 950 \text{ ft}^3$$

### **Step 3: Identify Site Constraints and BMP Restrictions.**

Key considerations for the Multi-Story Renovation project include the following:

- Since this is a rooftop-only site, very few treatment options are available.
- As a renovation, the structure of the existing roof will be a factor for any rooftop practice.

### **Step 4: Select BMPs to Meet the Retention and Treatment Requirements.**

As an initial estimate, 75% of the rooftop is proposed to be converted to a green roof, with the remaining 25% draining to it. Therefore, the land use values need to be changed to account for the green roof: 3,750 square feet as impervious cover and 11,250 square feet as BMP. There will be only one SDA for the site. The goal of this design is to capture the entire retention volume (950 ft<sup>3</sup>) in the green roof.

### **Step 5: Size the BMPs According to the Design Equations.**

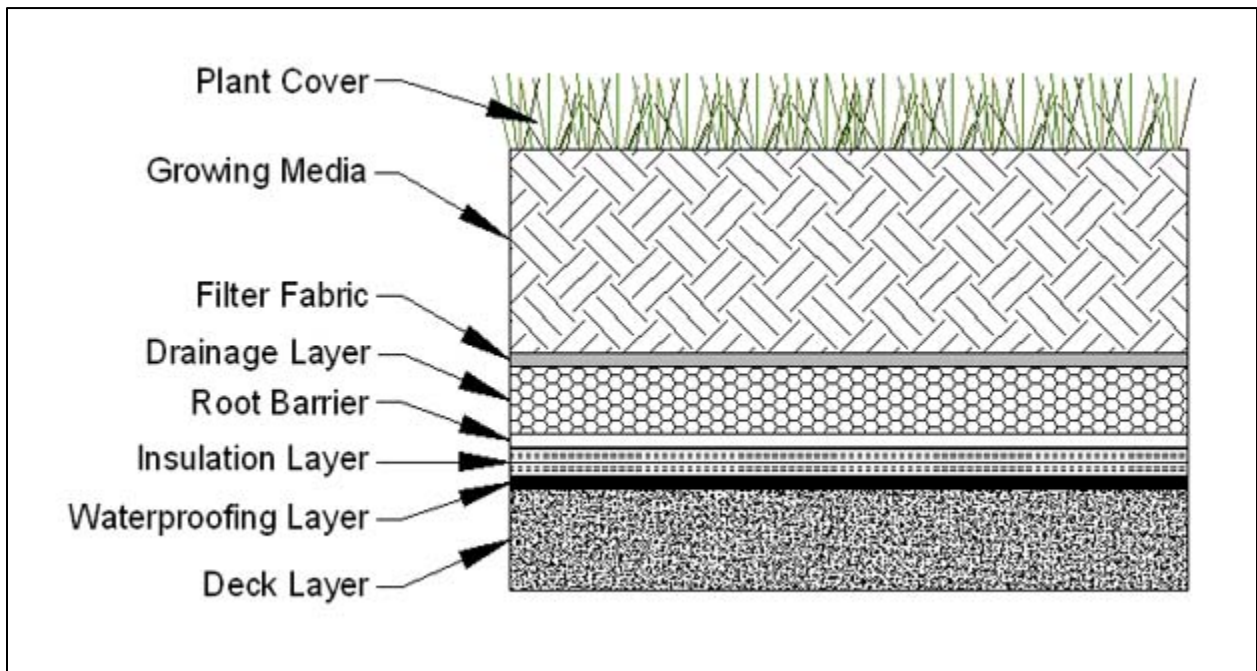
The green roof needs to be sized according to Equation 3.1. Since green roofs are typically manufactured systems, several of the parameters, such as the drainage layer depth and maximum water retention of all layers, need to be provided by the manufacturer. The values for the roof used in this design are provided in the variable descriptions below Equation 3.1 (with each layer illustrated in Figure 3.1).

**Equation 3.1 Storage Volume for Green Roofs**

$$Sv = \frac{SA \times [(d \times MWR_1) + (DL \times MWR)]}{12}$$

where:

- $Sv$  = storage volume (ft<sup>3</sup>) (goal is 950 ft<sup>3</sup>)
- $SA$  = green roof area (ft<sup>2</sup>) (need to determine)
- $d$  = media depth (in.) (6 in.)
- $MWR_1$  = verified media maximum water retention (0.25)
- $DL$  = drainage layer depth (in.) (1 in.)
- $MWR_2$  = verified drainage layer maximum water retention (0.4)



**Figure 3.1 Typical layers for a green roof.**

Rearranging Equation 3.1 finds the minimum required surface area:

$$SA = \frac{Sv \times 12}{[(d \times MWR_1) + (DL \times MWR_2)]}$$

or:

$$SA = \frac{950}{[(6 \times 0.25) + (1 \times 0.4)] \times 12} = 6,000 \text{ ft}^2$$

Therefore, the green roof must be sized to be at least 6,000 square feet, given the proposed depths. The original assumption was that an 11,250-square-foot roof would be used. Since a smaller roof is feasible, the drainage areas in the spreadsheet may be revised accordingly.

Note: If the CDA to the green roof is increased beyond the area of the green roof itself, design details will need to be provided that show how runoff from the additional CDA will be sufficiently distributed over the green roof. The absolute maximum CDA to the green roof shall be no more than 100% larger than the area of the green roof. Alternatively, a larger green roof may be utilized, and the increased storage volume can be used to reduce peak flow volume requirements (see Step 8) or sold as SRCs.

**Step 6: Check Design Assumptions and Requirements.**

Key assumptions and requirements for this site include the following:

- A structural analysis of the building is needed to determine that the green roof can be supported by the existing structure.
- Ensure that there is sufficient space on the rooftop (allowing for structures such as vents, steep areas of the roof, and other panels). In this case, the minimum roof area of 6,000 square feet is less than half of the entire roof area, and most roofs can accommodate this area.
- At least 1,500 square feet of the rooftop not covered by green roof needs to be designed so that it drains to the green roof without damaging it.

Since all of these assumptions and requirements can be met in this design example, this step is complete.

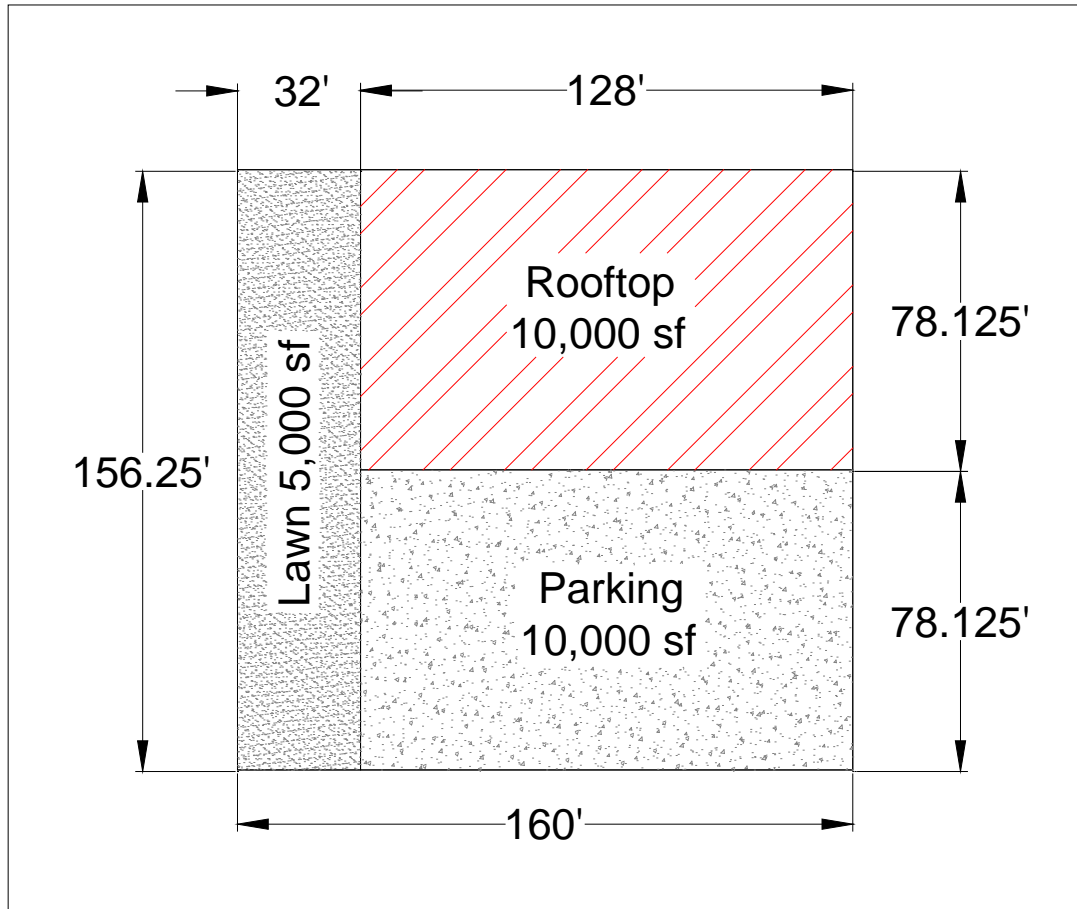
**Design Example 3**

**Step 1: Determine Design Criteria.**

Design Example 3 includes the following proposed design criteria:

Site Name	Ward 5 Low-Rise Commercial
Total Site Area	25,000 ft <sup>2</sup>
Natural Cover Area	0 ft <sup>2</sup>
Compacted Cover	5,000 ft <sup>2</sup>
Impervious Cover	20,000 ft <sup>2</sup>
Vehicular Access Areas	10,000 ft <sup>2</sup>
Is site located in the AWDZ?	No
Is site located within the MS4?	Yes
What type of activity is site undergoing?	Major Land-Disturbing





**Step 2: Input Design Criteria to Determine the Retention and Treatment Requirements.**

Based on the design criteria above, the project has the following requirement:

$$SWRv = 2,025 \text{ ft}^3$$

**Step 3: Identify Site Constraints and BMP Restrictions.**

Key considerations for the project include the following:

- Only a small portion of the compacted cover is available for potential BMPs.
- The Multi-Family Residential site is not restrictive of BMP options.
- The relatively permeable Sunnyside-Sassafras-Muirkirk-Christiana soils on this site allow for infiltration into site soils.

**Step 4: Select BMPs to Meet the Retention and Treatment Requirements.**

An enhanced bioretention with no underdrain is chosen for this site, primarily to minimize cost. Several other options, such as permeable pavers, would have been acceptable at this site.

The site will ultimately have one outlet point, with only one BMP, so there is only one SDA.

It is assumed that the entire site will be directed to the bioretention area. However, the surface area of the bioretention area must be accounted for. It was determined that only 1,000 square feet of compacted cover would be available for a bioretention area. Compacted cover will now be 4,000 square feet, and BMP area will be 1,000 square feet. The rooftop and parking areas will not change. This approach will lead to a total volume of 2,968 cubic feet directed to the BMP.

Since enhanced bioretention receives 100% retention value, the required storage volume to meet the SWRV is 2,095 cubic feet. This is the required SWRV after changes in land use were made to account for the bioretention surface area. However, the 1,000 square feet available will not be sufficient to provide the entire required storage volume. Through trial and error (see Step 5 below) it was determined that the maximum storage volume is 1,301 cubic feet. While this stormwater management plan achieves at least 50% on-site retention, it does not achieve 100%; there is still 794 cubic feet, or 5,939 gallons remaining. This volume will have to be met through the purchase or generation of SRCs (see Chapter 7, “Generation, Certification, Trading, and Retirement of Stormwater Retention Credits” and Step 9 below).

**Step 5: Size the BMPs According to the Design Equations.**

Assume a filter media depth of 2 feet, a gravel depth of 0.75 feet, and a ponding depth of 1 foot.

**Step 5.1: Check the Filter Media Depth.**

Ensure that the filter media depth does not exceed the maximum in Table 3.20. The ratio of the surface area of the bioretention (1,000 ft<sup>2</sup>) to the CDA (25,000 ft<sup>2</sup>) is 4%. The Rv was previously determined to be 0.84. The maximum filter media depth allowed is 4.0 feet. As the bioretention was sized with 2 feet of filter media, it passes this check.

**Table 3.20 Determining Maximum Filter Media Depth (feet)**

SA:CDA (%)	Rv <sub>CDA</sub>								
	0.25	0.3	0.40	0.50	0.60	0.70	0.80	0.90	0.95
0.5	6.5	6.5	6.5	6.5	6.5	6.5	6.5	6.5	6.5
1.0	5.0	5.5	6.0	6.5	6.5	6.5	6.5	6.5	6.5
1.5	3.5	4.0	5.0	6.0	6.0	6.5	6.5	6.5	6.5
2.0		3.0	4.0	4.5	5.5	6.0	6.0	6.5	6.5
2.5			3.5	4.0	4.5	5.0	5.5	6.0	6.0
3.0				3.5	4.0	4.5	5.0	5.5	5.5
3.5					3.5	4.0	4.5	5.0	5.0
4.0					3.0	3.5	4.0	4.5	4.5
4.5						3.5	3.5	4.0	4.0
5.0							3.5	4.0	4.0
5.5								3.5	3.5
6.0								3.0	3.5
6.5									3.0
7.0+									

**Step 5.2: Determine the Storage Volume.**

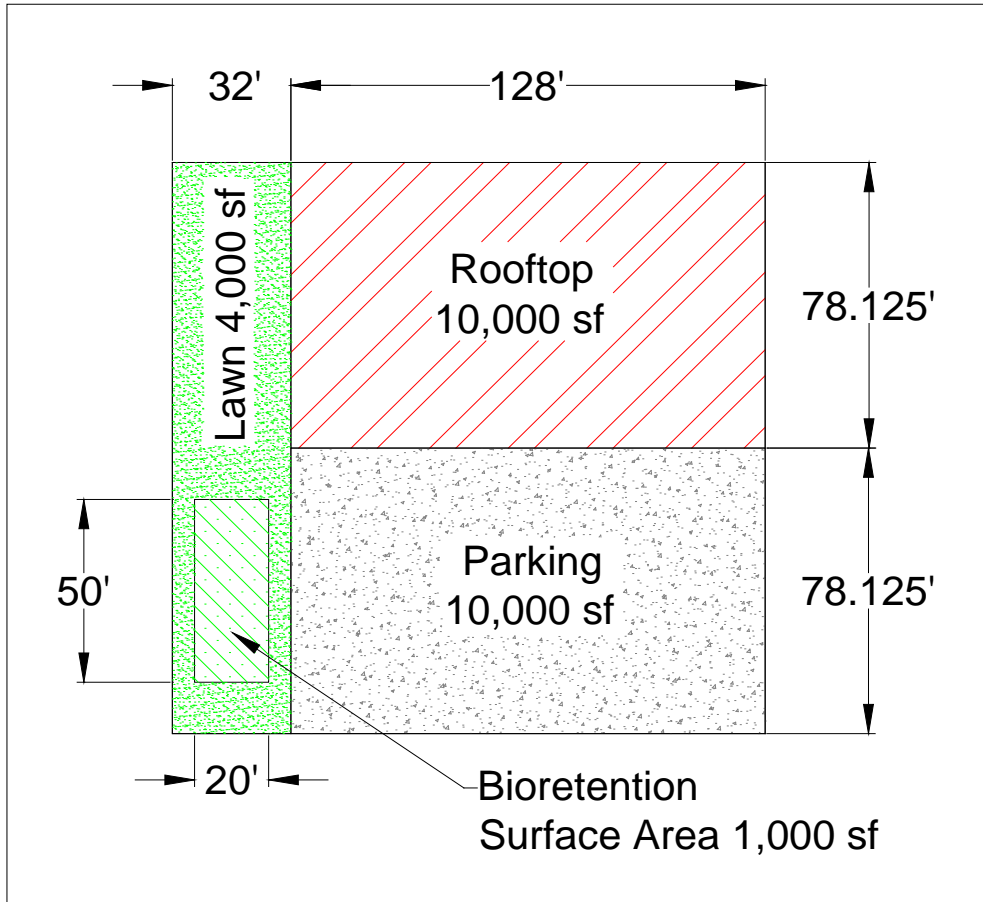
**Equation 3.5**

$$Sv = SA_{bottom} \times [(d_{media} \times \eta_{media}) + (d_{gravel} \times \eta_{gravel})] + (SA_{average} \times d_{ponding})$$

where:

$Sv$	=	total storage volume of bioretention (ft <sup>3</sup> )
$SA_{bottom}$	=	bottom surface area of bioretention (ft <sup>2</sup> )
$d_{media}$	=	depth of the filter media, including mulch layer (ft)
$\eta_{media}$	=	effective porosity of the filter media (typically 0.25)
$d_{gravel}$	=	depth of the underdrain and underground storage gravel layer, including choker stone (ft)
$\eta_{gravel}$	=	effective porosity of the gravel layer (typically 0.4)
$SA_{average}$	=	average surface area of the bioretention (ft <sup>2</sup> ) typically, where $SA_{top}$ is the top surface area of bioretention, $SA_{average} = \frac{SA_{bottom} + SA_{top}}{2}$
$d_{ponding}$	=	maximum ponding depth of the bioretention (ft)

Solving Equation 3.5 often requires an iterative approach to determine the most appropriate bottom surface area and average surface area to achieve the desired Sv. In this case, a long, narrow practice with a 50- by 20-foot top area and 3H:1V side slopes was all that would fit on the site. This configuration will provide an  $SA_{top}$  of 1,000 square feet, an  $SA_{bottom}$  of 616 square feet, an  $SA_{average}$  of 808 square feet, and will achieve an Sv of 1,301 cubic feet.



**Step 6: Check Design Assumptions and Requirements.**

Key assumptions and requirements for this site include the following:

- The design will need at least 1,000 square feet of surface area. The designer would need to ensure that this area is available.
- The CDA for traditional bioretention must be 2.5 acres or less, and this site has a total drainage area of less than 0.5 acres.
- Vehicular access areas must be addressed. The vehicular access retention/treatment requirement of 475 cubic feet is met by this design.
- Head requirements are not likely to be an issue since this is an infiltration design.
- The water table must be at least 2 feet below the bottom of the bioretention, or 4.25 feet below the surface.
- In order to infiltrate the 1,301-cubic-foot storage volume, the saturated hydraulic conductivity must be at least 0.36 inches per hour.
- Additional SRCs will need to be generated or purchased off-site.

Since all of these assumptions and requirements can be met (pending groundwater table and infiltration rate investigations) in this design example, this step is complete.

**Step 7: Use the Adjusted Curve Number to Address Peak Flow Requirements.**

The original site CN of 92 is reduced for the 2-year, 15-year, and 100-year storms to 85, 86, and 87, respectively, by the retention provided by the bioretention cell. These CNs can be used to help determine detention requirements for this site.

**Step 8: Determine the Detention Requirements.**

Detention is required to reduce the peak discharge rate from the 2-year storm event to the predevelopment (meadow conditions or better) peak discharge rate and to reduce the peak discharge rate from the 15-year storm event to the pre-project peak discharge rate. Appendix I - Acceptable Hydrologic Methods and Models includes details on how to calculate the detention volume. In this example, the proposed impervious cover and the proposed runoff CN is less than the pre-project conditions, so detention for the 15-year storm is not required. Detention for the 2-year storm will be required.

The peak inflow ( $q_{i2}$ ) and the peak outflow ( $q_{o2}$ ) can be calculated using the WinTR-55 Small Watershed Hydrology program, the area of the site, the time of concentration ( $T_c$ , assumed to be 10 minutes), and the CNs. The reduced CN of 87, determined above, generates a  $q_{i2}$  of 1.85 cfs. The CN for meadow in good condition, 58, generates a  $q_{o2}$  of 0.18 cfs.

The ratio of 0.18 cfs to 1.85 cfs equals 0.10. Using Figure H.1, the ratio of storage volume ( $V_{s2}$ ) to runoff volume ( $V_{r2}$ ) is 0.55.

The runoff with BMPs is 1.73 inches ( $Q_{BMP}$ ), which equates to 3,604 cubic feet ( $V_{r2}$ ). Using the calculated ratio of  $V_{s2}/V_{r2}$ , the storage volume required for the site ( $V_{s2}$ ) is 1,982 cubic feet.

This detention volume, with appropriate orifice design to ensure that outflows are properly restricted, can be incorporated below the proposed bioretention area or located elsewhere on the site, such as underneath the parking lot as a standalone detention practice.

**Step 9: Identify Stormwater Retention Credits.**

Since the SWR<sub>v</sub> was short of the requirement by 5,939 gallons, 5,939 SRCs will need to be purchased or generated annually for this site to achieve compliance (see Chapter 7, “Generation, Certification, Trading, and Retirement of Stormwater Retention Credits” for more details and example calculations).

**Design Example 4**

Design Example 4 includes the following proposed design criteria:

Site Name	Green St. and Gold St. Intersection
Total Site Area	13,528 ft <sup>2</sup>
Natural Cover Area	0 ft <sup>2</sup>
Compacted Cover	185 ft <sup>2</sup>
Impervious Cover	13,343 ft <sup>2</sup>

The site in this design example is a street reconstruction project. Since it is located in the PROW, the MEP design process applies (see Appendix B - Maximum Extent Practicable Process for Existing Public Right-of-Way).

**Step 1: Calculate SWR<sub>v</sub>.**

This intersection includes four stormwater inlets (one at each corner), so it will be divided into four SDAs. The DDOT Maximum Extent Practicable Design Worksheet requires calculation of the CDA within the limits of disturbance (LOD) as well as calculation of the CDA outside the LOD.

Site Drainage Area (SDA 1 - N)	CDA (ft <sup>2</sup> )		SWR <sub>v</sub> (gal)	
	within LOD	outside LOD	within LOD	outside LOD
SDA 1	3,473	1,138	2,371	809
SDA 2	2,937	987	2,087	701
SDA 3	5,285	1,747	3,756	1,241
SDA 4	1,833	1,931	1,303	1,372
<b>SDA TOTAL</b>	<b>13,528</b>	<b>5,803</b>	<b>9,517</b>	<b>4,123</b>

All of the drainage areas were 100% impervious, except for SDA 1, which included 185 square feet of landscaped area within the LOD.

**Step 2: Consider Infiltration.**

This step requires looking at infiltration options by identifying constraints to infiltration, such as a high water table, soil contamination, or poor infiltration rates, and locating areas that are well suited for infiltration.

In this example, a high water table and soil contamination were not a concern. The soil had only a moderate to low infiltration rate, making an infiltration sump a possibility as part of another BMP (such as enhanced bioretention) but not feasible as a standalone BMP.

**Step 3: Demonstrate Full Consideration of Land-Cover Conversions and Optimum BMP Placement.**

Opportunities for BMP placement within and adjacent to the PROW include traffic islands, triangle parks, cul-de-sacs, paper streets, and traffic calming measures, such as median islands, pedestrian curb extensions, bump outs, chicanes, and turning radius reductions.

As this example is a small intersection project, pedestrian curb extensions are the only feasible location for BMP placement. BMP locations in the pedestrian curb extensions will be possible at three of the four corners of the intersection.

**Step 4: Demonstrate Full Consideration of Opportunities Within Existing Infrastructure.**

This step requires the assessment and documentation of utility locations, storm sewer depths, right-of-way widths, and existing trees to determine potential conflicts.

In this example, the difference in elevation between the storm sewer inlets and the invert of the pipes is approximately 5 feet. Other utilities will constrain the space available for the proposed BMPs but will not eliminate the pedestrian curb extension spaces entirely.

**Step 5: Locate and Choose BMPs.**

Although they may be undersized, enhanced bioretention areas will be selected for 3 of the 4 corners in the space available.

Areas for enhanced bioretention are as follows:

Site Drainage Area (SDA 1 - N)	CDA within LOD (ft <sup>2</sup> )	SWRv within LOD (gal)	Available Area for BMP (ft <sup>2</sup> )
SDA 1	3,473	2,371	72
SDA 2	2,937	2,087	285
SDA 3	5,285	3,756	190
SDA 4	1,833	1,303	0
<b>SDA TOTAL</b>	<b>13,528</b>	<b>9,517</b>	<b>N/A</b>

**Step 6: Size BMPs.**

Each bioretention area will be designed with a similar cross section: vertical side slopes for the ponding area, a ponding depth of 0.75 feet, a filter media depth of 2 feet, and a gravel depth (including the infiltration sump) of 1.25 feet.

The storage volume is determined with Equation 3.5

**Equation 3.5**

$$Sv = SA_{bottom} \times [(d_{media} \times \eta_{media}) + (d_{gravel} \times \eta_{gravel})] + (SA_{average} \times d_{ponding})$$

where:

- $Sv$  = total storage volume of bioretention (ft<sup>3</sup>)
- $SA_{bottom}$  = bottom surface area of bioretention (ft<sup>2</sup>)
- $d_{media}$  = depth of the filter media, including mulch layer (ft)
- $\eta_{media}$  = effective porosity of the filter media (typically 0.25)
- $d_{gravel}$  = depth of the underdrain and underground storage gravel layer, including choker stone (ft)

## Appendix A Compliance Calculations and Design Examples

$$\eta_{\text{gravel}} = \text{effective porosity of the gravel layer (typically 0.4)}$$

$$SA_{\text{average}} = \text{average surface area of the bioretention (ft}^2\text{) typically, where } SA_{\text{top}} \text{ is the top surface area of bioretention,}$$

$$SA_{\text{average}} = \frac{SA_{\text{bottom}} + SA_{\text{top}}}{2}$$

$$d_{\text{ponding}} = \text{maximum ponding depth of the bioretention (ft)}$$

With the cross-section dimensions provided above, Equation 3.5 yields the following results:

Site Drainage Area (SDA 1 - N)	Available Area for BMP (ft <sup>2</sup> )	Sv (gal)	Sv (ft <sup>3</sup> )
SDA 1	72	942	126
SDA 2	285	3,731	499
SDA 3	190	2,487	332
SDA 4	0	0	0

The table below indicates there is a retention deficiency for the 3 SDAs that contain proposed BMPs.

Site Drainage Area (SDA 1 - N)	Regulated SWRv within LOD (gal)	SWRv Achieved (gal)	Retention Deficiency (gal)	Altered Drainage Profile (Y/N)
SDA 1	2,371	942	1,429	N
SDA 2	2,087	3,731	N/A	N
SDA 3	3,756	2,487	1,269	N
SDA 4	1,303	-	1,303	X
<b>SDA TOTAL</b>	<b>9,517</b>	<b>7,160</b>		

If there is a retention volume deficiency, the MEP design process notes that the designer should consider sizing BMPs to manage the comingled volume on site, and/or revisit Design Steps 1–6 to increase land conversion areas and BMP facilities.

In this case, the proposed bioretention areas in SDA 2 could treat additional volume, but the proposed bioretention areas in SDA 1 and SDA 3 are at capacity. At this point, the designer should review Steps 1 through 6 to ensure that all opportunities for land conversion and BMP facilities have been maximized. If so, this step is complete.

### **Step 7: Identify Drainage Areas Where Zero-Retention BMPs are Installed.**

Drainage areas that do not include retention BMPs will require installation of a water quality catch basin to treat stormwater runoff. This requirement applies only to SDA 4 in this example.



**Design Example 5**

**Step 1: Determine Design Criteria.**

Design Example 5 includes the following proposed design criteria:

Site Name	NoMa Office Tower
Total Site Area	65,340 ft <sup>2</sup>
Natural Cover Area	0 ft <sup>2</sup>
Compacted Cover	0 ft <sup>2</sup>
Impervious Cover (Rooftop)	65,340 ft <sup>2</sup>
Vehicular Access Areas	0 ft <sup>2</sup>
Is site located within the AWDZ?	No
Is site located within the MS4?	Yes
What type of activity is the site undergoing?	Major Land-Disturbing

**Step 2: Input Design Criteria to Determine the Retention and Treatment Requirements.**

Based on the design criteria above, the NoMa Office Tower project is required to treat 1.2 inches of rainfall for the SWRv:

$$SWRv = 6,207 \text{ ft}^3$$

**Step 3: Identify Site Constraints and BMP Restrictions.**

The key consideration for the NoMa Office tower project is limited space. Construction from lot line to lot line means there are limited retention and treatment options. A rooftop approach is selected.

**Step 4: Select BMPs to Meet the Retention and Treatment Requirements.**

As an initial estimate, 60% of the rooftop is proposed to be converted to a green roof, with an additional 15% of the remaining rooftop draining to it. Therefore, the land use values need to be changed to account for the green roof: 26,136 square feet should be counted as impervious area for the rooftop, and 39,204 square feet should be counted as BMP. There will be only one SDA. For the green roof CDA, 9,801 square feet should be counted as impervious cover, and 39,204 should be counted as BMP surface area. The goal of this design is to capture the entire retention volume (6,207 ft<sup>3</sup>) in the green roof.

**Step 5: Size the BMPs According to the Design Equations.**

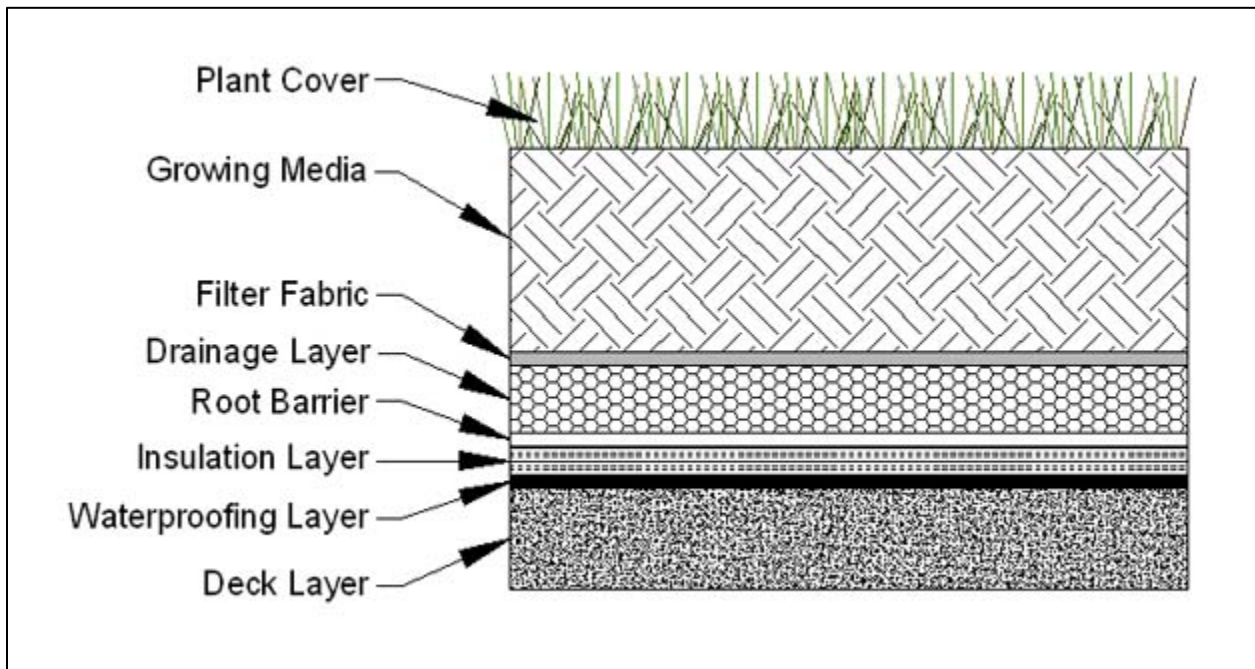
The green roof needs to be sized according to Equation 3.1. Note that, since green roofs are typically manufactured systems, several of the parameters, such as the drainage layer depth and maximum water retention of all layers, need to be provided by the manufacturer. In this example, a media depth of 6 inches with maximum water retention of 0.40 was chosen. The drainage layer has a depth of 1 inch and maximum water retention of 0.15. These values are indicated in the variable descriptions below Equation 3.1 (with each layer illustrated in Figure 3.1).

**Equation 3.1 Storage Volume for Green Roofs**

$$Sv = \frac{SA \times [(d \times MWR_1) + (DL \times MWR_2)]}{12}$$

where:

- $Sv$  = storage volume (ft<sup>3</sup>)
- $SA$  = green roof area (ft<sup>2</sup>)
- $d$  = media depth (in.) (minimum 3 in.)
- $MWR_1$  = verified media maximum water retention
- $DL$  = drainage layer depth (in.)
- $MWR_2$  = verified drainage layer maximum water retention



**Figure 3.1 Typical layers for a green roof.**

Rearranging Equation 3.1 to find the minimum required surface area:

$$SA = \frac{Sv \times 12}{(d \times MWR_1) + (DL \times MWR_2)}$$

or:

$$SA = \frac{6,208 \times 12}{(6 \times 0.40) + (1 \times 0.15)} = 29,214 \text{ ft}^2$$

Therefore, the green roof must be sized to be at least 29,214 square feet (45% of the rooftop surface area), given the proposed depths. The original assumption was that a 39,204-square-foot roof would be used. Since a smaller roof is feasible, the drainage areas in the spreadsheet may be revised accordingly. If the larger green roof area is used, it could be designed with a lower media depth, or the increased storage volume could be used to reduce peak flow volume requirements (see Step 8) and/or sold as SRCs.

**Step 6: Check Design Assumptions and Requirements.**

Key assumptions and requirements for this site include:

- Ensure there is sufficient space on the rooftop (allowing for structures such as vents, steep areas of the roof, and other panels). In this case, the green roof area of 29,214 square feet is less than half of the entire roof area.
- At least 19,791 square feet of the rooftop not covered by green roof needs to be designed to drain to the green roof without damaging or overloading it. This may require level spreaders or other devices.

Since all of these assumptions and requirements can be met in this design example, this step is complete.

**Step 7: Use the Adjusted Curve Number to Address Peak Flow Requirements.**

The initial CN for this site is 98, but retention provided by the green roof changes this number. Adjusted Curve Numbers for the 2-year, 15-year, and 100-year storms are 86, 88, and 88, respectively. These CNs can be used to help determine detention requirements for this site.

**Step 8: Determine Detention Requirements.**

Detention is required to reduce the peak discharge rate from the 2-year-storm event to the predevelopment (meadow conditions or better) peak discharge rate and to reduce the peak discharge rate from the 15-year storm event to the pre-project peak discharge rate. Appendix I - Acceptable Hydrologic Methods and Models details the procedure to calculate the detention volume. In this example, the proposed land cover is the same as the pre-project conditions, so detention is not required for the 15-year storm. However, detention is required for the 2-year storm.

The peak inflow,  $qi_2$ , and the peak outflow,  $qo_2$ , can be calculated using the WinTR-55 Small Watershed Hydrology program, the area of the site, the time of concentration ( $T_c$ , assumed to be 10 minutes), and the CNs. The reduced CN of 86, determined above, generates a  $qi_2$  of 3.92 cfs. The CN for meadow in good condition, 71, generates a  $qo_2$  of 1.83 cfs.

The ratio of 1.83 cfs to 3.92 cfs equals 0.47. Using Figure H.1, this equates to a ratio of storage volume ( $V_{s2}$ ) to runoff volume ( $V_{r2}$ ) of approximately 0.29.

The runoff with BMPs is 1.83 inches ( $Q_{BMP}$ ), which equates to 9,964 cubic feet ( $V_{R2}$ ). Using the calculated ratio of  $V_{S2}/V_{R2}$ , the storage volume required for the site ( $V_{S2}$ ) is 2,890 cubic feet.

Rooftop Storage (see Appendix J - Rooftop Storage Design Guidance and Criteria) may be the most cost-effective method for achieving the detention volume in this example, if space is available and the design configuration can be created that routes the green roof to the rooftop storage. Alternatively, the required storage could be achieved via a tank located somewhere in the building.

### Design Example 6

#### **Step 1: Determine Design Criteria**

Design Example 6 includes the following proposed design criteria:

Site Name	Connecticut Ave. Complex
Total Site Area	65,340 ft <sup>2</sup>
Natural Cover Area	0 ft <sup>2</sup>
Compacted Cover	0 ft <sup>2</sup>
Impervious Cover (Rooftop)	65,340 ft <sup>2</sup>
Vehicular Access Areas	0 ft <sup>2</sup>
Is site located within the AWDZ?	No
Is site located within the MS4?	Yes
What type of activity is the site undergoing?	Major Land-Disturbing

#### **Step 2: Input Design Criteria to Determine the Retention and Treatment Requirements.**

Based on the design criteria above, the Connecticut Ave. Complex project is required to treat 1.2 inches of rainfall for the  $SWR_v$ :

$$SWR_v = 6,207 \text{ ft}^3$$

#### **Step 3: Identify Site Constraints and BMP Restrictions.**

The key consideration for the Connecticut Ave. Complex project is that since it is a rooftop-only site, very few treatment options are available.

#### **Step 4: Select BMPs to Meet the Retention and Treatment Requirements.**

Rainwater harvesting (R-1) is selected as the most appropriate BMP for this site.

The site will ultimately have one outlet point, and therefore one SDA.

The Rainwater Harvesting Retention Calculator should be used to determine the cistern size and the associated retention value. In the Rainwater Harvesting Retention Calculator, enter 65,340

square feet as the CDA. For utilization of the rainwater, flushing toilets/urinals is selected as the use, and the appropriate values are entered. In this case, 1,600 people will use the building per day, Monday through Friday, 8 hours per day. On the Storage Volume Results sheet, the storage volume values are given for various tank sizes. The table and graph show that an 80,000-gallon tank would have 6,823 cubic feet of storage.

The cistern will have a 65,340-square-foot CDA and a storage volume of 6,823 cubic feet, of which 100% is retained. The SWRv has been met for the site, and the exceedance of 4,605 gallons may be available to generate SRCs.

***Step 5: Size the BMPs According to the Design Equations.***

The size of the rainwater-harvesting cistern was already determined to be 80,000 gallons, although additional volume may be necessary for detention, as described in Step 8, as well as for dead storage for a pump, and/or freeboard.

***Step 6: Check Design Assumptions and Requirements.***

Key assumptions and requirements for this site include the following:

- The rainwater harvesting cistern will be at least 80,000 gallons. The designer would need to ensure that space would be available for these BMPs on the site.
- Demand for the water from toilet flushing should be verified.

Since all of these assumptions and requirements can be met in this design example, this step is complete.

***Step 7: Use the Adjusted Curve Number to Address Peak Flow Requirements.***

The initial CN for this site is 98, but retention provided by rainwater harvesting changes this number. The reduced CNs for the 2-year, 15-year, and 100-year storms are 84, 86, and 87, respectively. These CNs can be used to help determine detention requirements for this site.

***Step 8: Determine Detention Requirements.***

Detention is required to reduce the peak discharge rate from the 2-year-storm event to the predevelopment (meadow conditions or better) peak discharge rate and to reduce the peak discharge rate from the 15-year storm event to the pre-project peak discharge rate. Appendix I - Acceptable Hydrologic Methods and Models details the procedure to calculate the detention volume. In this example, the proposed land cover is the same as the pre-project conditions, so detention is not required for the 15-year storm. However, detention is required for the 2-year storm.

The peak inflow ( $q_{i2}$ ) and the peak outflow ( $q_{o2}$ ) can be calculated using the WinTR-55 Small Watershed Hydrology program, the area of the site, the time of concentration ( $T_c$ , assumed to be 10 minutes), and the CNs. The reduced CN of 84, determined above, generates a  $q_{i2}$  of 3.61 cfs. The CN for meadow in good condition, 71, generates a  $q_{o2}$  of 1.74 cfs.

The ratio of 1.74 cfs to 3.61 cfs equals 0.48. Using Appendix I - - Acceptable Hydrologic Methods and Models, this equates to a ratio of storage volume ( $V_{S2}$ ) to runoff volume ( $V_{R2}$ ) of approximately 0.29.

The runoff with BMPs is 1.71 inches ( $Q_{BMP}$ ), which equates to 9,295 cubic feet ( $V_{R2}$ ). Using the calculated ratio of  $V_{S2}/V_{R2}$ , the storage volume required for the site ( $V_{S2}$ ) is 2,696 cubic feet.

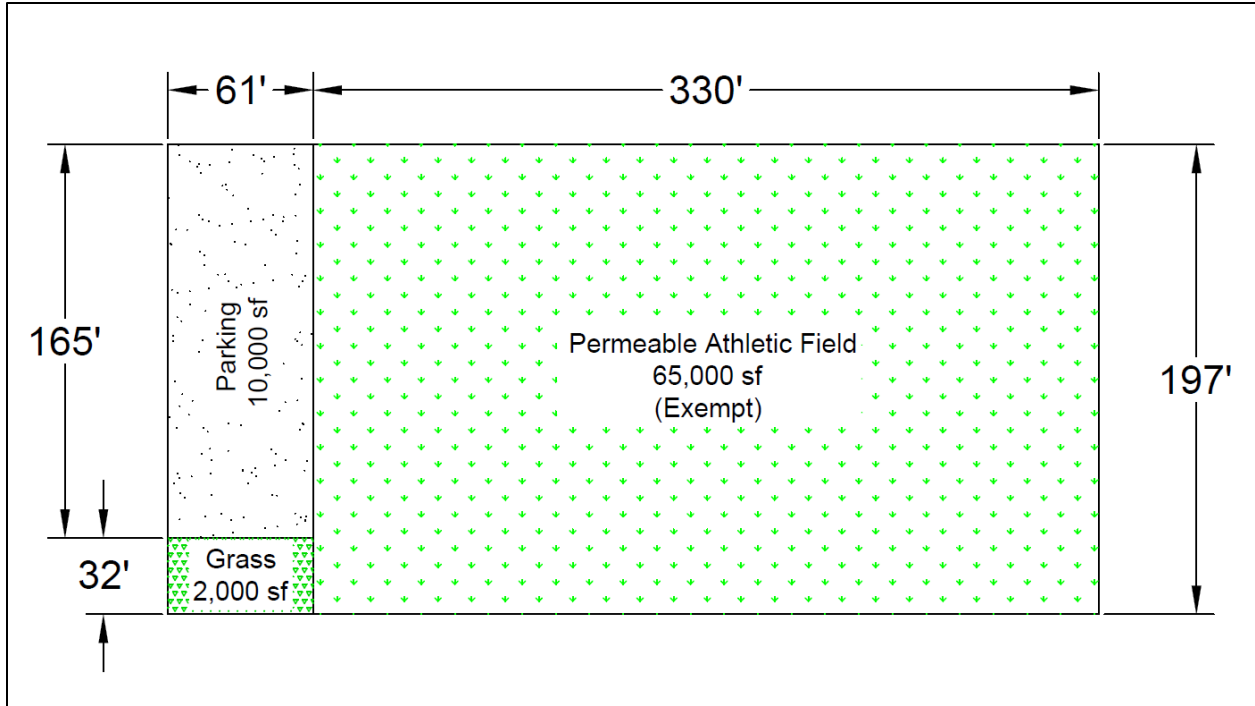
Since rainwater harvesting is the selected BMP on this project, the most appropriate means for detaining the 2,696 cubic feet (20,163 gallons) may be to increase the size of the cistern to 13,500 cubic feet (101,000 gallons). Alternatively, if stage-storage routing is performed on the tank for a 2-year storm event, beginning with the average daily volume in the tank, the detention volume may be decreased significantly.

**Design Example 7**

**Step 1: Determine Design Criteria**

Design Example 7 includes the following proposed design criteria:

Site Name	Anacostia School
Total Site Area	77,000 ft <sup>2</sup>
Natural Cover Area	0 ft <sup>2</sup>
Compacted Cover	2,000 ft <sup>2</sup>
Impervious Cover	10,000 ft <sup>2</sup>
Vehicular Access Areas	0 ft <sup>2</sup>
Exempt Areas	65,000 ft <sup>2</sup>
Is site located within the AWDZ?	No
Is site located within the MS4?	No
What type of activity is the site undergoing?	Major Land-Disturbing



**Step 2: Input Design Criteria to Determine the Retention and Treatment Requirements.**

Because a portion of the site is exempt from stormwater management requirements, only the impervious cover and compacted cover areas are counted towards calculating the  $SWR_v$  for the project. Based on the design criteria above, Anacostia School has the following requirements:

$$SWR_v = 1,000 \text{ ft}^3$$

**Step 3: Identify Site Constraints and BMP Restrictions.**

Key considerations for Anacostia School include the following:

- Because the permeable athletic field is publically accessible at the school, the athletic field area is exempt from stormwater management requirements.
- The site has poor infiltration rates, so underdrains will be required for any BMPs.

**Step 4: Select BMPs to Meet the Retention and Treatment Requirements.**

While there are numerous options for stormwater management of this site, a traditional bioretention (B-1) was selected. Since the site has poor infiltration, an underdrain is required and the enhanced bioretention option is not available.

The site will ultimately have one outlet point and therefore one SDA.

The bioretention area will receive runoff from the impervious area of the site. Through trial and error, it was determined that a 1,000-square-foot bioretention area would be sufficient to meet the retention requirement. This area will be taken from the compacted cover area. Compacted cover will now be 1,000 square feet, and BMP will be 1,000 square feet. Impervious cover

directed to the bioretention area will be 10,000 square feet. There will also be 1,000 square feet of compacted cover and 1,000 square feet of BMP surface area directed to the bioretention area. Because the site is in the CSS, there is no need to consider vehicular access areas.

The total volume directed to the bioretention area will be 1,516 cubic feet. A bioretention storage volume of 1,900 cubic feet would lead to an exceedance of 524 gallons for the SWRv.

**Step 5: Size the BMPs According to the Design Equations.**

To meet the bioretention criteria, the bioretention area is sized with 3 feet of filter media, 1 foot of gravel, and a 0.75-foot ponding depth. The bioretention cell sizing goal is 1,900 cubic feet.

**Step 5.1: Check the Filter Media Depth.**

Ensure that the filter media depth does not exceed the maximum in Table 3.20. The ratio of the surface area of the BMP (1,000 square feet) to the CDA (12,000 square feet) is 8.3%. The Rv for the CDA to the bioretention practice is 0.89. There is no maximum filter media depth with this design.

**Table 3.20 Determining Maximum Filter Media Depth (feet)**

SA:CDA (%)	R <sub>V</sub> CDA								
	0.25	0.3	0.40	0.50	0.60	0.70	0.80	0.90	0.95
0.5	6.5	6.5	6.5	6.5	6.5	6.5	6.5	6.5	6.5
1.0	5.0	5.5	6.0	6.5	6.5	6.5	6.5	6.5	6.5
1.5	3.5	4.0	5.0	6.0	6.0	6.5	6.5	6.5	6.5
2.0		3.0	4.0	4.5	5.5	6.0	6.0	6.5	6.5
2.5			3.5	4.0	4.5	5.0	5.5	6.0	6.0
3.0				3.5	4.0	4.5	5.0	5.5	5.5
3.5				3.0	3.5	4.0	4.5	5.0	5.0
4.0					3.0	3.5	4.0	4.5	4.5
4.5						3.5	3.5	4.0	4.0
5.0							3.5	4.0	4.0
5.5								3.5	3.5
6.0								3.0	3.5
6.5									3.0
7.0+									

**Step 5.2: Determine Storage Volume.**

**Equation 3.5**

$$Sv = SA_{bottom} \times [(d_{media} \times \eta_{media}) + (d_{gravel} \times \eta_{gravel})] + (SA_{average} \times d_{ponding})$$

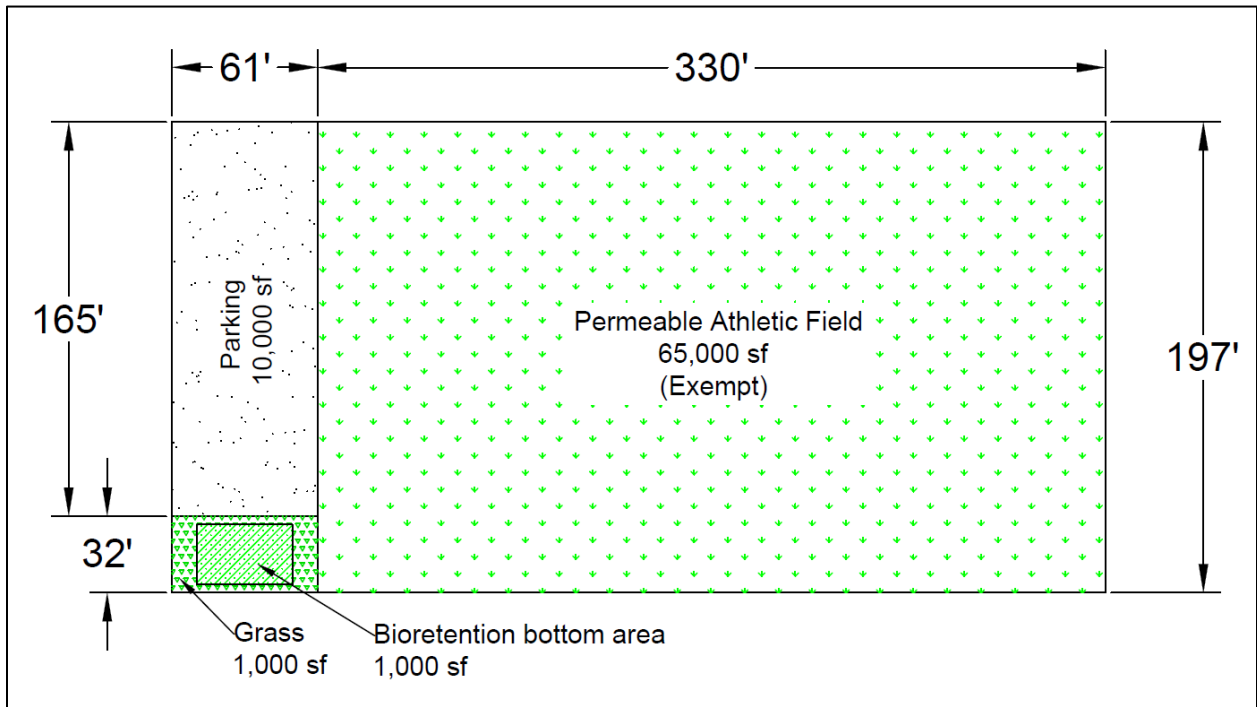
where:



- $S_v$  = total storage volume of bioretention (ft<sup>3</sup>)
- $SA_{bottom}$  = bottom surface area of bioretention (ft<sup>2</sup>)
- $d_{media}$  = depth of the filter media, including mulch layer (ft)
- $\eta_{media}$  = effective porosity of the filter media (typically 0.25)
- $d_{gravel}$  = depth of the underdrain and underground storage gravel layer, including choker stone (ft)
- $\eta_{gravel}$  = effective porosity of the gravel layer (typically 0.4)
- $SA_{average}$  = average surface area of the bioretention (ft<sup>2</sup>)  
typically, where  $SA_{top}$  is the top surface area of bioretention,  

$$SA_{average} = \frac{SA_{bottom} + SA_{top}}{2}$$
- $d_{ponding}$  = maximum ponding depth of the bioretention (ft)

Solving Equation 3.5 often requires an iterative approach to determine the most appropriate bottom surface area and average surface area to achieve the desired  $S_v$ . In this case, a bioretention with a 40-foot by 25-foot top area and 3H:1V side slopes will provide an  $SA_{top}$  of 1,312.5 square feet, an  $SA_{bottom}$  of 1,000 square feet, an  $SA_{average}$  of 1,156 square feet, and achieve an  $S_v$  of 2,306 cubic feet. This more than meets the goal of 1,900 cubic feet. If desired, the surface area of the practice could be reduced accordingly, or more SRCs could be generated with the excess volume.



**Step 6: Check Design Assumptions and Requirements.**

Key assumptions and requirements for this site include the following:

- Based upon the above design the bioretention cell will require at least 1,000 square feet of surface area. The designer would need to ensure that space would be available for the bioretention.
- The CDA for traditional bioretention must be 2.5 acres or less and this site is less than 1 acre.
- The required head for the above design will be 4.75 feet, including ponding depth (9 inches), mulch (3 inches), filter media (33 inches), choking layer (about 3 inches), and gravel layer (9 inches). The outlet for the underdrain must be at least this deep.
- The water table must be at least 2 feet below the underdrain, or 6.75 feet below the surface. According to the Soil Survey, Croom soils have greater than a 5-foot depth. On-site soil investigations will be needed to determine if the 6.75-foot depth to the groundwater table can be met on this site.

Since all of these assumptions and requirements can be met in this design example (pending groundwater table investigations), this step is complete.

**Step 7: Use the Adjusted Curve Number to Address Peak Flow Requirements.**

The original site CN of 94 is reduced for the 2-year, 15-year, and 100-year storms to 70, 77, and 80, respectively, by the retention provided by the bioretention cell. These values can be used to help determine detention requirements for this site.

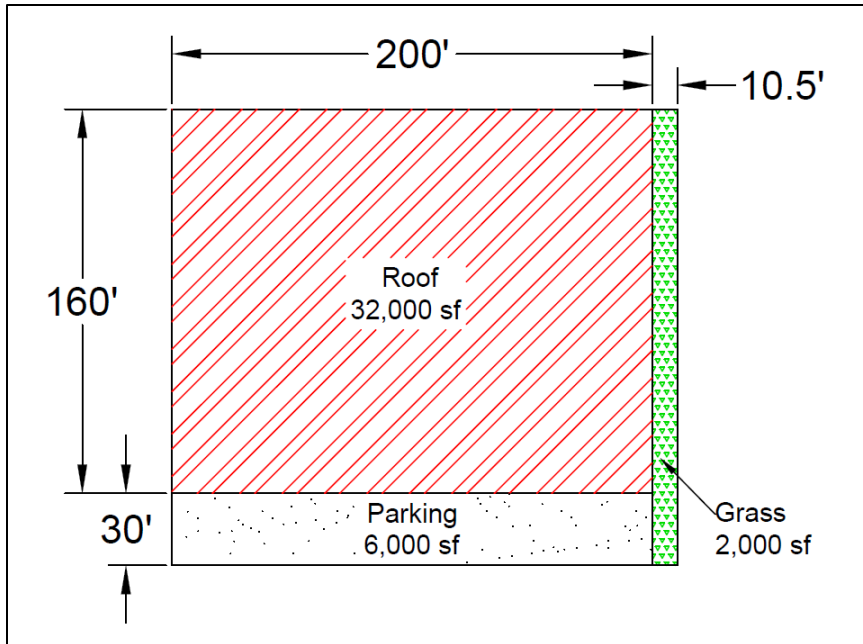
**Step 8: Determine Detention Requirements.**

Detention is not required.

**Design Example 8**

**Step 1: Determine Design Criteria.**

Site Name	Southwest Mixed-Use Development
Total Site Area	40,000 ft <sup>2</sup>
Natural Cover Area	0 ft <sup>2</sup>
Compacted Cover	2,000 ft <sup>2</sup>
Impervious Cover	38,000 ft <sup>2</sup>
Vehicular Access Areas	0 ft <sup>2</sup>
Is site located within the AWDZ?	No
Is site located within the MS4?	No
What type of activity is site undergoing?	Major Land-Disturbing



**Step 2: Input Design Criteria to Determine the Retention and Treatment Requirements.**

Based on the design criteria above, Southwest Mixed-Use Development has the following requirements:

$$SWRv = 3,660 \text{ ft}^3$$

**Step 3: Identify Site Constraints and BMP Restrictions.**

Key considerations for Southwest Mixed-Use Development include the following:

- Groundwater is high, so any BMPs in the ground will be shallow.
- The soil infiltration rates are poor, so underdrains will be required.
- The building roof has several tenant amenities planned that will restrict the area for any stormwater BMPs.
- This site is part of the CSS that is in a sewershed where CSOs will be reduced with storage tunnels.

**Step 4: Select BMPs to Meet the Retention and Treatment Requirements.**

Green roof (G-1) and permeable pavers (P-3) were selected to manage the stormwater.

The site will ultimately have one outlet point, and therefore one SDA.

The roof of the building has several amenities that tenants can access; therefore, the green roof size is restricted to 4,600 square feet. No additional roof area drains to the green roof; the CDA is the green roof area. Since green roofs are typically manufactured systems, several of the parameters, such as the drainage layer depth and maximum water retention of all layers, need to

be provided by the manufacturer. The values for the roof used in this design are provided in the variable descriptions below Equation 3.1 (with each layer illustrated in Figure 3.1).

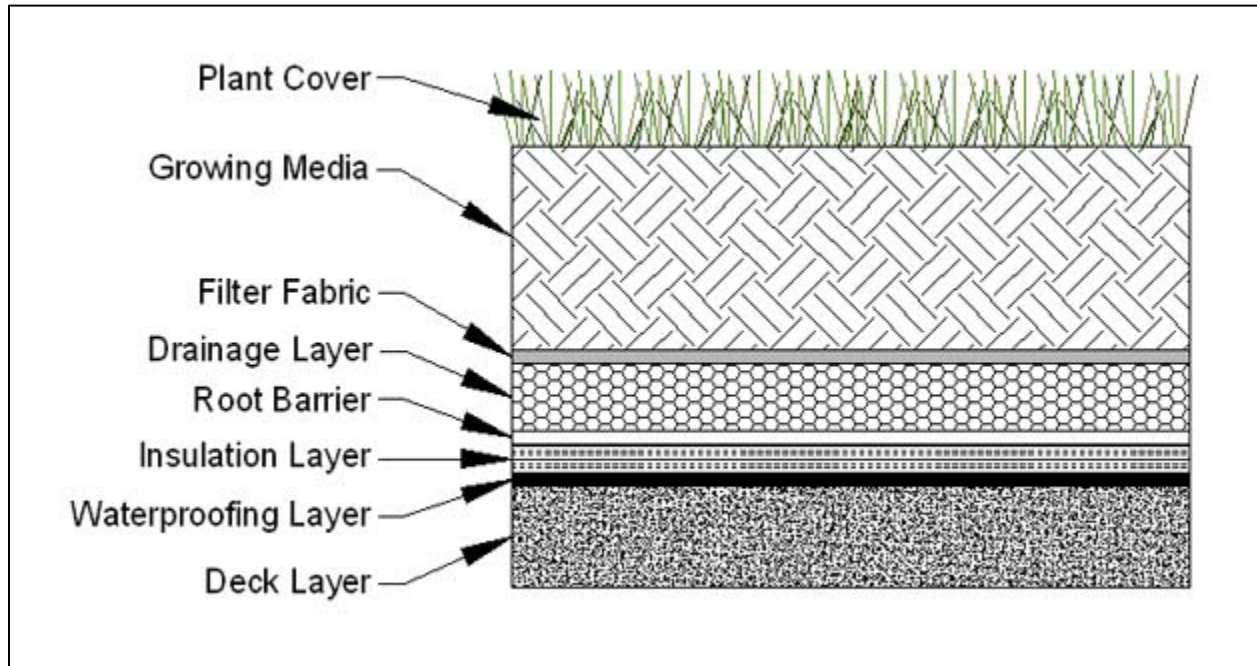


Figure 3.1 Typical layers for a green roof.

**Equation 3.1 Storage Volume for Green Roofs**

$$Sv = \frac{SA \times [(d \times MWR_1) + (DL \times MWR_2)]}{12}$$

where:

- $Sv$  = storage volume (ft<sup>3</sup>)
- $SA$  = green roof area (ft<sup>2</sup>) (4,600 ft<sup>2</sup>)
- $d$  = media depth (in.) (8 in.)
- $MWR_1$  = verified media maximum water retention (0.45)
- $DL$  = drainage layer depth (in.) (1 in.)
- $MWR_2$  = verified drainage layer maximum water retention (0.9)

$$Sv = \frac{4,600 \text{ ft}^2 \times [(8 \text{ in} \times 0.45) + (1 \text{ in} \times 0.9)]}{12} = 1,725 \text{ ft}^3$$

As designed, the green roof has a storage volume of 1,725 cubic feet.

The permeable pavement requires an underdrain and is categorized as a standard design. When designing permeable pavement, ensure that the permeable pavement is sized to store the SWRv in the reservoir layer. The reservoir depth can be determined by using Equation 3.2.

**Equation 3.2 Reservoir Layer or Infiltration Sump Depth**

$$d_p = \frac{\left( \frac{P \times Rv_I \times CDA}{A_p} \right) - (K_{sat} \times t_f)}{\eta_r}$$

where:

- $d_p$  = depth of the reservoir layer (or depth of the infiltration sump for enhanced designs with underdrains) (ft)
- $P$  = rainfall depth for the SWRv or other design storm (ft)
- $Rv_I$  = 0.95 (runoff coefficient for impervious cover)
- $CDA$  = total contributing drainage area, including permeable pavement surface area (ft<sup>2</sup>) (6,000 ft<sup>2</sup>)
- $A_p$  = permeable pavement surface area (ft<sup>2</sup>) (6,000 ft<sup>2</sup>)
- $K_{sat}$  = field-verified saturated hydraulic conductivity for the subgrade soils (ft/day).  
If an impermeable liner is used in the design then  $K_{sat} = 0$ .
- $t_f$  = time to fill the reservoir layer (day) (assume 2 hours or 0.083 day)
- $\eta_r$  = 0.4 (effective porosity for the reservoir layer)

$$d_p = \frac{\left( \frac{0.1 \text{ ft} \times 0.95 \times 6,000 \text{ ft}^2}{6,000 \text{ ft}^2} \right) - (0 \times 2 \text{ hr})}{0.4} = 0.24 \text{ ft} = 2.85 \text{ in}$$

The permeable paver design requires a reservoir depth of 8 inches to support vehicular traffic, so this 8-inch depth will easily store the SWRv.

To determine the total storage volume provided by the practice, Sv, use Equation 3.4.

**Equation 3.4 Permeable Pavement Storage Volume**

$$Sv = A_p [(d_p \times \eta_r) + K_{sat} \times t_f]$$

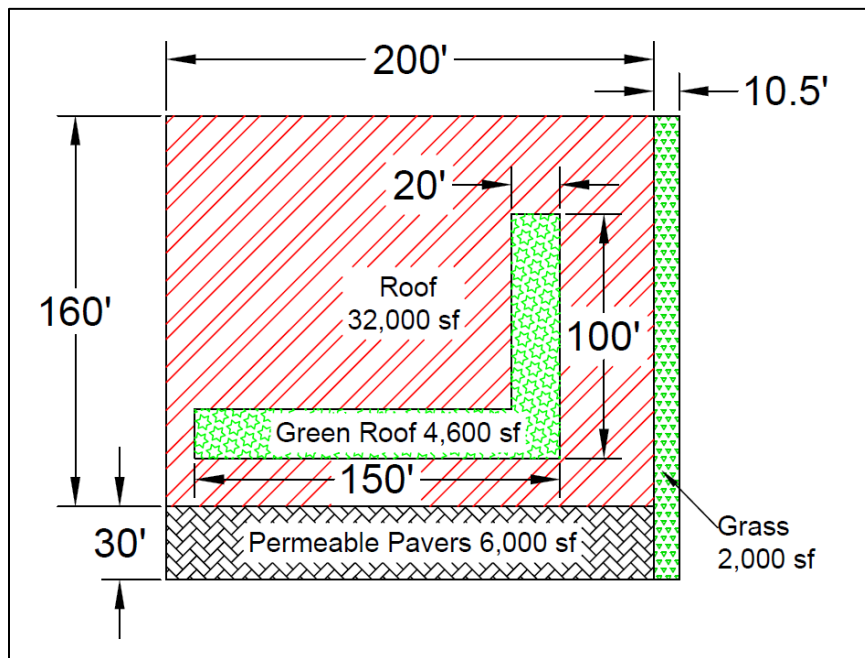
where:

- $Sv$  = storage volume (ft<sup>3</sup>)
- $d_p$  = depth of the reservoir layer (or depth of the infiltration sump for enhanced designs with underdrains) (ft) (0.67 ft)

- $\eta_r$  = 0.4 (effective porosity for the reservoir layer)
- $A_p$  = permeable pavement surface area (ft<sup>2</sup>) (6,000 ft<sup>2</sup>)
- $K_{sat}$  = field-verified saturated hydraulic conductivity for the subgrade soils (ft/day).  
If an impermeable liner is used in the design then  $K_{sat} = 0$ .
- $t_f$  = time to fill the reservoir layer (days) (assume 2 hours or 0.083 days)

$$Sv = 6,000 \text{ ft}^2 \left[ (0.67 \text{ ft} \times 0.4) + 0 \frac{\text{ft}}{\text{day}} \times 0.0083 \text{ days} \right] = 1,608 \text{ ft}^3$$

The surface area of 6,000 square feet should be counted as BMP cover. The total stormwater volume retained on-site by the green roof and permeable pavement is 889 cubic feet, well below the SWRV of 3,660 cubic feet. Less than 50% of the SWRV was retained by the BMPs; however, this site is located in a sewershed in the CSS where CSOs will be reduced with storage tunnels. Therefore, the remaining SWRV can be obtained through Offv without going through the “relief through extraordinarily difficult site conditions” process.



**Step 5: Check Design Assumptions and Requirements.**

Key assumptions and requirements for this site include the following:

- No additional roof runoff drains to the green roof.
- Shallow groundwater and poor infiltration means that the permeable pavement will require an underdrain.

Since all of these assumptions and requirements can be met in this design example, this step is complete.

**Step 6: Use the Adjusted Curve Number to Address Peak Flow Requirements.**

Values for C soils results in a CN of 74 for turf and 98 for impervious cover. The original site CN of 97 is reduced for the 2-year, 15-year, and 100-year storms to 86, 88, and 88, respectively, by the retention provided by the green roof and the permeable pavers. These values can be used to help determine detention requirements for this site.

**Step 7: Determine Detention Requirements.**

Detention is required to reduce the peak discharge rate from the 2-year storm event to the predevelopment (meadow conditions or better) peak discharge rate and to reduce the peak discharge rate from the 15-year storm event to the pre-project peak discharge rate. Appendix I - Acceptable Hydrologic Methods and Models includes details on how to calculate the detention volume. In this example, the proposed runoff CN are less than the pre-project conditions, so detention for the 15-year storm is not required. Detention for the 2-year storm will be required.

The peak inflow ( $q_{i2}$ ) and the peak outflow ( $q_{o2}$ ) can be calculated using the WinTR-55 Small Watershed Hydrology program, the area of the site, the time of concentration ( $T_c$ , assumed to be 10 minutes), and the CNs. The reduced CN of 86, determined above, generates a  $q_{i2}$  of 2.40 cubic feet per second (cfs). The CN for meadow in good condition, 71, generates a  $q_{o2}$  of 1.07 cfs.

The ratio of 1.07 cfs to 2.40 cfs equals 0.46. Using Figure H.1, the ratio of storage volume ( $V_{s2}$ ) to runoff volume ( $V_{r2}$ ) is 0.29.

The runoff volume is 1.83 inches ( $Q_{BMP}$ ), which equates to 6,100 cubic feet ( $V_{r2}$ ). Using the calculated ratio of  $V_{s2}/V_{r2}$ , the storage volume required for the site ( $V_{s2}$ ) is 1,769 cubic feet.

With appropriate orifice design to ensure that outflows are properly restricted, this detention volume may be located elsewhere on the site as a standalone detention practice.





# **Appendix B Maximum Extent Practicable Process for Existing Public Right-of-Way**

## **B.1 Maximum Extent Practicable: Overview**

Maximum extent practicable (MEP) is the language of the Clean Water Act that sets the standards to evaluate efforts pursued to achieve pollution reduction to United States waterbodies. MEP refers to management practices; control techniques; and system, design, and engineering methods for the control of pollutants. It allows for considerations of public health risks, societal concerns, and social benefits, along with the gravity of the problem and the technical feasibility of solutions.

MEP is achieved, in part, through a process of selecting and implementing different design options with various structural and nonstructural stormwater best management practices (BMPs), where ineffective BMP options may be rejected and replaced when more effective BMP options are found. MEP is an iterative standard that evolves over time as urban runoff management knowledge increases. As such, it must be assessed continually and modified to incorporate improved programs, control measures, and BMPs to attain compliance with water quality standards. As a result of this evolution, some end-of-pipe strategies that were considered to meet the MEP standard 10 years ago are no longer accepted as such. Similarly, in cases where just one BMP may have gained project approval in the past, today there are many cases where multiple BMPs will be required to achieve treatment to the MEP.

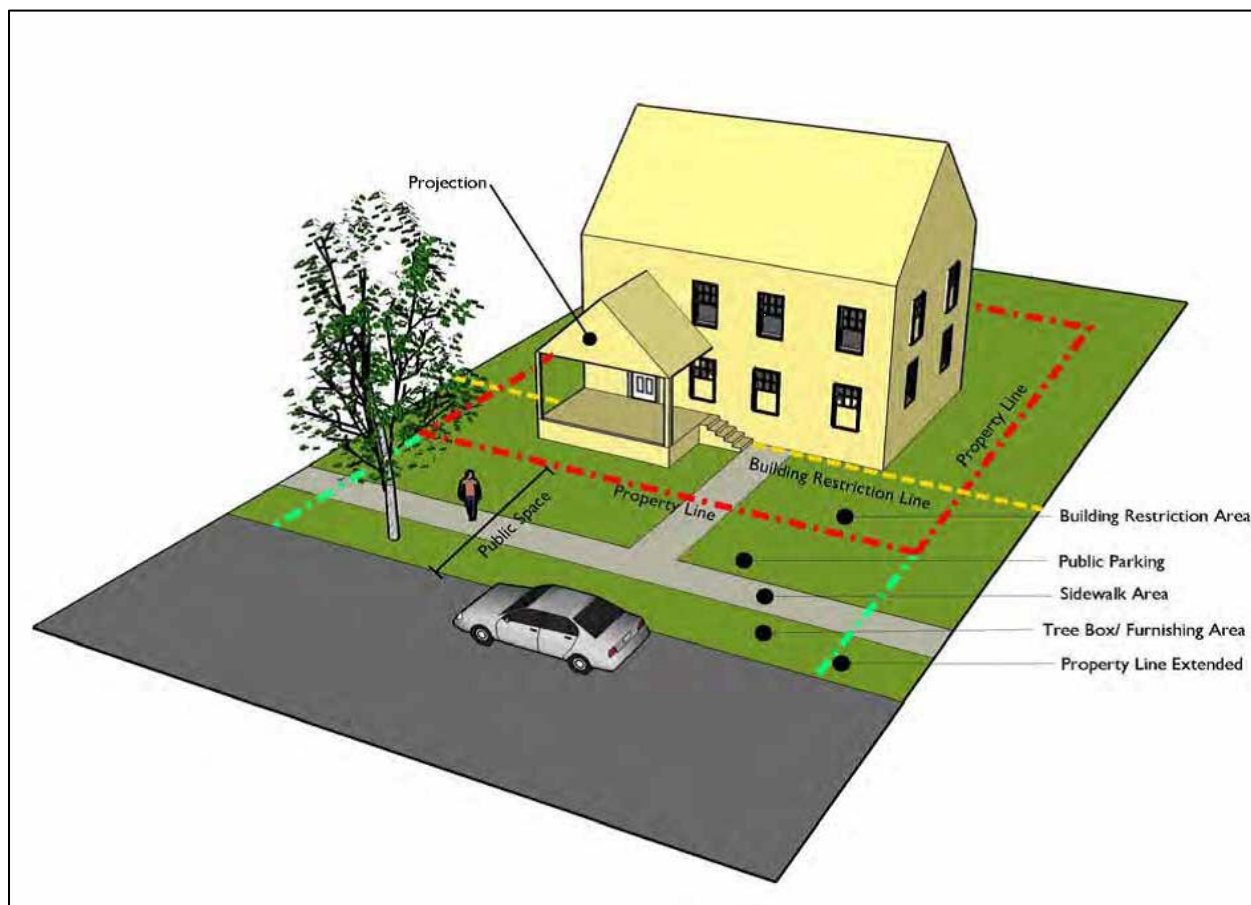
Many jurisdictions have said of the MEP standard that there “must be a serious attempt to comply, and practical solutions may not be lightly rejected.” If project applicants implement only a few of the least expensive BMPs, and the regulated volume has not been retained, it is likely that the MEP standard has not been met. If, on the other hand, a project applicant implements all applicable and effective BMPs except those shown to be technically infeasible, then the project applicant would have achieved retention to the MEP.

## **B.2 Public Right-of-Way Projects**

Public right-of-way (PROW) projects within the District of Columbia are owned and operated by the District Government. They are linear in orientation and are distinct from parcel or lot development.

PROW is defined as the surface, the air space above the surface (including air space immediately adjacent to a private structure located on public space or in a PROW), and the area below the surface of any public street, bridge, tunnel, highway, railway track, lane, path, alley, sidewalk, or boulevard, where a property line is the line delineating the boundaries of public space and private property.

The Public Parking Area or “Public Parking,” is important for the following discussion. It is defined as that area of public space devoted to open space, greenery, parks, or parking that lies between the property line (which may or may not coincide with the building restriction line) and the edge of the actual or planned sidewalk that is nearer to the property line, as the property line and sidewalk are shown on the records of the District (see Figure B.1). This area often includes spaces that appear to be front yards with private landscaping, which create park-like settings on residential streets.



**Figure B.1 Diagram of typical residential public right-of-way in the District of Columbia (DDOT Public Realm Design Manual 2011).**

Public Space is defined as all the publicly owned property between the property lines on a street, park, or other public property, as such property lines are shown on the records of the District, and includes any roadway, tree space, sidewalk, or parking between such property lines (see Figure B.1).

Other important terms are the tree box area or planter area and the sidewalk area. These are defined as the area of the roadside that provides a buffer between the pedestrians and vehicles, which primarily contains landscaping such as a continuous planting strip in residential areas. The sidewalk area is sometimes known as the “pedestrian clear zone,” this is the walking zone adjacent to the tree box that must remain clear, both horizontally and vertically.

In the MEP discussion that follows, a PROW project means a land-disturbing activity conducted in the existing PROW and the existing public space associated with the project. The MEP discussion applies only to those PROW projects required for the operation and maintenance of existing commercial and residential streets, existing alleyways, and other existing transportation infrastructure designed and maintained for the safe conveyance of people and commerce. Private subdivision roads or streets shall not be considered PROW projects.

Construction projects to maintain and upgrade the District's PROW are faced with a multitude of unique site constraints that vary widely. Limited space outside of the roadway restricts opportunities for infiltration and evapotranspiration, and in many cases the width of the roadway cannot be reduced to create additional space. In the roadway itself, the structural integrity of the pavement is the prime concern. The weight and volume of traffic loads may limit the use of permeable pavements.

The PROW occupies approximately 25% of the impervious area of the District of Columbia, making the PROW one of the most significant sources of stormwater runoff impacting District waterbodies. Stormwater runoff from roadways can present high pollutant loading. Despite the challenges to stormwater management faced by PROW projects, it is essential for the protection of District waterbodies to strive to achieve full retention of the regulated stormwater volume through the use of BMPs to the MEP on all PROW projects. This means the design process of all PROW projects shall evaluate and implement all applicable and effective BMPs except those shown to be technically infeasible.

The aim for full retention on site of a PROW project's regulated stormwater volume is consistent with the District of Columbia Department of Transportation's (DDOT's) "Complete Streets" policy that states, "improvements to the right-of-way shall consider [...] environmental enhancements including, reducing right-of-way stormwater runoff, improving water quality, prioritizing and allocating sustainable tree space and planting areas (both surface and subsurface), [...] wherever possible." It is also an effort consistent with the District's 2012 municipal separate storm sewer system (MS4) permit, which sets requirements to install BMPs in the PROW.

The sections that follow, Design Considerations and Design Process, are intended to provide structure for planners, designers, and reviewers to evaluate whether or not a PROW project has exhausted every opportunity to achieve the full retention of the regulated stormwater volume. Achieving the regulated Stormwater Retention Volume (SWR<sub>v</sub>) in the PROW projects will be technically infeasible on many occasions, even after going through the MEP process. Given this and the compelling interest of the ongoing reconstruction of the PROW for the maintenance of public safety and well-being, PROW projects can be excluded from the requirement to use Stormwater Retention Credits (SRCs) or pay an in-lieu fee to satisfy any shortfall in attaining the SWR<sub>v</sub> if the MEP is demonstrated. These PROW projects are the only type of projects that are excluded from this requirement.

DOEE's MEP process applies to two types of projects. Type 1 projects solely involve reconstruction of the existing PROW, such as DDOT reconstructs multiple blocks of a roadway. Type 2 designates parcel-based development projects that reconstruct the adjacent, existing PROW as portion of the project. Under the MEP process for Type 2 projects, the parcel portion

of the application will be reviewed under the full stormwater management performance standards defined in Chapter 2, “Minimum Control Requirements,” while the PROW portion of the application will be reviewed under the MEP Type 2 approach defined in this appendix.

The General Retention Compliance Calculator has a separate PROW worksheet that allows Type 2 applicants to separate parcel drainage area obligations from PROW obligations. The Compliance sheet also presents these drainage areas separately to simplify the review process and make it transparent. The Stormwater Database has an option on the Plans form to indicate if the SWMP is a “roadway reconstruction or similar project.” Also, on the Site Drainage Areas page, there is a check box indicating that the “Site Drainage Area is in the Public Right-of-Way.” To request an MEP Type 2 review, an applicant will submit a request memo with supporting evidence that describes why the full SWRV cannot be retained in addition to the completed worksheets from the General Retention Compliance Calculator.

The memo must address the six design steps described in Section B.5, “Design Process for PROW.” Type 2 applicants can choose to follow the same table, plan view, and narrative approach identified for Type 1 applicants without the multiple-stage review process for the 30%, 65%, and 90% design phases. Type 1 projects will use a stormwater report that contains information in spreadsheet, plan view, and narrative formats for the submission and review of the 30%, 65%, and 90% design stages, typically of DDOT projects. Table B.3 indicates the information and submission format expected at each review stage.

### B.3 Codes

DDOT uses a “functional street classification” system that is defined in Chapter 30 of the Transportation Design and Engineering Manual. There are five functional categories including Freeways, Principal Arterials, Minor Arterials, Collector Streets, and Local Streets. Table B.1 shows relative distribution of roadway classifications in the District. Each type has design criteria that are governed by traffic volumes, land use, and expected growth. These design criteria set the acceptable ranges for geometric design elements that will govern roadway geometry. The MEP process assumes transportation design criteria govern when conflicting demands exist.

**Table B.1 Roadway Classification and Extent Relative to Total Roadway System**

Type	Approximate Miles	% of District Roadway System
Freeways	46	4
Principal Arterials	92	8
Minor Arterials	178	15
Collectors	152	13
Local Roads	682	60

The MEP process assumes BMP designs will comply with the DDOT Design and Engineering Manual Chapter 28 and the Design and Engineering Manual supplements for Low Impact

Development and Green Infrastructure Standards and Specifications as well as Chapter 3 Stormwater Best Management Practices (BMPs) in this guidebook.

## **B.4 PROW Design Considerations**

### **B.4.1 Considerations in the Planning Process (limited to Type 1)**

The local capital authority for PROW projects is defined in the District of Columbia's Capital Improvement Program (CIP), a 6-year-plan that is updated annually. Federally funded projects are listed in the Transportation Improvement Program (TIP), which is updated every other year according to the Metropolitan Washington Council of Government National Capital Region Transportation Planning Board's (MWCOTG TPB) schedule and is also coordinated with the Constrained Long-Range Transportation Plan (CLRP). Each planning stage has an amendment process. Planners shall incorporate the MEP process into all future PROW projects and shall review and revisit, as needed, existing PROW plans for MEP analysis, revisions, and amendments. The TIP and CLRP are able to be amended and modified as allowed by the MWCOTG TPB. As projects move from study to design and construction, DDOT will include necessary measures to include MEP analysis and implementation.

### **B.4.2 Site Assessment Considerations for the Retention Standard in PROW Projects**

- 1. Level of Disturbance (Type 1 and Type 2).** If a PROW project includes major land-disturbing activity required for the operation and maintenance of existing commercial and residential streets, existing alleyways, and other existing transportation infrastructure designed and maintained for the safe conveyance of people and commerce, it is captured by the stormwater regulatory obligations of Chapter 5 of Title 21, of the District of Columbia Municipal Regulations. Routine maintenance such as surface asphalt milling of roadways, where the roadway base is not disturbed, is not considered a level of disturbance that will require compliance with the regulation.
- 2. Available Space (Type 1 and Type 2).** A PROW project must first and foremost seek to maximize landscape areas, maximize available space for stormwater retention, and minimize impervious surface, while coordinating with transportation, access, safety, and other applicable requirements, such as the Americans with Disabilities Act (ADA) requirements and emergency vehicle needs. Street widths should be reduced to the appropriate minimum width while maintaining multi-modal transportation needs, parking, and public safety. A rule of thumb used in some cities (e.g., Los Angeles, Portland, Seattle, and Philadelphia) equates the expected landscape space to a minimum percentage of the imperviousness within each site drainage area (SDA) within the PROW project limits of disturbance. This percentage ranges from 4%–10%.

In the District of Columbia, several hundred triangular islands less than 1 acre in area are created by diagonal street intersections. A PROW project must consider the opportunity for stormwater retention within traffic islands or triangle parks that fall within or adjacent to the project limits of disturbance. Streets that end as cul-de-sacs are less prevalent in the District; however, when present, cul-de-sacs within or adjacent to the limits of disturbance of a PROW project must be evaluated for stormwater retention opportunities. In the District "paper streets" exist throughout, as areas of the City dedicated as streets but not useable as

transportation passageways. These areas, under the control of the DDOT, may be created by the intersection of streets with parks and streams, and are often mowed grass areas. “Paper streets” within, or adjacent to, the limits of disturbance of a PROW project must be evaluated for stormwater retention opportunities.

- 3. Impervious Cover Removal (Type 1 and Type 2).** The elimination of impervious surface may be accomplished by closing diagonal roadways adjacent to triangle parks to create larger parks. Diagonal roadways that are adjacent to triangle parks and fall within, or are adjacent to, a PROW project must be evaluated for stormwater retention opportunities. PROW projects must evaluate the opportunity to integrate traffic calming measures including but not limited to, median islands, pedestrian curb extensions, bump outs and chicanes, and turning radius reductions that may double as areas for impervious surface removal and BMPs.

Replacing impervious cover with landscape area in the contributing drainage area (CDA) converts the runoff coefficient from 95% to 25%, in essence decreasing that area’s contribution to stormwater runoff by 70% without the use of an active stormwater facility. If an area can be converted to “natural cover” through conservation and reforestation strategies, that area’s contribution to stormwater runoff is reduced to zero. Consult Appendix O - Land Cover Designations for minimum thresholds and other requirements for each land cover designation. Further opportunities to reduce stormwater runoff in these CDAs should be explored with adjacent property both public and private as source control may be the most cost-effective approach to managing stormwater runoff (see Section 3.4 Impervious Surface Disconnection).

- 4. Drainage Areas (Type 1 and Type 2).** Overall conceptual drainage plans for PROW projects should identify SDAs outside of the project’s limits of disturbance that generate runoff that may comingle with on-site runoff. The project is not required to consider off-site runoff in the calculation for the regulated SWRv; however, BMPs sized for retention of comingled off-site runoff can be used to offset the inability to capture and retain the SWRv in areas within the project for which significant constraints prevent retention.

For example, a typical city block will have at least two distinct SDAs created by the crown in the center of the road. While one side of the road may have significant obstacles to the implementation of retention practices, the other may not. If the limits of disturbance are defined by the boundaries of the sidewalks on either side of the roadway, this is the area that is used to calculate the SWRv. However, in many circumstances stormwater runoff is entering the sidewalk and roadway from adjacent properties, both public and private, creating a comingled stormwater runoff. Under these conditions the side of the street that has the greater opportunity to implement retention strategies shall be designed to manage that comingled volume up to the full SWRv.

Type 1 and Type 2 projects must prioritize capturing roadway runoff. For Type 2 projects, where limits of disturbance do not extend into the roadway, the capture of roadway runoff from adjacent roadway CDAs may be accomplished with curb cuts or sidewalk trenches used to direct roadway runoff from the curb line into sidewalk BMPs within the project’s limits of disturbance. This must be the first consideration to satisfy the SWRv calculated for the project’s PROW portion.

- 5. Ownership of Land Adjacent to Right-of-Ways (limited to Type 1).** The opportunity to incorporate stormwater retention may depend on the ownership of land adjacent to the right-

of-way. Acquisition of additional right-of-way and/or access easements may only be feasible if land bordering the project is publicly owned. PROW projects must identify public lands and public rights-of-way adjacent to the project's limits of disturbance. PROW project planners and managers may need to consult with adjacent public property owners and managers to evaluate opportunities to direct stormwater runoff from the project SDA to adjacent public lands.

- 6. Location of Existing Utilities (Type 1 and Type 2).** The location of existing storm drainage utilities (gray infrastructure) can influence the opportunities for stormwater retention in PROW projects. Utilizing the existing gray infrastructure for the conveyance of large events with underdrain connections and curb line overflows can reduce costs. Using existing gray infrastructure, where possible, frees funds for SDAs within the project limits of disturbance where gray infrastructure does not exist or is more challenging to utilize. Standard peak-flow curb inlets, such as catch basins, should be located downstream of areas with potential for stormwater retention practices so that water can first flow into the BMP, and then overflow to the downstream inlet if capacity of the BMP is exceeded. It is more difficult to apply retention practices after water has entered the storm drain. The location of other utilities will influence the ability to connect BMPs to storm drains, and may limit the allowable placement of BMPs to only those areas where a clear pathway to the storm drain exists.

The following outlines an approach to take when considering the design and location of BMPs in the existing PROW relative to existing utilities: 1) avoidance; 2) mitigation; 3) relocation; and 4) acceptance.

**Avoidance.** Whenever possible, locate BMPs to avoid a conflict that either jeopardizes the functionality and longevity of the utility or complicates future utility maintenance. Consult with each utility company on their recommended offsets that will allow utility maintenance work with minimal disturbance to the BMP. A consolidated presentation of the various utility offset recommendations can be found in Chapter 28.8.4.4 of the District of Columbia Department of Transportation Design and Engineering Manual, latest edition. Consult the District of Columbia Water and Sewer Authority (DC Water) Green Infrastructure Utility Protection Guidelines, latest edition, for water and sewer line recommendations. Avoidance of utility conflicts may mean one BMP type is selected over another. It may mean the sizing of a BMP is altered.

**Mitigation.** Under the mitigation approach the BMP design is adjusted to mitigate utility concerns. A BMP design may need to be resized or otherwise altered to satisfy utility offsets. This may include moving, adding, or deleting a key design feature of the BMP such as check dams, inlets, outlets, and trees.

**Relocation.** Under the relocation approach an attempt is made to coordinate with utility companies to allow them to replace or relocate their aging infrastructure while BMPs are being implemented. Where the capital budget and priorities of the utility can be aligned with the larger construction in the PROW, there are potential benefits, including cost savings, for both the utility and the entity undertaking the reconstruction of the PROW. The age of the utility line is a factor in selecting this solution. While a utility relocation during a street reconstruction project may be advantageous to the utility provider, it is understood that the utility may not be able to align its capital budget or may be otherwise unable or unwilling to take advantage of the relocation opportunity.

**Acceptance.** When the first three approaches are inadequate to achieve the required stormwater retention, consider a fourth approach, acceptance of conflicts that do not jeopardize the functionality, longevity, and vehicular access to manholes and other key points of utility maintenance. This does not preclude the typical PROW BMP such as street trees, bioretention, or permeable pavement that the utility would be expected to replace if maintenance in those areas was required. In this scenario, a BMP location and design that complicates utility maintenance should be considered acceptable if it does not compromise the utility function, longevity, and major access points. When accepting utility conflict into the BMP location and design, it is understood the BMP will be temporarily impacted during utility work but the utility will replace the BMP or, alternatively, install a functionally comparable BMP according to the specifications in the current version of this guidebook and the DDOT Design and Engineering Manual with special attention to Chapter 28 and the Design and Engineering Manual supplements for Low Impact Development and Green Infrastructure Standards and Specifications. To clarify whether a conflict jeopardizes the functionality, longevity, and access to a utility consider the latest editions of the DDOT Design and Engineering Manual and the DC Water Green Infrastructure Utility Protection Guidelines.

- 7. Grade Differential between Road Surface and Storm Drain System (Type 1 and Type 2).** Some BMPs require more head from inlet to outlet than others; therefore, allowable head drop may be an important consideration in BMP selection. Storm drain elevations may be constrained by a variety of factors in a roadway project (utility crossings, outfall elevations, etc.) that cannot be overcome and may override SWRV considerations.
- 8. Longitudinal Slope (limited to Type 1).** The suite of BMPs that may be installed on steeper road sections is more limited. Specifically, permeable pavement and swales are more suitable for gentle grades. Other BMPs may be more readily terraced to be used on steeper slopes. Check dams and weirs should be incorporated into BMP designs on steeper slopes.
- 9. Potential Access Opportunities (limited to Type 1).** A significant concern with the installation of BMPs in high speed, high volume PROW is the ability to safely access the BMPs for maintenance considering traffic hazards. A PROW project involving high speed, high volume PROW should include a site assessment to identify vehicle travel lanes and areas of specific safety hazards for maintenance crews. Subsequent steps in the preparation of the Stormwater Management Plan (SWMP) for the PROW project should attempt to avoid placing BMPs in these areas.
- 10. Tree Canopy and Vegetation (Type 1 and Type 2).** Concern for the preservation of existing mature trees is a reasonable consideration when determining where and how to direct stormwater runoff from the curb line for retention goals in a PROW project. In general, stormwater retention practices should be installed outside the drip line of existing trees (more specific guidance is provided in Section 3.14, “Tree Planting and Preservation”). A guiding principal for PROW projects should be the improvement and maintenance of the most robust tree canopy possible along the PROW. The planting of trees and the preservation of trees should look to the latest science on the soil volume requirements, spacing needs, and methods to connect stormwater runoff to tree roots to support healthy vigorous tree growth. PROW projects should clearly identify existing healthy trees and detail how to prevent tree losses during construction. Additionally, diseased and dead trees should be removed. Soils in



tree planting areas should be amended and volumes expanded whenever trees are replaced or new trees are planted.

- 11. Infiltration (Type 1 and Type 2).** Infiltration practices have very high storage and retention capabilities when sited and designed appropriately. Designers should evaluate the range of soil properties during initial site layout and seek to configure the site to conserve and protect the soils with the greatest recharge and infiltration rates. In particular, areas of hydrologic soil group (HSG) A or B soils shown on NRCS soil surveys should be considered as primary locations for infiltration practices. When designing a PROW project consult Appendix P - Geotechnical Information Requirements for Underground BMPs, and Section 3.8 Infiltration, as well as sections on specific BMPs under consideration in this guidebook for specific design details and constraints.

In areas where a qualified professional engineer, soils scientist, or geologist determines during an initial feasibility test the presence of soil characteristics that support the categorization as D soils, no further investigation is required. A designer of a PROW project should first consider reducing the impervious surface area draining to these poor soil areas. Other soil types may require further analysis to determine infiltration feasibility. It is important to understand that areas with poor soils may still be sites for BMPs that are designed with underdrains.

If the seasonally high water table is determined to be less than 2 feet from the bottom of the proposed BMP, infiltration and some other BMPs may not be appropriate. This may be determined through a comparison of historic and actual elevations. If the site is one of known soil contamination or receiving uncontrolled stormwater runoff from a land use hotspot, as determined by guidance in Appendix Q - Stormwater Hotspots infiltration must not be used.

- 12. Street Profile (limited to Type 1).** The profile of an impervious surface such as a street or an alleyway determines how stormwater runoff flows off the surface. District streets follow a crowned design with the high point in the center draining to both sides, alleyways are typically reverse crowned, draining to the center, and sidewalks side shed, draining to one side. Flat drainage is a term used to denote vertical drainage through a permeable pavement profile. A PROW project should consider all variations of drainage patterns when the standard drainage design does not provide retention for the full regulated SWRV. The drainage patterns of the project should be developed so that drainage can be routed to areas with BMP opportunities before entering storm drains. For example, if a median strip is present, a reverse crown should be considered, so that stormwater can drain to a median swale.

- 13. Pedestrian Circulation (Type 1 and Type 2).** The design of stormwater retention facilities should harmonize with effective pedestrian circulation in PROW projects. PROW project BMPs commonly integrate the goals of stormwater retention and pedestrian safety by reducing pedestrian crossing distances, providing more space against vehicular traffic, and improving site angles at intersections. While pedestrian circulation and stormwater retention should not be at odds, conflicts can arise with on street parking. Considerations should be given to provide adequate egress for parking adjacent to a BMP (typically 2 feet). In addition, frequent walkways across BMPs can give pedestrians sufficient access to parking zones.

Retention facilities with vertical drops of greater than 6 inches in a PROW project should provide pedestrians with visual or physical signals that denote a significant drop in grade, such as a raised curb edge, a detectable warning strip or a raised railing. Railings may be designed to perform additional functions such as seating or bicycle racks. In areas with the potential for high pedestrian volume, railings may be needed to prevent pedestrians from cutting through landscaped areas, trampling vegetation, and compacting soils.

#### **B.4.3 Fundamental Tenets of MEP for PROW**

A PROW project shall demonstrate a design approach that indicates stormwater retention opportunities were evaluated to the MEP, which includes the following:

- Selecting BMPs based on site opportunities to reduce stormwater runoff volumes.
- Sizing BMPs opportunistically to provide the maximum stormwater retention while accounting for the many competing considerations in PROW projects.
- Prioritizing capturing roadway runoff (by managing comingled stormwater runoff within some SDAs to offset minimum retention achieved in other SDAs).
- Developing innovative stormwater management configurations integrating “green” with “gray” infrastructure.
- Minimizing street width to the appropriate minimum width for maintaining traffic flow and public safety.
- Maximizing tree canopy by planting or preserving trees/shrubs, amending soils, increasing soil volumes, and connecting tree roots with stormwater runoff.
- Using porous pavement or pavers for low traffic roadways, on-street parking, shoulders, or sidewalks.
- Integrating traffic calming measures that serve as stormwater retention BMPs.
- Reducing stormwater runoff volume by converting impervious surfaces to land cover types that generate little or zero stormwater runoff.
- Reducing stormwater runoff volume by employing impervious surface disconnection strategies within and adjacent to the project’s limits of disturbance.

#### **B.4.4 Minor Disturbances in the PROW**

Some PROW disturbances, particularly Type 2 disturbances, may be considered minor disturbances in which there is little or no opportunity for the incorporation of stormwater BMPs. Utility trenches and driveways are two of the most common occurrences of this type of disturbance.

In the case of utility trenches, as noted in Section 2.12.7, “Utility Work,” “land-disturbing activities that consist solely of cutting a trench for utility work and related replacement of sidewalks and ramps are exempt from stormwater management requirements if the activity does not involve the reconstruction of a roadway from curb to curb or curb to centerline of roadway.” This means that MEP requirements do not apply if the PROW disturbance is limited to the utility work, unless the work requires reconstruction of at least half the roadway (curb to centerline).

For disturbance that involves only the installation or replacement of a driveway there are no exemptions, and MEP requirements still apply, even if the disturbance is minor. However, it is understood that disturbance limited solely to a driveway will generally yield little or no opportunity for stormwater BMPs. In these cases, a statement on the SWMP that no disturbance will occur beyond the limits of the driveway, leaving no space for BMP installation, may be considered sufficient to meet the MEP process requirements. If the disturbance extends beyond the limits of the driveway, a more thorough MEP analysis will be necessary.

#### **B.4.5 Design Modifications for Infiltration-Based PROW BMPs for Type 1 Projects**

The MEP process allows PROW projects to comply with stormwater management volume requirements by demonstrating through the design iteration process that all practicable opportunities for BMPs have been exhausted, and the project is providing as much green infrastructure as is reasonably possible. Because of this, the MEP process can allow for some alternatives with regard to design of infiltration-based BMPs. More specifically, with the design modifications described below, infiltration-based BMPs can be designed and installed without first determining a field-verified hydraulic conductivity, which may lead to cost savings for the project. The following design modifications are allowed for MEP Type 1 projects only.

- **Sidewalk Permeable Pavement.** Permeable pavement in pedestrian areas can be installed without an underdrain, regardless of the saturated hydraulic conductivity of the soils below. This type of design will provide an opportunity for infiltration of as much runoff as possible, and any runoff that cannot infiltrate will either be held in the reservoir or run off the surface like regular pavement. Since this design modification is for pedestrian areas only, concerns over saturated soils and pavement or frost heave are minimized.

Sidewalk permeable pavement that has been designed without field-verified saturated hydraulic conductivity value will be considered a standard design with respect to retention value calculations, receiving the conservative standard design value of 5.0 cubic feet per 100 square feet of practice area.

- **Bioretention with Capped Underdrain.** Bioretention can be installed in the PROW regardless of the saturated hydraulic conductivity of the soils below. In order to do this, the bioretention area must include an underdrain and a 6-inch deep (minimum) infiltration sump, and the underdrain must be capped. By capping the underdrain, infiltration from the bioretention area will be maximized. If the actual infiltration capacity of the soils proves insufficient for proper function of the bioretention area, the underdrain can be un-capped in the future.

The underdrain must be capped in an accessible location (a manhole or catch basin). An underdrain valve accessible from the surface is also an option, particularly for underdrains that are directly connected to the storm sewer. The underdrain should only be opened if standing water has been observed in the bioretention area more than 48 hours after a rainfall event.

Bioretention with a capped underdrain will be considered a standard design with respect to retention value calculations, receiving the conservative standard design value of 60% of the storage volume of the practice.

With the design modifications described above, permeable pavement and bioretention will automatically achieve as much retention as is reasonably possible. Therefore, assuming that all practicable locations for BMPs have been utilized, they are consistent with the MEP philosophy.

## **B.5 Design Process for PROW**

### ***Step 1: Identify Site Drainage Areas and Calculate SWRv.***

- Define the limits of disturbance for the PROW project.
- Delineate all SDAs both within and contributing to the limits of disturbance for the PROW project. Prioritize SDAs conveying roadway runoff.
- Identify proposed land covers within the limits of disturbance for the PROW project, including impervious cover, compacted cover, and natural cover. Area under proposed BMPs counts as impervious cover. A continuous planter strip may be considered compacted cover, or natural cover; consult Appendix O - Land Cover Designations for the minimum thresholds an area needs to qualify for each designation. Individual street trees may count as compacted cover or as a BMP. Use the General Retention Compliance Calculator PROW worksheet to determine which approach provides the greatest SWRv reduction. Input the results from the General Retention Compliance Calculator into the Stormwater Database.
- Calculate the regulated SWRv based on land cover and area within the limits of disturbance for the entire PROW project. Calculate the portion of the SWRv for each SDA within the limits of disturbance of the PROW project. Calculate any “unregulated” off-site SWRv contributing to the project limits of disturbance.

Note: When off-site stormwater runoff volumes are managed, their reduction will count toward a reduction in the SWRv. Off-site stormwater runoff volumes may be managed at the source or within the project’s limits of disturbance. Prioritize SDAs conveying roadway runoff.

- Consider land conversion and BMP designations in adjacent public lands. While these volumes are not counted in the calculation of the site’s SWRv, if controlled they will count towards the reduction of the site’s SWRv. Identify opportunities for land cover conversions or other source control measures that would reduce these off-site volumes.
- Consider altering the drainage profile if that alteration would increase runoff capture opportunities. This consideration will typically be set aside until all other considerations have been exhausted (limited to Type 1).

### ***Step 2: Evaluate Infiltration.***

- Determine historical and actual water table elevations to evaluate opportunities and restrictions for locating infiltration practices.
- Consult a qualified professional engineer, soil scientist, or geologist to do initial infiltration feasibility tests to identify the areas within the limits of disturbance with hydrologic soil groups that should be preserved and targeted for infiltration BMPs and areas where infiltration BMPs will require amended soils and underdrains.

- Identify any areas within the limits of disturbance where there is a known issue of soil contamination. Infiltration BMPs in these areas are not allowed. Use the guidance in Appendix Q - Stormwater Hotspots to evaluate adjacent land use hotspots that may be a source of uncontrolled contaminants in stormwater runoff.

***Step 3: Demonstrate Full Consideration of Opportunities with Existing Infrastructure.***

- Review substructure maps and utility plans; delineate areas of potential conflict as well as areas without conflict.
- Identify the location and elevation of the existing storm drainage system (gray infrastructure), including catch basins, drain inlets, and manholes in both the SDAs within—and those SDAs contributing stormwater runoff to—the limits of disturbance for the PROW project.
- Identify all existing trees to be preserved. Identify and record tree species, size, and condition.

***Step 4: Demonstrate Full Consideration of Land Cover Conversions and Optimum BMP Placement.***

- Identify traffic islands, triangle parks, median islands, cul-de-sacs, and paper streets within and adjacent to the PROW project's limits of disturbance. These areas can be the focus of land cover conversions and BMP locations (unless within LOD of Type 2; this is limited to Type 1).
- Evaluate the opportunity to integrate traffic calming measures including but not limited to, median islands, pedestrian curb extensions, bump outs and chicanes, and turning radius reductions. Delineate these areas out for consideration for impervious surface removal and BMP facilities. Delineate areas available for additional tree planting. Note whether soil volume increases and amended soils are required (unless within LOD of Type 2; this is limited to Type 1).
- Evaluate right-of-way widths; identify minimum requirements for trails, alleys, roadways, and sidewalks. Delineate sections where existing conditions exceed minimum requirements. These areas can be the focus of land cover conversions and BMP locations (limited to Type 1).
- Select areas delineated as optimum opportunities for land conversion or BMP location.

Note: Land conversions can significantly reduce the project's SWRv without the use of an active stormwater facility. Designate land conversions and recalculate SWRv at the full project scale and the scale of the individual SDAs within the project area.

- Select most appropriate BMP types for each area delineated as optimum opportunities for BMP locations. Consult Table B.2 for potential BMPs recommended by US EPA for "Green Streets," DDOT's AWI Chapter 5 LID, DDOT's LID Action Plan, DDOT's LID Standards and Specifications, and Chapter 3 of this guidebook.

***Step 5: Size BMPs.***

- The following process is used to size BMPs for PROW projects:

1. Delineate CDAs to BMP locations including any area outside the limits of disturbance contributing off-site stormwater runoff volume; prioritize roadway runoff; consider the land covers to compute optimum SWRv. Consider designing to over control retention volume above the regulated requirement of 1.2 inches, up to the regulated ceiling of 1.7 inches.
2. Look up the recommended sizing methodology for the BMP selected in each CDA and use the appropriate BMP section of this guidebook to calculate target sizing criteria.
3. Design BMPs per the appropriate section of this guidebook and the DDOT Design and Engineering Manual.
4. Attempt to provide the calculated sizing criteria for the selected BMPs.
5. If sizing criteria cannot be achieved, document the constraints that override the application of BMPs, and provide the largest portion of the sizing criteria that can be reasonably provided given constraints.

Note: If BMPs cannot be sized to provide the calculated volume for the CDA, it is still essential to design the BMP inlet, energy dissipation, and overflow capacity for the full CDA, including any area contributing off-site stormwater runoff volume, to ensure that flooding and scour is avoided. It is strongly recommended that BMPs that are designed to less than their target design volume be designed to bypass peak flows.

- Aggregate the retention values achieved with the BMPs and compare with the regulated SWRv for PROW project. If the aggregate retention value meets or exceeds the SWRv, the project has meet its regulatory obligation.
- If there is a retention volume deficiency, consider sizing BMPs to manage the comingled volume on site.
- If there is a retention volume deficiency, revisit Design Steps 1 through 4. Increase land conversion areas and BMP facilities. Depending on the extent and complexity of the PROW project, this may require several iterations.

***Step 6: Address Site Drainage Areas Where Zero-Retention Practices Are Installed.***

It is possible—despite following the design considerations, fundamental tenants, and the iterative Steps 1 through 5 of the design process—that SDAs within the proposed limits of disturbance may emerge without any retention practices. If these cases occur in the MS4, those SDAs must incorporate water quality catch basins or other emergent technologies that provide water quality treatment for the SWRv of those SDAs.

**Table B.2 Potential BMPs for Green Streets Projects (modified US EPA)**

BMP Type	Opportunity Criteria for PROW Projects
Street Trees, Canopy Interception	<ul style="list-style-type: none"> <li>▪ Access roads, residential streets, local roads, and minor arterials</li> <li>▪ Drainage infrastructure, sea walls/break water</li> <li>▪ Effective for projects with any slope</li> <li>▪ Trees may be prohibited along high speed roads for safety reasons or must be setback behind the clear zone or protected with guard rails and barriers; planting setbacks may also be required for traffic and pedestrian lines of sight</li> </ul>
Stormwater Curb Extensions / Stormwater Planters	<ul style="list-style-type: none"> <li>▪ Access roads, residential streets, and local roads with parallel or angle parking and sidewalks</li> <li>▪ Can be designed to overflow back to curb line and to standard inlet</li> <li>▪ Shape is not important and can be integrated wherever unused space exists</li> <li>▪ Can be installed on relatively steep grades with terracing</li> </ul>
Bioretention Areas	<ul style="list-style-type: none"> <li>▪ Low density residential streets without sidewalks; along roadways adjacent to park space; well suited for the District’s triangle parks; ramp, slipways and road closings can make good conversion sites</li> <li>▪ May require more space than curb extensions/ planters, consider combing with minimized road widths to maximize bioretention area</li> </ul>
Permeable Pavement	<ul style="list-style-type: none"> <li>▪ Parking and sidewalk areas of residential streets and local roads</li> <li>▪ If significant run-on from major roads is a possibility, ensure design and maintenance protocols accommodate potential TSS loads</li> <li>▪ Should not be subject to heavy truck/equipment traffic</li> <li>▪ Light vehicular access roads and alleyways</li> </ul>
Vegetated Swales (compost amended where possible)	<ul style="list-style-type: none"> <li>▪ Roadways with low to moderate slope or terraced systems</li> <li>▪ Residential streets with minimal driveway access</li> <li>▪ Minor to major arterials with medians or mandatory sidewalk set-backs</li> <li>▪ Access roads</li> <li>▪ Swales running parallel to the storm drain can have intermittent discharge points to reduce required flow capacity</li> </ul>
Filter Strips (amended road shoulder)	<ul style="list-style-type: none"> <li>▪ Access roads</li> <li>▪ Major roadways with excess PROW</li> <li>▪ Not practicable in most PROWs because of width requirements</li> </ul>
Proprietary Biotreatment	<ul style="list-style-type: none"> <li>▪ Constrained PROWs; typically have small footprint to CDA ratio</li> <li>▪ Simple install and maintenance</li> <li>▪ Can be installed on roadways of any slope</li> <li>▪ Can be designed to overflow back to curb line and to standard inlet</li> </ul>
Infiltration Trench	<ul style="list-style-type: none"> <li>▪ Constrained PROWs</li> <li>▪ Can require small footprint where soils are suitable</li> <li>▪ Low to moderate traffic roadways</li> <li>▪ Infiltration trenches are not suitable for high traffic roadways</li> <li>▪ Requires robust pretreatment</li> </ul>

## B.6 Summary of MEP Type 1 Submission Process

Table B.3 MEP Type 1 Submission Elements and Review Points

	Stormwater Report Design Phases								
	30%			65%			90%		
Process Steps	Table	Plan	Narrative	Table	Plan	Narrative	Table	Plan	Narrative
<b>Step 1: Identify Site Drainage Areas and Calculate SWRV</b>									
SDA count	I		I	R		R	F		F
SDA list and SWRV per SDA	I			R			F		
Project LOD		I			R			F	
SDAs within LOD		I			R			F	
SDAs outside LOD		I			R			F	
Land cover in LOD	I			R			F		
Volume calculated per SDA inside LOD	I			R			F		
Volume calculated per SDA outside LOD	I			R			F		
Will altered drainage profile increase SWRV?		I	I		R	R			F
Consider adjacent public lands		I			R	R			F
<b>Step 2: Evaluate Infiltration</b>									
Water table conflict per SDA (Y/N)	I		I	R		R	F		F
Bedrock conflict per SDA (Y/N)	I		I	R		R	F		F
Hydro soil group per SDA (Y/N)	I		I	R		R	F		F
Hotspot concern noted (Y/N)	I		I	R		R	F		F
Water table impact (Y/N)					R	R	F	F	
Initial infiltration feasibility tests—opportunities and restrictions? (Y/N)					R	R		F	
Identify adjacent land use hotspots (Y/N)		I			R	R		F	
<b>Step 3: Demonstrate Full Consideration of Existing Infrastructure</b>									
Utility plans		I			R			F	
Utility conflicts		I			R			F	
Existing sewer infrastructure elevations		I			R			F	
Existing Trees	I	I			R			F	
<b>Step 4: Demonstrate Full Consideration of Land Cover Conversions and Optimum BMP Placement</b>									
Land conversion and BMP placement		I	I		R	R		F	F
Count of BMPs and land conversions	I			R			F		



	Stormwater Report Design Phases								
	30%			65%			90%		
Process Steps	Table	Plan	Narrative	Table	Plan	Narrative	Table	Plan	Narrative
<b>Step 5: Size BMPs</b>									
BMP CDAs within LOD and outside LOD (Y/N)					I			R	
Consider over control of SWRv (Y/N)						I			R
Achieve BMP sizing criteria (Y/N)						I			R
Design sizing achieved (under/over)				I			R		
Sizing constraints						I			R
<b>Step 6: Address SDAs with Zero-Retention Practices Installed</b>									
SWRv achieved per SDA				I		I	F		F

Notes:

I = Initial findings and presentation; this should define known facts and best opportunities.

R = Revisions based on further investigations and review comments; this will include some firm commitments.

F = Final design decisions based on initial commitments, interim reviews, and final findings.

The process outlined in this table leads to a final submission of 100% design SWMP as required for the building permit.

SDA = Site Drainage Area, LOD = limits of disturbance, SWRv = stormwater retention volume

## B.7 References

District of Columbia Department of Transportation, 2010, Anacostia Waterfront Transportation Architecture Design Guidelines, Chapter 5: Low Impact Development (LID). Washington D.C. <http://www.scribd.com/doc/83991242/Anacostia-Waterfront-Transportation-Architecture-Design-Guidelines>

County Council for Montgomery County, Maryland. 2007. Streets and Roads—comprehensive revision. Enacted July 3, 2007. Montgomery County, MD. <http://www.montgomerycountymd.gov/COUNCIL/Resources/Files/bill/2007/48-06e.pdf>

District of Columbia Department of Transportation (DDOT). Public Realm Design Manual 2011. <https://ddot.dc.gov/PublicRealmDesignManual>

Environmental Services City of Portland, 2008, Green Streets Construction Guide. Portland, OR. <http://www.portlandoregon.gov/bes/article/228860>

Philadelphia Water Department, Office of Watersheds, 2009, Stormwater Manual v2.0 Chapter 6.1 Street Design. Philadelphia, PA. <http://www.scribd.com/doc/13322624/Stormwater-Management-Guidance-Manual-Ver-20>

Environmental Services City of Portland, 2008, Green Streets Construction Guide. Portland, OR. <https://www.portlandoregon.gov/bes/34602>

City of Los Angeles, 2009, Green Streets & Green Alleys: design guidelines standards. Los Angeles, CA. [http://www.lastormwater.org/wp-content/files\\_mf/greenstreetguidelines.pdf](http://www.lastormwater.org/wp-content/files_mf/greenstreetguidelines.pdf)

Santa Ana Regional Water Quality Control Board, May 19, 2011. Exhibit 7.III Technical guidance document for the preparation of conceptual/preliminary and/or project water quality management plans (WQMPs); Santa Ana County, CA.  
<http://www.cityoforange.org/534/Water-Quality-Management-Plans>

San Francisco Planning Department, 2010, San Francisco Better Streets Plan, Final Draft, 2010, [http://www.sf-planning.org/ftp/BetterStreets/proposals.htm#Final\\_Plan](http://www.sf-planning.org/ftp/BetterStreets/proposals.htm#Final_Plan)

San Mateo Countywide Water Pollution Prevention Program, San Mateo County Sustainable Green Streets and Parking Lots Guide, 2009; San Mateo, CA.  
<http://www.flowstobay.org/node/412>

U.S. Environmental Protection Agency, Managing Wet Weather with Green Infrastructure Municipal Handbook, Green Streets, EPA Publication 833-F-08-009, 2008;  
[https://www.epa.gov/sites/production/files/2015-10/documents/gi\\_munichandbook\\_green\\_streets.pdf](https://www.epa.gov/sites/production/files/2015-10/documents/gi_munichandbook_green_streets.pdf)

# Appendix C Practicable Process

## C.1 Introduction

### C.1.1 Practicability Definition

The term practicable in the context of the District's stormwater management requirements means that a reasonable effort has been made to retain runoff from the project area on site. This appendix provides a step-by-step process for designers to demonstrate the project has met the Practicable standard.

Practicability is very project-specific. The design team and the DOEE plan reviewer work together early in the design process to achieve a mutual understanding of what is practicable for a given project.

Projects types and their conditions for being allowed under the Practicable Process are identified in Chapter 2.13.

### C.1.2 Practicable Factors and Considerations

The Practicable standard is different but similar to the Maximum Extent Practicable (MEP) standard for projects in the Public Right of Way (PROW) described in Appendix B - Maximum Extent Practicable Process for Existing Public Right-of-Way. The MEP standard requires that best management practices (BMPs) be installed wherever there is sufficient space without fundamental constraints (e.g. underground utilities or travel lanes). The Practicable standard is more flexible. While many of the constraints that would apply to an MEP analysis will also apply to a practicable analysis, other constraints and considerations also apply. In total, the Practicable process considers the following factors:

1. Data on soil and groundwater contamination;
2. Data from percolation testing;
3. Documentation of the presence of utilities requiring impermeable protection or a setback;
4. Evidence of the applicability of a statute, regulation, court order, pre-existing covenant, or other restriction having the force of law;
5. Likelihood of runoff from the site to cause erosion of land, transport of sediment, nuisance flooding;
6. Usability of space to achieve the proposed project purpose;
7. Lack of the minimum CDA required for a BMP to be effective;
8. Difficulty of conducting BMP maintenance;
9. Evidence of the sensitivity of receiving waterbody to stormwater runoff;

## C.2 Practicable BMPs

Not all BMPs are practicable for a given project type. Any BMP that provides retention may be installed, but BMPs that are inherently inappropriate or expensive are not required to be considered in a Practicable analysis. The following BMPs must be considered in a Practicable analysis are prioritized below.

- a. Infiltration
- b. Enhanced Bioretention
- c. Standard Bioretention
- d. Impervious Surface Disconnection
- e. Tree Planting and Preservation

Feasibility criteria for each BMP as outlined in Chapter 3 shall be used as the starting point to determine whether site conditions will permit the use of each BMP. Further considerations for a Practicable determination for each BMP are described below:

- a. Infiltration trenches. Infiltration trenches need only be considered in NRCS Type A or B soils. Where Type A or B soils exist, an infiltration test must be performed to determine the feasibility of an infiltration practice. Infiltration must be implemented if all of the following apply:
  - i. There is sufficient space to construct an infiltration trench with a bottom surface area of at least 100 square feet.
  - ii. There is sufficient CDA, BMP capacity, and saturated hydraulic conductivity, and BMP capacity to retain at least 100 cubic feet of runoff in the 1.7-inch rainfall event.
  - iii. The field-measured saturated hydraulic conductivity allows complete drawdown of the practice within 72 hours.
  - iv. Implementation of the infiltration practice will not negatively impact the proposed use of the developed area.
- b. Enhanced Bioretention. Enhanced bioretention need only be considered in NRCS Type A or B soils. Where Type A or B soils exist, an infiltration test must be performed to determine the feasibility of enhanced bioretention. Enhanced bioretention must be implemented if all of the following apply:
  - i. There is sufficient space to construct an enhanced bioretention area with a bottom surface area of at least 100 square feet.
  - ii. There is sufficient CDA, BMP capacity, and saturated hydraulic conductivity to retain at least 100 cubic feet of runoff in the 1.7-inch rainfall event.
  - iii. The field-measured saturated hydraulic conductivity allows complete drawdown of the infiltration sump within 72 hours.
  - iv. There is a suitable outlet for the underdrain on the property and within 100 feet of the proposed bioretention area.

- v. Implementation of the enhanced bioretention practice will not negatively impact the proposed use of the developed area.
- c. Standard Bioretention. Standard bioretention (with capped underdrain, as described in Appendix B - Maximum Extent Practicable Process for Existing Public Right-of-Way) must be implemented if all of the following apply:
  - i. There is sufficient space to construct a bioretention area with a bottom surface area of at least 100 square feet.
  - ii. There is sufficient CDA and BMP capacity to retain at least 100 cubic feet of runoff in the 1.7-inch rainfall event.
  - iii. There is a suitable outlet for the underdrain on the property and within 100 feet of the proposed bioretention area.
  - iv. Implementation of the bioretention area will not negatively impact the proposed use of the developed area.
- d. Impervious Surface Disconnection. Disconnection of the impervious surface must be implemented for portions of the LOD where both the following apply:
  - i. An increase in the LOD is not required to meet the feasibility requirements for the disconnection area.
  - ii. Implementation of the disconnection will not negatively impact the proposed use of the developed area.
- e. Tree Planting and Preservation. Tree planting or preservation must be implemented within the LOD where implementation will not negatively impact the proposed use of the developed area.

### **C.3 Plan review process and approval**

- a. In the site's topographic plan, show the preliminary development design and potential BMP locations.
- b. Calculate the required SWRv and retention volume that will be achieved by the proposed design.
- c. Complete the Practicable Determination Memo, describing the project objective and the applicable constraints for each BMP. For each type of BMP, describe conditions that limit their feasibility, if applicable.
- d. Meet with plan reviewer to discuss preliminary plan and ultimately achieve concurrence regarding the Practicable determination.
  - i. Meeting with plan reviewer should happen early in the design process, preferably no later than the 30% design development phase.
  - ii. Multiple meetings may be required to achieve concurrence, particularly as comments are addressed from other agencies or disciplines which impact the stormwater management plan. Concurrence regarding the Practicable determination will be granted once all other agency comments have been addressed which impact the stormwater management plan.

- e. Submit Stormwater Management Plan (SWMP) with updated Practicable Determination Memo for final review and approval.

<b>Practicable Determination Memo</b>	
<b>Project Description</b>  <b>Check all that apply:</b> <input type="checkbox"/> Affordable Houses <input type="checkbox"/> Pedestrian Trails <input type="checkbox"/> Small Structures at Parks	
<b>Total Disturbed Area</b>	<b>Proposed Natural Cover:</b>
	<b>Proposed Compacted Cover:</b>
	<b>Proposed Impervious Cover:</b>
	<b>Proposed BMP Area:</b>
	<b>Total:</b>
<b>SWR<sub>v</sub></b>	
<b>Retention Volume Achieved</b>	
<b>BMPs Implemented and Applicable Constraints</b>	
<b>BMP Practice</b>	<b>Justification</b>
<b>Infiltration</b>	
<b>Enhanced Bioretention</b>	
<b>Standard Bioretention</b>	
<b>Impervious Surface Disconnection</b>	
<b>Tree Preservation</b>	

<b>Tree Planting</b>	
----------------------	--





# Appendix D Off-Site Retention Forms for Regulated Sites

A site may comply with its Off-Site Retention Volume (Offv) by using Stormwater Retention Credits (SRCs), paying In-Lieu Fee (ILF), or through a combination of SRCs and ILF. The annual obligation to meet the site's Offv is described in Chapter 6, "Use of Off-Site Retention by Regulated Sites." Use the following forms to meet Offv:


- Application to Use Stormwater Retention Credits for Off-Site Retention Volume
- Notification of In-Lieu Fee Payment to Meet Off-Site Retention Volume

Applicants must submit Offv forms through the Stormwater Database at <https://doee.dc.gov/swdb>. Paper forms are also available in this appendix for reference (see Figures D.1 and D.2).

When submitting a notification of ILF payment, mail a check payable to the DC Treasurer to the following address and indicate the Stormwater Management Plan Number on the memo line, unless DOEE approves an alternate form of payment.

Regulatory Review Division / Offv  
Department of Energy and Environment  
1200 First Street NE, 5th Floor  
Washington, DC 20002

**GOVERNMENT OF THE DISTRICT OF COLUMBIA**  
 Department of Energy and Environment



**Application to Use Stormwater Retention Credits  
 for Off-Site Retention Volume**

**Acronyms**

<p><b>DOEE</b> Department of Energy and Environment  <b>GI</b> Green Infrastructure  <b>CSS</b> Combined Sewer System  <b>CSO</b> Combine Sewer Overflow  <b>AWDZ</b> Anacostia Waterfront Development Zone  <b>ILF</b> In-Lieu Fee</p>	<p><b>SRC</b> Stormwater Retention Credit  <b>MS4</b> Municipal Separate Storm Sewer System  <b>Offv</b> Off-Site Retention Volume  <b>SWMP</b> Stormwater Management Plan  <b>SWRv</b> Stormwater Retention Volume</p>
---	---

**Application date:** \_\_\_\_\_

**Address of regulated site for which SRC use is proposed:**

\_\_\_\_\_

Lot: \_\_\_\_\_ Square: \_\_\_\_\_ Ward: \_\_\_\_\_

**Storm Sewer System (MS4, CSS where CSOs will be reduced with GI, CSS where CSOs will be reduced with storage tunnels):** \_\_\_\_\_

**Is the site an AWDZ site (Yes or No)?** \_\_\_\_\_

**Name of site owner:** \_\_\_\_\_

Address: \_\_\_\_\_

E-Mail: \_\_\_\_\_ Phone: \_\_\_\_\_

**Name of owner's agent (if applicable):** \_\_\_\_\_

Address: \_\_\_\_\_

E-Mail: \_\_\_\_\_ Phone: \_\_\_\_\_

Information from DOEE-Approved SWMP for Regulated Site	
SWMP Number	
SWRv	
On-site retention volume achieved	
Offv	
Was at least 50% of the SWRv generated on site? (Yes or No)	

**Figure D.1 Application to Use Stormwater Retention Credits for Off-Site Retention Volume.**

Offv to be met with SRCs (number of gallons): \_\_\_\_\_

Offv to be met with payment of ILF (number of gallons): \_\_\_\_\_

**SRCs proposed for use** (Attach additional sheet if necessary):

Applicants must submit a completed application at least four (4) weeks before the proposed usage date. The obligation to use off-site retention to achieve Offv begins on the date of successful completion of the final construction inspection. Offv will be met on an annual basis following the final construction inspection.

Starting date for use (Indicate date or "as of final inspection." Multiple dates may be listed.)	Serial numbers (May indicate as range, where appropriate)

**Applicant's Signature**

A. Owner of regulated property: I hereby certify that I am the owner of the regulated property and of the SRCs proposed for use herein and that this application is correct to the best of my knowledge.

Signature of Owner:

Date:

B. Agent: I hereby certify that I have the authority of the regulated property owner to make this application. The owner has assured me that he/she owns the SRCs proposed for use herein. I declare that this application is correct to the best of my knowledge.

Signature of Agent:

Date:

<b>FOR DEPARTMENT USE ONLY</b>		
Approved:	Approved in part:	Disapproved:
Signature:		Date:
Notes:		

Figure D.1 (continued)

**Instructions for Application to Use Stormwater Retention Credits  
for Off-Site Retention Volume**

Purpose of form: This form provides DOEE with the necessary information to track compliance with an Offv by use of SRCs.

NOTE: Buyers, sellers, or their agents must complete an Application for Transfer of Stormwater Retention Credit Ownership before SRCs may be used to satisfy an Offv requirement.

**Instructions**

**Application date:** Enter the date that the applicant completes the application.

**Address of regulated site for which SRC use is proposed:** Enter the street address for the regulated site that is applying to use SRCs to meet an Offv requirement. Lot, square, and ward information is available from the building permit and the approved SWMP for the site.

**Storm Sewer System (MS4, CSS targeted for GI, CSS with storage tunnels):** Choose one of the listed options. Sites in the MS4 must have SRCs generated in the MS4. If a site in the CSS achieves at least 50% of the SWRv on site, then the SRCs needed can be generated anywhere in the District. If a site in the CSS achieves less than 50% of the SWRv on site, then the following applies: sites in the CSS targeted for green infrastructure (GI) implementation must have SRCs generated either in the MS4 or in the CSS targeted for GI implementation; sites in the CSS with storage tunnels must have SRCs generated in the MS4.

**Is the site an AWDZ site (Yes or No)?** Select “yes” or “no”. AWDZ sites using SRCs generated outside of the Anacostia River watershed must use SRCs at a 1.25:1 ratio.

**Name of site owner:** Enter the name of the site owner. Also provide the site owner’s contact information.

**Name of owner’s agent:** If applicable, enter the name of a representative whom the owner has charged with achieving the Offv.

**Information from DOEE-approved SWMP for regulated site:** Enter information from the SWMP including the Plan’s tracking number, total required SWRv in gallons, on-site volume achieved, and required Offv. Indicate if the site achieved at least 50% of the SWRv on site.

**Offv to be met with SRCs:** Enter the number of gallons of the Offv requirement that a site owner seeks to achieve through SRCs. AWDZ sites using SRCs generated outside of the Anacostia River watershed must use SRCs at a 1.25:1 ratio.

**Offv to be met with payment of ILF:** Enter the number of gallons of the Offv to be achieved through payment of the ILF. To use an ILF payment for compliance, sites must also submit a Notification of In-Lieu Fee Payment to Meet Off-Site Retention Volume.

**SRCs proposed for use:** Enter the effective date when SRCs will be used to satisfy an Offv requirement. List the serial numbers of purchased SRCs.

Figure D.1 (continued)

**GOVERNMENT OF THE DISTRICT OF COLUMBIA**  
 Department of Energy and Environment



**Notification of In-Lieu Fee Payment to Meet  
 Off-Site Retention Volume**

**Acronyms**

<b>DOEE</b> Department of Energy and Environment	<b>SRC</b> Stormwater Retention Credit
<b>ILF</b> In-Lieu Fee	<b>Offv</b> Off-Site Retention Volume
<b>AWDZ</b> Anacostia Waterfront Development Zone	<b>SWMP</b> Stormwater Management Plan
<b>CSS</b> Combined Sewer System	<b>SWRv</b> Stormwater Retention Volume
<b>MS4</b> Municipal Separate Storm Sewer System	

**Application date:** \_\_\_\_\_

**Address of regulated site for which ILF use is proposed:**

\_\_\_\_\_

Lot: \_\_\_\_\_ Square: \_\_\_\_\_ Ward: \_\_\_\_\_ Storm Sewer System (CSS or MS4): \_\_\_\_\_

**Is the site an AWDZ site (Yes or No)?** \_\_\_\_\_

**Name of site owner:** \_\_\_\_\_

Address: \_\_\_\_\_

E-Mail: \_\_\_\_\_ Phone: \_\_\_\_\_

**Name of owner's agent (if applicable):** \_\_\_\_\_

Address: \_\_\_\_\_

E-Mail: \_\_\_\_\_ Phone: \_\_\_\_\_

Information from DOEE-Approved SWMP for Regulated Site	
SWMP Number	
SWRv	
On-site retention volume achieved	
Offv	

**Figure D.2 Notification of In-Lieu Fee Payment to Meet Off-Site Retention Volume.**

Offv to be met with SRCs (number of gallons): \_\_\_\_\_

Offv to be met with payment of ILF (number of gallons): \_\_\_\_\_

Proposed use of ILF (attach additional sheet if necessary).

Starting Date For Use (Indicate date or "as of final inspection." Multiple years may be listed.)	Total Payment

**Applicant's Signature**

A. Owner of regulated property: I hereby certify that I am the owner of the regulated property and that this application is correct to the best of my knowledge.

Signature of Owner:

Date:

B. Agent: I hereby certify that I have the authority of the regulated property owner to make this application. I declare that this application is correct to the best of my knowledge.

Signature of Agent:

Date:

<b>FOR DEPARTMENT USE ONLY</b>		
Payment Received:	Payment Received in Part:	Payment Not Received:
Signature:		Date:
Notes:		

**Figure D.2 (continued)**

**Instructions for Notification of In-Lieu Fee Payment to Meet  
Off-Site Retention Volume**

Purpose of form: This form provides DOEE with the necessary information to track compliance with an Offv by use of ILF.

**Instructions**

**Application date:** Enter the date that the applicant completes the application.

**Address of regulated site for which ILF is proposed:** Enter the street address for the regulated site that seeks to make an ILF payment to meet an Offv. Lot, Square, Ward, and Storm Sewer System information is available from the building permit and the approved SWMP for the site.

**Is the site an AWDZ site (Yes or No)?** Select “yes” or “no”. AWDZ sites must purchase SRCs generated outside of the Anacostia River watershed at a 1.25:1 ratio.

**Name of site owner:** Enter the name of the site owner. Also provide the site owner’s contact information.

**Name of owner’s agent:** If applicable, enter the name of a representative whom the owner has charged with achieving the Offv.

**Information from DOEE-Approved SWMP for regulated site:** Enter information from the SWMP including the Plan’s tracking number, total required SWRv in gallons, on-site volume achieved, and required Offv.

**Offv to be met with SRCs:** Enter the number of gallons of the Offv requirement that a site owner seeks to achieve through SRCs. AWDZ sites using SRCs generated outside of the Anacostia River watershed must use SRCs at a 1.25:1 ratio. To use SRCs for compliance, sites must also submit an Application to Use Stormwater Retention Credits for Off-Site Retention Volume.

**Offv to be met with payment of in-lieu fee:** Enter the number of gallons of the Offv that a site owner seeks to achieve through payment of the ILF.

**Proposed use of in-lieu fee:** Enter the effective date when in-lieu fee will be used to satisfy an Offv requirement.

In addition to the notification of ILF payment, please send a check made out to the DC Treasurer to:

Regulatory Review Division/Offv  
Department of Energy and Environment  
1200 First Street NE, 5th Floor  
Washington, DC 20002

Page 3 of 3

Figure D.2 (continued)






## **Appendix E Stormwater Retention Credit Forms (Certification, Trading, and Retirement)**

Use the following forms to certify, transfer, and retire Stormwater Retention Credits (SRCs):

- Application for Certification of Stormwater Retention Credits
- Application for Transfer of Stormwater Retention Credit Ownership
- Application to Retire Stormwater Retention Credits

Applicants must submit forms through the Stormwater Database at <https://doee.dc.gov/swdb>. Paper forms are also available in this appendix for reference (see Figures E.1 through E.3).

**GOVERNMENT OF THE DISTRICT OF COLUMBIA**  
Department of Energy and Environment



**Application for Certification of Stormwater Retention Credits**

**Acronyms**

<b>DOEE</b>	Department of Energy and Environment	<b>GI</b>	Green Infrastructure
<b>BMP</b>	Best Management Practice	<b>SRC</b>	Stormwater Retention Credit
<b>CSS</b>	Combined Sewer System	<b>MS4</b>	Municipal Separate Storm Sewer System
<b>CSO</b>	Combined Sewer Overflow	<b>SWMP</b>	Stormwater Management Plan

**Application date:** \_\_\_\_\_

**Address of site with eligible retention capacity:**  
\_\_\_\_\_

Lot: \_\_\_\_\_ Square: \_\_\_\_\_ Ward: \_\_\_\_\_

**Storm Sewer System (MS4, CSS where CSOs will be reduced with GI, CSS where CSOs will be reduced with storage tunnels):** \_\_\_\_\_

**Name of owner of proposed SRCs:** \_\_\_\_\_

Address: \_\_\_\_\_

E-Mail: \_\_\_\_\_ Phone: \_\_\_\_\_

**Name of site owner (if different from proposed SRC owner):**  
\_\_\_\_\_

Address: \_\_\_\_\_

E-Mail: \_\_\_\_\_ Phone: \_\_\_\_\_

**Name of owner of retention capacity (if different from site owner):**  
\_\_\_\_\_

Address: \_\_\_\_\_

E-Mail: \_\_\_\_\_ Phone: \_\_\_\_\_

**Figure E.1 Application for Certification of Stormwater Retention Credits**

Name of agent for owner of proposed SRCs (if applicable): \_\_\_\_\_

Address: \_\_\_\_\_

E-Mail: \_\_\_\_\_ Phone: \_\_\_\_\_

DOEE SWMP Number: \_\_\_\_\_

BMP ID Numbers for which SRCs are requested:

\_\_\_\_\_

SRC-eligible retention capacity for each BMP or land cover for which SRCs are requested:

\_\_\_\_\_

Has DOEE previously certified SRCs for the retention capacity (Yes or No)? \_\_\_\_\_

If no, attach the following:

- As-built SWMP, including site plan showing pre-project site conditions and retention as submitted and approved in the Stormwater Database.
- Signed maintenance contract or documentation of capacity and expertise to conduct maintenance for the time period for which SRCs are requested.

If yes, attach the following:

- Signed maintenance contract or documentation of capacity and expertise to conduct maintenance for the time period for which SRCs are requested.

What is the period for which SRCs are requested (circle an option): 1 year / 2 years / 3 years

Should DOEE list these SRCs and corresponding name and contact information in DOEE's SRC registry (Indicate Yes or No and, if yes, who should be listed):

\_\_\_\_\_

What is the asking price for each SRC? (optional) \_\_\_\_\_

Page 2 of 5

Figure E.1 (continued)

**Applicant's Signature**

A. Proposed SRC Owner: I hereby certify that I have the legal right to the SRCs proposed for certification above; that the application, including supporting documentation, is complete and correct to the best of my knowledge; that access will be provided for DOEE inspections; that the retention capacity will be maintained in accordance with the maintenance plan for the period for which SRCs are requested; that, if the retention capacity is not maintained, I will, for the volume from the period of failed maintenance, forfeit the SRCs, purchase replacement SRCs, or pay in-lieu fee to DOEE; and that, if during the period of time for which an SRC is certified, the property is sold or otherwise transferred to another person, the owner of the property on which the BMP or land cover is located will notify DOEE.

Signature of Proposed SRC Owner:

Date:

B. Agent: I hereby certify that I have the authority of the proposed SRC owner to make this application and that the application and plans are complete and correct to the best of my knowledge. The owner has assured me that access will be provided for DOEE inspections and that the retention capacity will be maintained in accordance with the maintenance plan for the period for which SRCs are requested. If the retention capacity is not maintained in good working order, the proposed SRC owner has assured me that, for the volume from the period of failed maintenance, the proposed SRC owner will forfeit the SRCs, purchase replacement SRCs, or pay in-lieu fee to DOEE. Finally, the proposed SRC owner has assured me that, if during the period of time for which an SRC is certified, the property is sold or otherwise transferred to another person, the owner of the property on which the BMP or land cover is located will notify the Department.

Signature of Agent:

Date:

<b>FOR DEPARTMENT USE ONLY</b>		
Approved:	Approved in part:	Disapproved:
Signature:		Date:
Total SRCs certified:	Total time period for which SRCs are certified:	
SRCs certified year 1:	Serial numbers:	
SRCs certified year 2:	Serial numbers:	
SRCs certified year 3:	Serial numbers:	
Notes:		

**Figure E.1 (continued)**

**Instructions for Application for Certification of Stormwater Retention Credits**

Purpose of form: This form provides DOEE with the necessary information to certify SRCs.

NOTE: Buyers, sellers, or their agents must complete an Application for Transfer of Stormwater Retention Credit Ownership before an SRC transaction may occur.

**Instructions**

**Application date:** Enter the date that the applicant completes the application.

**Address of site with eligible retention capacity:** Enter the street address for the site with retention capacity that complies with the eligibility requirements for SRC certification. Lot, square, and ward information is available from the building permit and the approved SWMP for the site.

**Storm Sewer System (MS4, CSS where CSOs will be reduced with GI, CSS where CSOs will be reduced with storage tunnels):** Choose one of the listed options. Sites in the MS4 must have SRCs generated in the MS4. If a site in the CSS achieves at least 50% of the SWRv on site, then the SRCs needed can be generated anywhere in the District. If a site in the CSS achieves less than 50% of the SWRv on site, then the following applies: sites in the CSS where CSOs will be reduced with green infrastructure (GI) implementation must have SRCs generated either in the MS4 or in the CSS where CSOs will be reduced with GI implementation; sites in the CSS where CSOs will be reduced storage tunnels must have SRCs generated in the MS4.

**Name of owner of proposed SRCs:** Enter the name and contact information for the person proposed as the owner of the SRCs. Once DOEE certifies the SRCs, this person will become the original SRC owner, with associated maintenance obligation. This person, or their agent, signs the application form. Once SRCs are certified or the agent signs the application, DOEE will notify the proposed SRC owner of its determination for the application. DOEE will list the original SRC owner (or the owner's agent) and contact information in a public registry posted to the DOEE website.

**Name of site owner:** If different from the proposed SRC owner, enter the name and contact information for the person who owns the site where BMPs are installed to generate SRCs. DOEE recognizes that a site owner could assign the right to the SRCs to an SRC aggregator or other person. In such a case, the SRC aggregator or other person may be the proposed SRC owner.

**Name of owner of retention capacity:** If different from site owner, enter the name and contact information for the owner of the retention capacity generating SRCs on a site. DOEE expects that, typically, the site owner would also be the owner of the retention capacity, but this may not always be the case.

Figure E.1 (continued)

**Name of agent for owner of proposed SRCs (if applicable):** Enter the name and contact information for a person who is authorized to represent the proposed SRC owner in applying for certification of SRCs. If the agent is also authorized to represent (and take the place of) the proposed SRC owner in DOEE's SRC registry as the contact for interested SRC buyers, that should be indicated.

**DOEE SWMP Number:** Enter the tracking number assigned to the SWMP by DOEE.

**Identification number(s) for each BMP for which SRCs are requested:** Enter the tracking number for the BMP, as identified in the SWMP. This will allow DOEE to identify the specific BMP on a site for which SRCs are being requested and for which maintenance will be required. Some sites may have multiple BMPs.

**SRC-eligible retention capacity for each BMP or land cover for which SRCs are requested:** Enter the SRC-eligible volume, as identified in the as-built SWMP for a site. For a site with one SRC-eligible BMP or land cover, this will typically correspond to cell B:50 of the SRC calculator.

**Has DOEE previously certified SRCs for the retention capacity?** Select "yes" or "no". DOEE certifies up to three years' worth of SRCs at one time. If the retention capacity is maintained and the BMP continues to function properly, applicants may apply for additional SRCs after the initial certification term is complete.

**What is the period for which SRCs are requested?** Select the number of years for which SRCs are requested. DOEE may certify up to three years' worth of SRCs at one time, but applicants should apply for fewer years if they do not intend to maintain the retention capacity for the entire three-year time period.

**Should DOEE list these SRCs and corresponding name and contact information in the SRC Registry?** Indicate whether the proposed SRC owner or the owner's agent would like the SRCs to be listed in the SRC Registry. Also indicate whether contact information for the owner or agent should be listed.

**What is the asking price for each SRC? (optional)** If the applicant would like DOEE to include an SRC price in the SRC registry, indicate that here. This is not binding, and the final price will be determined by the SRC seller and buyer.

Figure E.1 (continued)

**GOVERNMENT OF THE DISTRICT OF COLUMBIA**  
Department of Energy and Environment



**Application for Transfer  
of Stormwater Retention Credit Ownership**

**Acronyms**

**DOEE** Department of Energy and Environment

**SRC** Stormwater Retention Credit

**Application date:** \_\_\_\_\_

**Number of SRCs to transfer:** \_\_\_\_\_

**Serial numbers of SRCs (may be listed as a range):**

**Purchase price for SRCs:** \_\_\_\_\_

**Name of current owner of SRCs:** \_\_\_\_\_

**Address** \_\_\_\_\_

**E-Mail:** \_\_\_\_\_ **Phone:** \_\_\_\_\_

**Name of new owner of SRCs:** \_\_\_\_\_

**Address:** \_\_\_\_\_

**E-Mail:** \_\_\_\_\_ **Phone:** \_\_\_\_\_

**Name of agent for new owner of SRCs (if applicable):**

\_\_\_\_\_

**Address:** \_\_\_\_\_

**E-Mail:** \_\_\_\_\_ **Phone:** \_\_\_\_\_

**Figure E.2 Application for Transfer of Stormwater Retention Credit Ownership.**

Should DOEE list these SRCs and the name and contact information for the owner or owner's agent in DOEE's SRC registry? (Indicate Yes or No and, if yes, who should be listed)

---

**Signature of Current Owner**

I hereby certify that I am the owner of the above SRCs; that I request the ownership of these SRCs to be transferred as stated above; and that this application is complete and correct to the best of my knowledge.

Signature:

Date:

<b>FOR DEPARTMENT USE ONLY</b>		
Approved:	Approved in part:	Disapproved:
Signature:		Date:
Notes:		

**Figure E.2 (continued)**



**Instructions for Application for Transfer  
of Stormwater Retention Credit Ownership**

Purpose of form: This form provides DOEE with the necessary information to verify and track ownership of SRCs and the price at which SRCs are traded.

**Instructions**

**Application date:** Enter the date that the applicant completes the application.

**Number of SRCs to transfer:** Enter the number of SRCs that are proposed for transfer from a seller to buyer.

**Serial numbers of SRCs (may be listed as a range):** Enter the serial numbers for SRCs to be transferred. Individually list serial numbers for SRCs that are not in sequential order. Use a range for sequential SRCs.

**Purchase price for SRCs:** Enter the price for each SRC to be transferred. If prices vary for different SRCs being transferred, enter each of the prices and the corresponding SRCs. DOEE will share price information on its website.

**Name of current owner of SRCs:** Enter the name and contact information for the current owner of SRCs to be transferred to the new owner.


**Name of new owner of SRCs:** Enter the name and contact information for the person to whom the SRCs will be transferred. DOEE will list the new owner on its SRC registry, unless the new owner requests not to be listed.

**Name of agent for new owner:** If applicable, enter the name and contact information for the agent of the new owner.

**Should DOEE list these SRCs and the new owner's name and contact information in DOEE's SRC registry?** Indicate whether the new SRC owner or the owner's agent would like the SRCs to be listed in DOEE's SRC registry. Also indicate whether the listed contact information should be for the new owner or the agent.

Figure E.2 (continued)

**GOVERNMENT OF THE DISTRICT OF COLUMBIA**  
 Department of Energy and Environment



**Application to Retire Stormwater Retention Credits**

**Acronyms**

DOEE Department of Energy and Environment    SRC Stormwater Retention Credit

**Application date:** \_\_\_\_\_

**Number of SRCs to retire:** \_\_\_\_\_

**Serial numbers of SRCs (may be listed as a range):**

**Name of current owner of SRCs:** \_\_\_\_\_

**Address:** \_\_\_\_\_

**E-Mail:** \_\_\_\_\_ **Phone:** \_\_\_\_\_

**Retired in honor of (optional):** Name: \_\_\_\_\_ E-Mail: \_\_\_\_\_

**Signature of SRC Owner**

I hereby certify that I am the owner of the above SRCs; that I request these SRCs to be retired; and that this application is complete and correct to the best of my knowledge.

**Signature:** \_\_\_\_\_ **Date:** \_\_\_\_\_

<b>FOR DEPARTMENT USE ONLY</b>		
Approved:	Approved in part:	Disapproved:
Signature:		Date:
Notes:		

**Figure E.3 Application to Retire Stormwater Retention Credits.**

**Instructions for Application to Retire Stormwater Retention Credits**

Purpose of form: This form provides DOEE with the necessary information to retire SRCs and track accordingly.

**Instructions**

**Application date:** Enter the date that the applicant completes the application.

**Number of SRCs to retire:** Enter the number of SRCs that are proposed for retirement.

**Serial numbers of SRCs (may be listed as a range):** Enter the serial numbers for SRCs to be retired. Individually list serial numbers for SRCs that are not in sequential order. Use a range for sequential SRCs.

**Name of current owner of SRCs:** Enter the name and contact information for the owner of the SRCs.

**Retired in honor of:** Enter the name of person being honored.

Figure E.3 (continued)



# Appendix F Relief from Extraordinarily Difficult Site Conditions

## F.1 Relief from Extraordinarily Difficult Site Conditions

Regulated development sites may request relief from extraordinarily difficult site conditions if they are unable to meet the performance requirements of the stormwater management regulations as described in Chapter 2 Minimum Control Requirements. This request is subject to DOEE review.

This process can be used to seek relief from the following:

- The requirement to achieve 50% of the Stormwater Retention Volume (SWR<sub>v</sub>) on-site for projects located in Combined Sewer System (CSS) areas where combined sewer overflows (CSOs) will be reduced with green infrastructure (GI);
- The requirement to achieve 50% of the SWR<sub>v</sub> on-site for projects located in the Municipal Separate Storm Sewer System (MS4);
- The requirement to retain or treat at least 50% of the SWR<sub>v</sub> from each site drainage area (SDA) for projects in the MS4; or
- The requirement to retain or treat at least 50% of the SWR<sub>v</sub> from the entire vehicular access area for each SDA for projects in the MS4.

There is no requirement to achieve 50% of the SWR<sub>v</sub> on-site for projects located in CSS areas where CSOs will be reduced with storage tunnels.

Note that major land-disturbing activities in the existing public right-of-way (PROW) use the maximum extent practicable (MEP) process detailed in Appendix B - Maximum Extent Practicable Process for Existing Public Right-of-Way to determine sizing criteria used to achieve the stormwater management performance requirements for regulated activity. These projects are not required to apply for relief from extraordinarily difficult site conditions. Regulated activity located in the Anacostia Waterfront Development Zone (AWDZ) that are governed by the Anacostia Waterfront Environmental Standards Amendment Act of 2012 (see D.C. Official Code §§ 2-1226.36(c)(1)) must have all off-site retention and all off-site Water Quality Treatment Volume (WQT<sub>v</sub>) approved by DOEE through the process defined in this appendix, even if the District-wide minimum 50% on-site retention requirement is met. All regulated development sites are required to address the SWR<sub>v</sub>, as described in Chapter 2 Minimum Control Requirements. All development sites in the AWDZ are required to address the WQT<sub>v</sub>, as described in Chapter 2, “Minimum Control Requirements.” If compliance with the minimum on-site retention or treatment requirements for the site, for individual SDAs, or for vehicular access areas, is technically infeasible or environmentally harmful, the applicant may apply for relief

from extraordinarily difficult site conditions. Additionally, if the regulated activity is in the AWDZ, consideration for a request for relief will include the limited appropriateness of on-site compliance in terms of impact on surrounding landowners or overall benefit to District waterbodies. In cases where an applicant claims extraordinarily difficult site conditions, it is the responsibility of the applicant to provide sufficient evidence to support the claim.

Once granted relief from extraordinarily difficult site conditions, an applicant is allowed to provide less than the minimum compliance requirements on-site by managing a greater retention volume or WQTV through off-site mitigation or provide less than the minimum compliance requirements in each SDA or vehicular access area by retaining or treating a greater volume in other areas of the site, up to the 1.7-inch rainfall event. Except for qualifying affordable housing projects, this process does not relieve the applicant from the obligation to manage the full SWRV or the WQTV determined through compliance calculations, but allows the applicant to satisfy a larger portion of these requirements off-site or in a different SDA. When DOEE finds the evidence presented is sufficient and compelling to grant relief, the Stormwater Management Plan (SWMP) for the project must identify the requirement for the use of off-site retention to offset the entire on-site retention deficit (if applicable).

## **F.2 Submission requirements for Relief from Extraordinarily Difficult Site Conditions**

A request for relief is made through a “relief request memo.” The memo is submitted in advance of a final SWMP, but not before the 65% design stage of the SWMP, with supporting evidence to demonstrate the claim of technical infeasibility or DCMR. The memo shall provide a detailed explanation of each opportunity for on-site installation of retention BMPs that was considered and rejected, and the reasons for each rejection. The applicant shall address each retention practice specified in this guidance manual in BMP groups 1 through 13, specifically,

BMP Group 1	Green Roofs
BMP Group 2	Rainwater Harvesting
BMP Group 3	Impermeable Surface Disconnection
BMP Group 4	Permeable Pavement Systems
BMP Group 5	Bioretention
BMP Group 7	Infiltration
BMP Group 8	Open Channel Systems
BMP Group 13	Tree Planting

Evidence of site conditions limiting each opportunity for a retention BMP include the following:

1. Data on soil and groundwater contamination;
2. Data from soils testing consistent with the geotechnical requirements in Appendix P - Geotechnical Information Requirements for Underground BMPs;
3. Documentation of the presence of utilities requiring impermeable protection or a setback;

4. Evidence of the applicability of a statute, regulation, court order, preexisting covenant, or other restriction having the force of law;
5. Evidence that the installation of a retention BMP would conflict with the terms of a non-expired approval, applied for prior to the end of Transition Period Two A for a major land-disturbing activity or before the end of Transition Period Two B for a major substantial improvement activity, of a:
  - (a) Concept review by the Historic Preservation Review Board;
  - (b) Concept review by the Commission on Fine Arts;
  - (c) Preliminary or final design submission by the National Capital Planning Commission;
  - (d) Variance or special exception from the Board of Zoning Adjustment; or
  - (e) Large Tract Review by the District Office of Planning; and
6. For a utility, evidence that a property owner on or under whose land the utility is conducting work objects to the installation of a BMP;
7. For a major substantial improvement activity, evidence that the structure cannot accommodate a BMP without significant alteration because of a lack of available interior or exterior space or limited load-bearing capacity; and

Projects in the AWDZ, governed by the Anacostia Waterfront Environmental Standards Amendment Act of 2012, may also discuss the limited appropriateness of on-site compliance verses a combination of off-site and on-site retention and or water quality treatment in terms of the impact on surrounding landowners or the overall benefit to District waterbodies.

### **F.3 Review of Requests for Relief from Extraordinarily Difficult Site Conditions**

In an application for Relief from Extraordinarily Difficult Site Conditions, a completed application and proof of payment of the applicable fee are required to begin the review of the request. DOEE cannot render a final decision until an application for relief is considered complete. However, if an application is substantially complete, DOEE may begin consideration of the request for relief. Upon accepting an application, DOEE will review and determine whether the application meets the requirements of this section, including the following:

1. Require additional information;
2. Grant relief;
3. Grant relief, with conditions;
4. Deny relief; or
5. Deny relief in part.

In determining whether to grant relief, DOEE may consider the following:

1. The applicant's submittal;

2. Other site-related information;
3. An alternative design;
4. DOEE's Stormwater Management Guidebook (SWMG);
5. Another BMP that meets the SWMG's approval requirements; and
6. Relevant scientific and technical literature, reports, guidance, and standards.



# Appendix G Stormwater Conveyance System Design

## G.1 Introduction

The focus of this guidebook is to define standards and specifications for design, construction, and maintenance of best management practices (BMPs) required to meet stormwater performance objectives. The components and considerations of the accompanying stormwater conveyance system are outlined in this appendix.

## G.2 Clearance with Other Utilities

- All proposed and existing utilities crossing or parallel to designed storm sewer systems must be shown on the plan and profile.
- Storm drain and utility crossings must not have less than a 45-degree angle between them.
- Minimum vertical and horizontal clearances, wall to wall, must be provided between storm drainage lines and other utilities as defined by the District of Columbia Water and Sewer Authority (DC Water). Consult DC Water's Project Design Manual and Green Infrastructure Utility Protection Guidelines, latest additions, for details. Exceptions may be granted by DC Water on a case-by-case basis when justified.

## G.3 Design of Stormwater Conveyance Systems

The Chezy-Manning formula is to be used to compute the system's transport capacities:

$$Q = \frac{1.486}{n} \times A \times R^{2/3} \times S^{1/2}$$

where:

- Q = channel flow (cfs)
- n = Manning's roughness coefficient (Table F.1)
- A = cross-sectional area of flow (ft<sup>2</sup>)
- R = hydraulic radius (ft) = A/P
- S = channel slope (ft/ft)
- P = wetted perimeter (ft)

**Table G.1 Manning’s Roughness Coefficient (n) Values for Various Channel Materials**

Channel Materials	Roughness Coefficient
Concrete pipe and precast culverts ≤ 24 inches in diameter	0.015
≥ 27 inches in diameter	0.013
Monolithic concrete in boxes, channels	0.015
Corrugated metal	0.022
PVC pipes	0.011
Sodded channel with water depth < 1.5 feet	0.050
Sodded channel with water depth >1.5 feet	0.035
Smooth earth channel or bottom of wide channels with sodded slopes	0.025
Riprap channels	0.035

Note: Where drainage systems are composed of more than one of the above channel materials, a composite roughness coefficient must be computed in proportion to the wetted perimeter of the different materials.

Also, the computation for the flow velocity of the channel must use the continuity equation as follows:

$$Q = A \times V$$

where:

- $V$  = velocity (ft/s)
- $A$  = cross-sectional area of the flow (ft<sup>2</sup>)

### G.4 Gutters

With uniform cross slope and composite gutter section use the following equation:

$$Q = \frac{0.50}{n} \times S_x^{1.67} \times S^{0.5} \times T^{2.67}$$

where:

- $Q$  = flow rate (cfs)
- $n$  = Manning’s roughness coefficient (Table F.1)
- $S_x$  = cross slope (ft/ft)
- $S$  = longitudinal slope (ft/ft)
- $T$  = width of flow (spread) (ft)

## G.5 Inlets

In accordance with the current requirements of the District of Columbia Plumbing Code, all inlets on private or public parcels, but outside the public right-of-way (PROW), must be sized to ensure safe conveyance of stormwater flows exceeding the capacity of the approved on-site stormwater management practices and the designated pervious land cover areas. These stormwater flows must not flow over property lines onto adjacent lots unless these flows run into an existing natural water course. Stormwater inlets in the PROW must be designed in accordance with the current requirements in Chapter 33 of the District of Columbia Department of Transportation (DDOT) Design and Engineering Manual and be approved for use by DC Water.

## G.6 Street Capacity (Spread)

Design of the conveyance of stormwater runoff within the PROW must follow the current requirements in the DDOT Design and Engineering Manual. The roadway drainage design criteria for existing streets is a 15-year storm, 5-minute duration, and a maximum spread of 6 feet from the face of the curb (32.3.13 DDOT Design and Engineering Manual 2009). Proposed streets must use AASHTO Chapter VI for their design criteria.

## G.7 Manhole and Inlet Energy Losses

The following formulas must be used to calculate headloss:

$$HL = \frac{V_{outlet}^2 - V_r^2}{2g} + SL$$

$$V_r = \frac{Q(V \cos \frac{a}{2})_{(inlet\ 1)} + Q(V \cos \frac{a}{2})_{(inlet\ 2)} + \dots}{Q_{(outlet)}}$$

where:

- $HL$  = head loss in the structure
- $V_{outlet}$  = outlet velocity
- $V_r$  = resultant velocity
- $g$  = gravitational acceleration (32.2 ft/s<sup>2</sup>)
- $SL$  = minimum structure loss
- $Q$  = flow rate (cfs)
- $a$  = angle between the inlet and outlet pipes (180°)

Table G.2 provides the minimum structure loss for inlets, manholes, and other inlet structures for use in the headloss calculation.

**Table G.2 Minimum Structure Loss to Use in Hydraulic Grade Line Calculation**

Velocity, $V_{outlet}$ (ft/s)*	Structure Loss, $SL$
2	0.00
3	0.05
4	0.10
5	0.15
6	0.20
6	0.25

\* Velocities leaving the structure.

Headloss at the field connection is to be calculated like those structures, eliminating the structure loss. For the angular loss coefficient,  $\cos(a/2)$  is assumed to be 1.

## G.8 Open Channels

- Calculations must be provided for all channels, streams, ditches, swales, etc., including a typical section of each reach and a plan view with reach locations. In the case of existing natural streams/swales, a field survey of the stream (swale) cross sections may be required prior to the final approval.
- The final designed channel must provide a 6-inch minimum freeboard above the designated water surface profile of the channel.
- If the base flow exists for a long period of time or velocities are more than 5 feet per second in earth and sodded channel linings, gabion or riprap protection must be provided at the intersection of the inverts and side slopes of the channels unless it can be demonstrated that the final bank and vegetation are sufficiently erosion-resistant to withstand the designed flows, and the channel will stay within the floodplain easement throughout the project life.
- Channel inverts and tops of bank are to be shown in plan and profile views.
- For a designed channel, a cross section view of each configuration must be shown.
- For proposed channels, a final grading plan must be provided.
- The limits of a recorded 100-year floodplain easement or surface water easement sufficient to convey the 100-year flow must be shown.
- The minimum 25-foot horizontal clearance between a residential structure and 100-year floodplain must be indicated in the plan.
- For designed channels, transition at the entrance and outfall is to be clearly shown on the site plan and profile views.

## G.9 Pipe Systems

- Individual stormwater traps must be installed on the storm drain branch serving each structural stormwater BMPs or a single trap must be installed in the main storm drain after it leaves the structural stormwater BMP and before it connects with the city’s combined sewer. Such traps must be provided with an accessible cleanout. The traps are not required for storm drains that are connected to a separate storm sewer system.
- The pipe sizes used for any part of the storm drainage system within the PROW must follow DC Water Standard and Specifications. The minimum pipe size to be used for any part of a private storm drainage system must follow the current requirements of the District of Columbia Plumbing Code.
- The material and installation of the storm drain for any part of public storm sewer must follow DC Water Standard and Specifications.
- An alternative overflow path for the 100-year storm is to be shown on the plan view if the path is not directly over the pipe. Where applicable, proposed grading must ensure that overflow will be into attenuation facilities designed to control the 100-year storm.
- A pipe schedule tabulating pipe lengths by diameter and class is to be included on the drawings. Public and private systems must be shown separately.
- Profiles of the proposed storm drains must indicate size, type, and class of pipe, percent grade, existing ground and proposed ground over the proposed system, and invert elevations at both ends of each pipe run. Pipe elevations and grades must be set to avoid hydrostatic surcharge during design conditions. Where hydrostatic surcharge greater than 1-foot of head cannot be avoided, a rubber gasket pipe is to be specified.

## G.10 Culverts

Culverts must be built at the lowest point to pass the water across embankment of pond or highway. Inlet structure must be designed to resist long-term erosion and increased hydraulic capacities of culverts. Outlet structures must be designed to protect outlets from future scouring. The following formulas are to be used in computing the culvert:

If the outlet is submerged, then the culvert discharge is controlled by the tail water elevation:

$$h = h_e + h_f + h_v$$

where:

- $h$  = head required to pass given quantity of water through culvert flowing in outlet control with barrel flowing full throughout its length
- $h_e$  = entrance loss
- $h_f$  = friction loss
- $h_v$  = velocity head

and:

$$h = k_e \left( \frac{V^2}{2g} \right) + \frac{n^2 V^2 L}{2.21 R^{\frac{4}{3}}} + \frac{V^2}{2g}$$

$$h = \left[ k_e + \frac{n^2 L}{2.21 R^{\frac{4}{3}}} \times 2g + 1 \right] \times \left( \frac{V^2}{2g} \right)$$

$$h = \left[ k_e + \frac{n^2 L}{2.21 R^{\frac{4}{3}}} \times 2g + 1 \right] \times \left( \frac{8Q^2}{9.87gD^4} \right)$$

where:

- $k_e$  = entrance loss coefficient = 0.5 for a square-edged entrance  
entrance loss coefficient = 0.1 for a well-rounded entrance
- $V$  = mean or average velocity in the culvert barrel (ft/s)
- $g$  = gravitational acceleration (32.2 ft/s<sup>2</sup>)
- $n$  = Manning's roughness coefficient = 0.012 for concrete pipe
- $L$  = length of culvert barrel (ft)
- $R$  = 0.25D = hydraulic radius (ft)
- $Q$  = flow (cfs)
- $D$  = diameter (ft)

If the normal depth of the culvert is larger than the barrel height, the culvert will flow into a full or partially full pipe. The culvert discharge is controlled by the entrance conditions or entrance control.

$$Q = C_d A (2gh)^{0.5}$$

where:

- $Q$  = discharge (cfs)
- $C_d$  = discharge coefficient = 0.62 for square-edged entrance  
discharge coefficient = 0.1 for well-rounded entrance
- $A$  = cross sectional area (ft<sup>2</sup>)
- $g$  = gravitational acceleration (32.2 ft/s<sup>2</sup>)
- $h$  = hydrostatic head above the center of the orifice (ft)

If the hydrostatic head is less than 1.2D, the culvert will flow under no pressure as an open channel system. If the flows are submerged at both ends of the culvert, use Figure F.1.

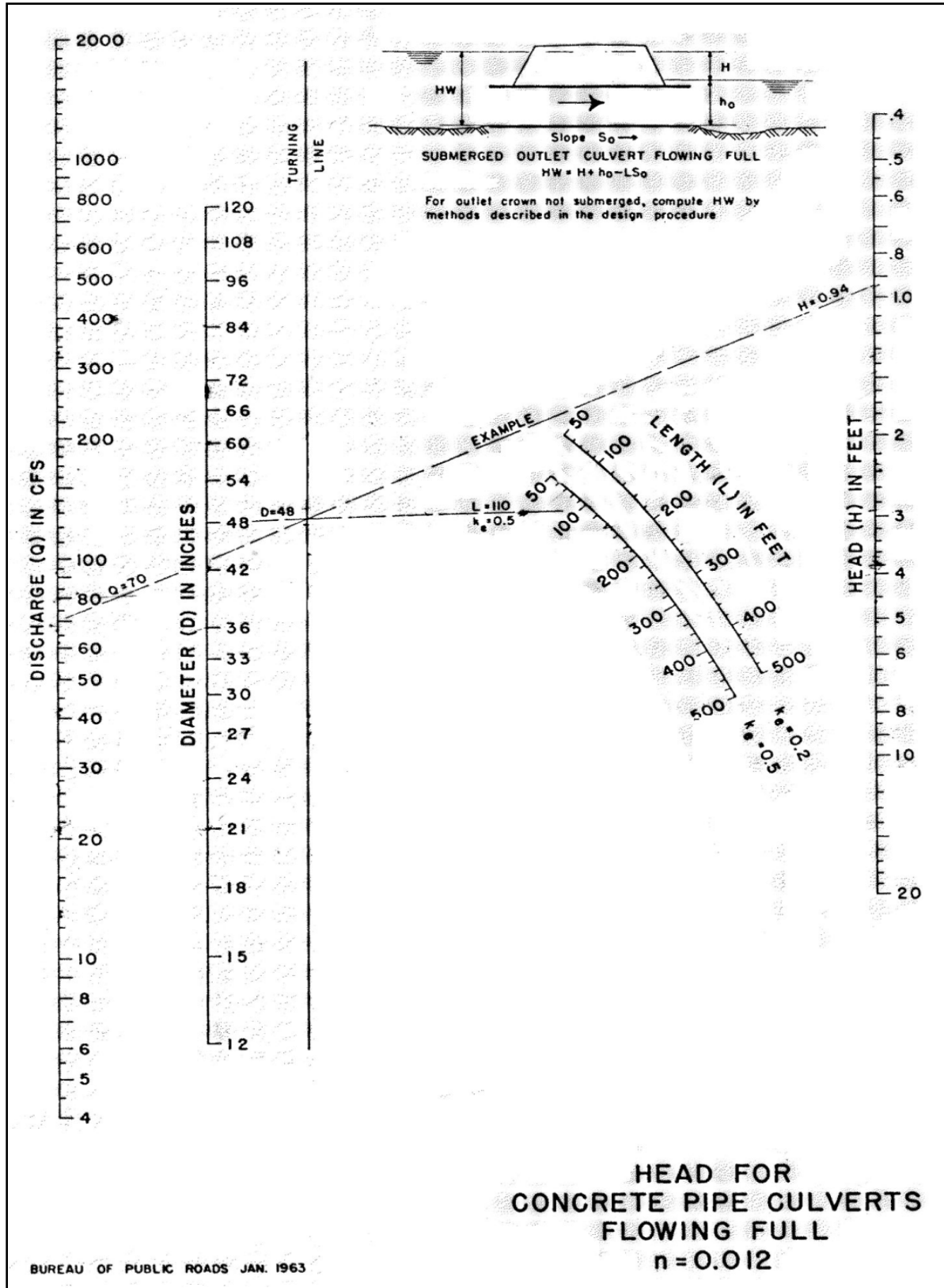


Figure G.1 Typical nomograph for culverts under outlet control.

## G.11 Hydraulic Grade Line

A hydraulic grade line (HGL) must be clearly indicated on the system profiles and identified with the initials HGL on the line and in the legend key. This HGL must take into consideration pipe and channel friction losses, computing structures losses, tail water conditions, and entrance losses. All pipe systems must be designed so that they will operate without building up a surcharged hydrostatic head under design flow conditions. It is recommended that the HGL be no more than 1 foot above the pipe crown. If pipes have an HGL more than 1 foot above the pipe crown, rubber gaskets are required.

If the structural stormwater BMP discharges into a storm sewer or a combined sewer system, a detailed HGL analysis of the system including the receiving system must be submitted with the final Stormwater Management Plans (SWMPs) for the 15- and 100-year flow frequencies. If the time characteristics of the HGL are unknown, the designed structural stormwater BMP must be functional under expected minimum and maximum grade lines.

## G.12 Manholes and Inlets

- DC Water Standards and Specifications must be used. All structures are to be numbered and listed in the structure schedule and must include type, standard detail number, size, top elevation, slot elevation and locations, and modification notes.
- Access structures must be spaced according to the DC Water Standards and Specifications and the DDOT Design and Engineering Manual.
- Where two or more pipes enter a structure, a minimum of 9 inches of undisturbed concrete between holes in precast concrete is required to ensure sufficient steel. Consult DC Water for more specifics.
- A minimum drop of 0.1 foot must be provided through the structure invert.
- Drainage boundary and contours must be shown around each inlet to ensure that positive drainage to the proposed inlet is provided.
- Invert elevations of the pipes entering and leaving the structures must be shown in the profile view.
- Yard or grate inlets must show the 15-year and 100-year ponding limits (if applicable). A depth of not more than 2 feet is allowed from the throat or grate to the 100-year storm elevation.
- Public street inlets must follow DC Water and DDOT criteria.
- Additional structures are recommended and may be required on steep slopes to reduce excessive pipe depths and/or to provide deliberate drops in the main line to facilitate safe conveyance to a proper outfall discharge point. In order to provide an outfall at a suitable slope (i.e., less than 5% slope), drop structures may need to be used to reduce the velocity before discharging on a riprap area.
- Curb inlets located on private cul-de-sacs must have a maximum 10 linear feet opening.



- For commercial/industrial areas, inlets must be kept at least 5 feet away from the driveway aprons.

The determination of the minimum width of a structure based on incoming pipes is based on the following formula:

$$W = \frac{D}{\sin \theta} + \frac{T}{\tan \theta}$$

where:

- $W$  = minimum structure width (inside)
- $D$  = pipe diameter (outside)
- $T$  = inlet wall thickness
- $\theta$  = angle of pipe entering structure



# Appendix H Design of Flow Control Structures

Flow control devices are orifices and weirs. The following formulas shall be used in computing maximum release rates from the designed structural best management practice (BMP).

## H.1 Circular Orifices

$$Q = CA(2gh)^{0.5}$$

where:

- $Q$  = orifice discharge (cfs)
- $C$  = discharge coefficient = 0.6
- $A$  = orifice cross-sectional area (ft<sup>2</sup>) =  $3.1416 \times \frac{D^2}{4}$
- $D$  = diameter of orifice (ft)
- $g$  = gravitational acceleration (32.2 ft/s<sup>2</sup>)
- $h$  = hydraulic head above the center of the orifice (ft)

When  $h < D$ , the orifice shall be treated as a weir:

$$Q = CLH^{3/2}$$

where:

- $Q$  = flow through the weir (cfs)
- $C$  = discharge coefficient = 3
- $L$  = diameter of orifice (ft)
- $H$  = hydraulic head above bottom of weir opening (ft)

## H.2 Weirs

Rectangular:

$$Q = 3.33H^{1.5}(L - 0.2H)$$

60° V-notch:

$$Q = 1.43H^{2.5}$$

90° V-notch:

$$Q = 2.49H^{2.48}$$

where:

- $Q$  = flow through the weir (cfs)
- $H$  = hydraulic head above the bottom of the weir (ft)
- $L$  = length of the weir crest (ft)

# Appendix I Acceptable Hydrologic Methods and Models

## I.1 Acceptable Hydrologic Methods and Models

The following are the acceptable methodologies and computer models for estimating runoff hydrographs before and after development. These methods are used to predict the runoff response from given rainfall information and site surface characteristic conditions. The design storm frequencies used in all of the hydrologic engineering calculations will be based on design storms required in this guidebook unless circumstances make consideration of another storm intensity criterion appropriate:

- Urban Hydrology for Small Watersheds TR-55 (TR-55)
- Storage-Indication Routing
- HEC-1, WinTR-55, TR-20, and SWMM Computer Models
- Rational Method (limited to sites under 5 acres)

These methods are given as valid in principle and are applicable to most stormwater management design situations in the District. Other methods may be used when the District reviewing authority approves their application.

Note: Of the above methods, TR-55 and SWMM allow for the easiest correlation of the benefits of retention best management practices (BMPs) used to meet the SWRV with peak flow detention requirements, and are therefore strongly recommended. The Rational Method is not recommended, as it cannot account for the detention benefits of smaller retention BMPs applied on a site. However, the Rational Method is useful for quickly and easily calculating peak flows and detention requirements. Appendix A - Compliance Calculations and Design Examples includes more information on using the General Retention Compliance Calculator and Stormwater Database to account for retention BMPs in calculating peak flow detention requirements.

The following conditions should be assumed when developing predevelopment, pre-project, and post-development hydrology, as applicable:

- Predevelopment runoff conditions (used for the 2-year storm) shall be computed independent of existing developed land uses and conditions and shall be based on “meadow in good condition” or better, assuming good hydrologic conditions and land with grass cover.
- Pre-project runoff conditions (used for the 15-year storm) shall be based on the existing condition of the site.
- Post-development conditions shall be computed for future land use assuming good hydrologic and appropriate land use conditions. If an NRCS CN Method-based approach,

such as TR-55, is used, this curve number (CN) may be reduced based upon the application of retention BMPs, as indicated in the General Retention Compliance Calculator and Stormwater Database (see Appendix A - Compliance Calculations and Design Examples). This CN reduction will reduce the required detention volume for a site, but it should not be used to reduce the size of conveyance infrastructure.

- The rainfall intensity - duration - frequency curve should be determined from the most recent version of the Hydrometeorological Design Studies Center's Precipitation Frequency Data Server (NOAA Atlas 14, Volume 2).
- Predevelopment time of concentration shall be based on the sum total of computed or estimated overland flow time and travel in natural swales, streams, creeks and rivers, but never less than 6 minutes.
- Post-development time of concentration shall be based on the sum total of the inlet time and travel time in improved channels or storm drains, but shall not be less than 6 minutes.
- Site drainage areas exceeding 25 acres that are heterogeneous with respect to land use, soils, CN or time of concentration shall require a separate hydrologic analysis for each sub-area.
- Hydrologic soil groups (HSGs) approved for use in the District are contained in the Soil Survey of the District of Columbia Handbook. Where the HSG is not available through the Soil Survey due to the listed soil type being "Urban Soils" or similar, an HSG of C shall be used.

## I.2 Urban Hydrology for Small Watersheds TR-55

Chapter 6 of Urban Hydrology for Small Watersheds TR-55, Storage Volume for Detention Basins, or TR-55 shortcut procedure, is based on average storage and routing effects for many structures and can be used for multistage outflow devices. Refer to TR-55 for more detailed discussions and limitations.

### Information Needed

To calculate the required storage volume using TR-55, the predevelopment hydrology for the 2-year storm and the pre-project hydrology for the 15-year storm are needed, along with post-development hydrology for both the 2-year and 15-year storms. The predevelopment hydrology for the 2-year storm is based on natural conditions (meadow) and will determine the site's predevelopment peak rate of discharge, or allowable release rate,  $q_{o2}$ , for the 2-year storm, whereas the pre-project hydrology for the 15-year storm is based on existing conditions and will determine the site's pre-project peak rate of discharge, or allowable release rate,  $q_{o15}$ , for the 15-year storm.

The post-development hydrology may be determined using the reduced CNs calculated in the General Retention Compliance Calculator and Stormwater Database (See Appendix A - Compliance Calculations and Design Examples) or more detailed routing calculations. This will determine the site's post-development peak rate of discharge, or inflow for both the 2-year and 15-year storms,  $q_{i2}$  and  $q_{i15}$ , respectively, and the site's post-developed runoff,  $Q_2$  and  $Q_{15}$ , in inches. Note that this method does not require a hydrograph. Once the above parameters are

known, the TR-55 Manual can be used to approximate the storage volume required for each design storm. The following procedure summarizes the TR-55 shortcut method for detention calculations in the District.

### **Procedure**

- 1.** Determine if detention is required. Detention rules apply to the site as a whole rather than the individual SDAs so to determine if detention is required, compare the curve numbers for the total site. If the post-development reduced curve number is greater than the predevelopment curve number, detention is required for the 2-year storm. If the post-development reduced curve number is greater than the pre-project curve number, detention is required for the 15-year storm.
- 2.** Determine the peak development inflows  $qi_2$  and  $qi_{15}$ , the runoff volumes  $Q_2$  and  $Q_{15}$ , and the allowable release rates  $qo_2$  and  $qo_{15}$ , from the hydrology for the appropriate design storm.
- 3.** Using the ratio of the allowable release rate,  $qo$ , to the peak developed inflow,  $qi$ , or  $qo/qi$ , for both the 2-year and 15-year design storms, use Figure I.1 (or Figure 6.1 in TR-55) to obtain the ratio of storage volume,  $Vs$ , to runoff volume,  $Vr$ , or  $Vs_2 / Vr_2$  and  $Vs_{15} / Vr_{15}$  for Type II storms.

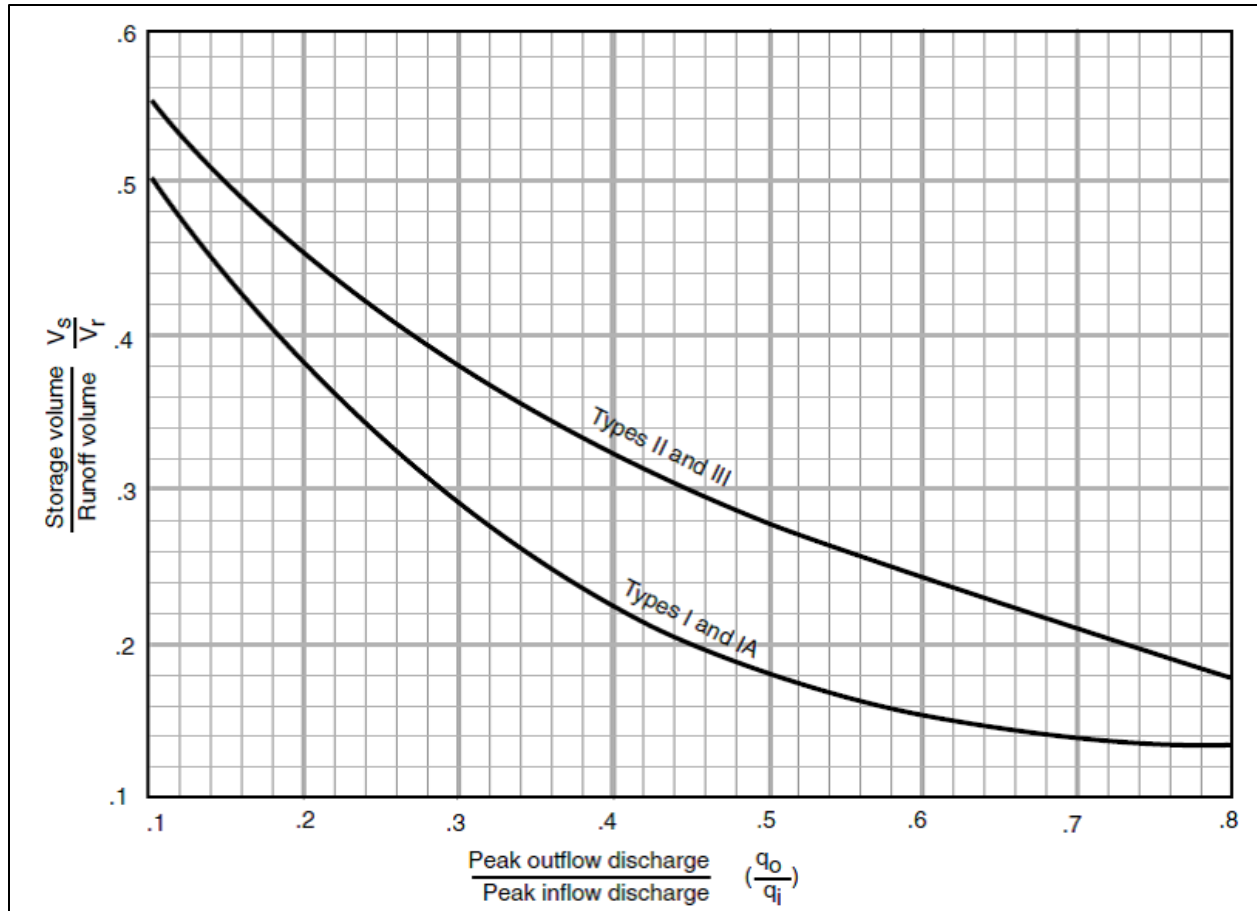


Figure I.1 Approximate detention basin routing for rainfall types I, IA, II and III.

4. Determine the runoff volumes,  $V_{r_2}$  and  $V_{r_{15}}$ .

$$V_{r_2} = \frac{Q_2}{12} \times SDA$$

where:

- $V_{r_2}$  = post-development runoff for the 2-year storm ( $\text{ft}^3$ )
- $Q_2$  = post-development runoff for the 2-year storm (in.)
- 12 = conversion factor from inches to feet
- $SDA$  = Site Drainage Area ( $\text{ft}^2$ )

$$V_{r_{15}} = \frac{Q_{15}}{12} \times SDA$$

where:

- $V_{r_{15}}$  = post-development runoff for the 15-year storm ( $\text{ft}^3$ )



- $Q_{15}$  = post-development runoff for the 15-year storm (in.)
- 12 = conversion factor from inches to feet
- $SDA$  = Site Drainage Area (ft<sup>2</sup>)

5. Multiply the  $V_s/V_r$  ratios from Step 1 by the runoff volumes,  $V_{r_2}$  and  $V_{r_{15}}$ , from Step 2, to determine the required storage volumes,  $V_{S_2}$  and  $V_{S_{15}}$ , in acre-feet.

$$\left(\frac{V_{S_2}}{V_{r_2}}\right)V_{r_2} = V_{S_2}$$

$$\left(\frac{V_{S_{15}}}{V_{r_{15}}}\right)V_{r_{15}} = V_{S_{15}}$$

Note: In most cases,  $V_{S_{15}}$  represents the total storage required for the 2-year storm and the 15-year storm, and the outflow,  $q_{o_{15}}$ , includes the outflow  $q_{o_2}$ . In some cases,  $V_{S_{15}}$  may be less than  $V_{S_2}$ . In these cases, the storage volume provided for the 2-year storm ( $V_{S_2}$ ) may or may not be sufficient to meet the 15-year requirements and must be checked via stage-storage curve analysis.

6. Design a storage practice that holds the required volume with one or more orifices or other outlet devices that limit the outflow to the allowable discharge rates for the 2-year and 15-year storms. See the orifice equation in Appendix H - Design of Flow Control Structures.

### Limitations

This routing method is less accurate as the  $q_o/q_i$  ratio approaches the limits shown in Figure I.1. The curves in Figure I.1 depend on the relationship between available storage, outflow device, inflow volume, and shape of the inflow hydrograph. When storage volume ( $V_s$ ) required is small, the shape of the outflow hydrograph is sensitive to the rate of the inflow hydrograph. Conversely, when  $V_s$  is large, the inflow hydrograph shape has little effect on the outflow hydrograph. In such instances, the outflow hydrograph is controlled by the hydraulics of the outflow device and the procedure therefore yields consistent results. When the peak outflow discharge ( $q_o$ ) approaches the peak inflow discharge ( $q_i$ ) parameters that affect the rate of rise of a hydrograph, such as rainfall volume, CN, and time of concentration, become especially significant.

The procedure should not be used to perform final design if an error in storage of 25% cannot be tolerated. Figure I.1 is biased to prevent undersizing of outflow devices, but it may significantly overestimate the required storage capacity. More detailed hydrograph development and storage indication routing will often pay for itself through reduced construction costs.

**Example 1a**

A 48,000 square foot development is proposed on Type C soils. SDA 1 will include a parking lot and a bioretention area (Figure I.2). SDA 2 will include a building and a green roof (Figure I.3). Predevelopment conditions on both SDAs yield a curve number of 70. In SDA 1, pre-project conditions include only turf cover, yielding a curve number of 74. Pre-project conditions in SDA 2 include both impervious and turf areas, yielding a curve number of 86. These values are indicated in Table I.1. Based on the proposed land covers and the implementation of the bioretention and green roof (which serve to reduce curve numbers), the post-development curve numbers are also indicated in Table I.1.



SDA 1 = 23,000 ft<sup>2</sup>  
 Post-Development CN (2-year/15-year)= 82/85

**Figure I.2 SDA 1 for Example 1a.**



SDA 2 = 25,000 ft<sup>2</sup>  
 Post-Development CN (2-year/15-year) = 71/78

**Figure I.3 SDA 2 for Example 1a.**

**Table I.1 Curve Numbers for Example 1a.**

	Area	Predevelopment Curve Number	2-Year Post-Development Curve Number <sup>1</sup>	Pre-Project Curve Number	15-Year Post-Development Curve Number <sup>1</sup>
SDA 1	23,000 ft <sup>2</sup>	70	82	74	85
SDA 2	25,000 ft <sup>2</sup>	70	71	86	78
<b>Total Site</b>	<b>48,000 ft<sup>2</sup></b>	<b>70</b>	<b>76</b>	<b>80</b>	<b>81</b>

1. These values incorporate the reductions achieved due to the implementation of the bioretention area and the green roof.

**Step 1: Determine if detention is required.**

For the total site, the 2-year post-development curve number of 76 is greater than the predevelopment curve number of 70, and the 15-year post-development curve number of 81 is greater than the pre-project curve number of 80. Therefore, detention will be needed for both the 2-year and 15-year storm.

**Step 2: Determine the peak development inflows  $qi_2$  and  $qi_{15}$  and the allowable release rates  $qo_2$  and  $qo_{15}$  from the hydrology for the appropriate design storm.**

There are several programs available for calculating peak flows and runoff hydrographs. The WinTR-55 program will be used in this example. The WinTR-55 program and support materials, including the User Guide can be found here:

<https://www.nrcs.usda.gov/wps/portal/nrcs/detailfull/national/water/?cid=stelprdb1042901>

Eight different model scenarios will be needed for this example, with the following inputs/characteristics (see Tables I.2 and I.3).

**Table I.2 SDA 1 TR-55 Model Scenarios for Example 1a.**

<b>Input</b>	<b>2- Year Predevelopment</b>	<b>2-Year Post-Development</b>	<b>15-Year Pre-Project</b>	<b>15-Year Post-Development</b>
Area	0.53 acre			
Curve Number	70	82	74	85
Time of Concentration <sup>1</sup>	0.1 hour			
Rainfall Depth <sup>2</sup>	3.14 inches	3.14 inches	5.23 inches	5.23 inches

**Table I.3 SDA 2 TR-55 Model Scenarios for Example 1a.**

<b>Input</b>	<b>2- Year Predevelopment</b>	<b>2-Year Post-Development</b>	<b>15-Year Pre-Project</b>	<b>15-Year Post-Development</b>
Area	0.57 acre			
Curve Number	70	71	86	78
Time of Concentration <sup>1</sup>	0.1 hour			
Rainfall Depth <sup>2</sup>	3.14 inches	3.14 inches	5.23 inches	5.23 inches

1. Actual drainage characteristics (flow lengths, slopes, etc.) shall be used, but the minimum Tc must be 6 minutes (0.1 hour).

2. The NRCS Type II Storm Event shall be used.

Using these inputs, WinTR-55 can produce peak flow rates and runoff volumes for the various scenarios (Tables I.4 and I.5).

**Table I.4 Example 1a Peak Flow Rates for SDA 1 and SDA 2.**

<b>SDA</b>	<b>2- Year Predevelopment Peak Flow (q<sub>02</sub>)</b>	<b>2-Year Post-Development Peak Flow (q<sub>i2</sub>)</b>	<b>15-Year Pre-Project Peak Flow (q<sub>015</sub>)</b>	<b>15-Year Post-Development Peak Flow (q<sub>i15</sub>)</b>
SDA 1	0.59 cfs	1.22 cfs	2.09 cfs	2.88 cfs
SDA 2	0.64 cfs	0.69 cfs	3.17 cfs	2.55 cfs

**Table I.5 Example 1a Runoff Volumes for SDA 1 and SDA 2.**

<b>SDA</b>	<b>2-Year Post-Development Runoff Volume (Q<sub>2</sub>)</b>	<b>15-Year Post-Development Runoff Volume (Q<sub>15</sub>)</b>
SDA 1	0.98 inch	3.00 inches
SDA 2	0.46 inch	2.41 inches

**Step 3:** Using the ratio of the allowable release rate  $q_0$  to the peak developed inflow  $q_i$ , or  $q_0/q_i$ , for both the 2-year and 15-year design storms, use Figure I.1 (or Figure 6.1 in TR-55) to obtain the ratio of storage volume  $V_s$  to runoff volume  $V_r$ , or  $V_{s2}/V_{r2}$  and  $V_{s15}/V_{r15}$  for Type II storms.

For SDA 1 (yellow lines on Figure I.4):

$$q_{02}/q_{i2} = 0.59/1.22 = 0.48$$

$$q_{015}/q_{i15} = 2.09/2.88 = 0.73$$

For SDA 2 (red line on Figure I.4):

$$q_{02}/q_{i2} = 0.64/0.69 = 0.93$$

$$q_{015}/q_{i15} = 3.17/2.55 = 1.24 \text{ (If } q_0/q_i \text{ is greater than 1, detention is not required)}$$

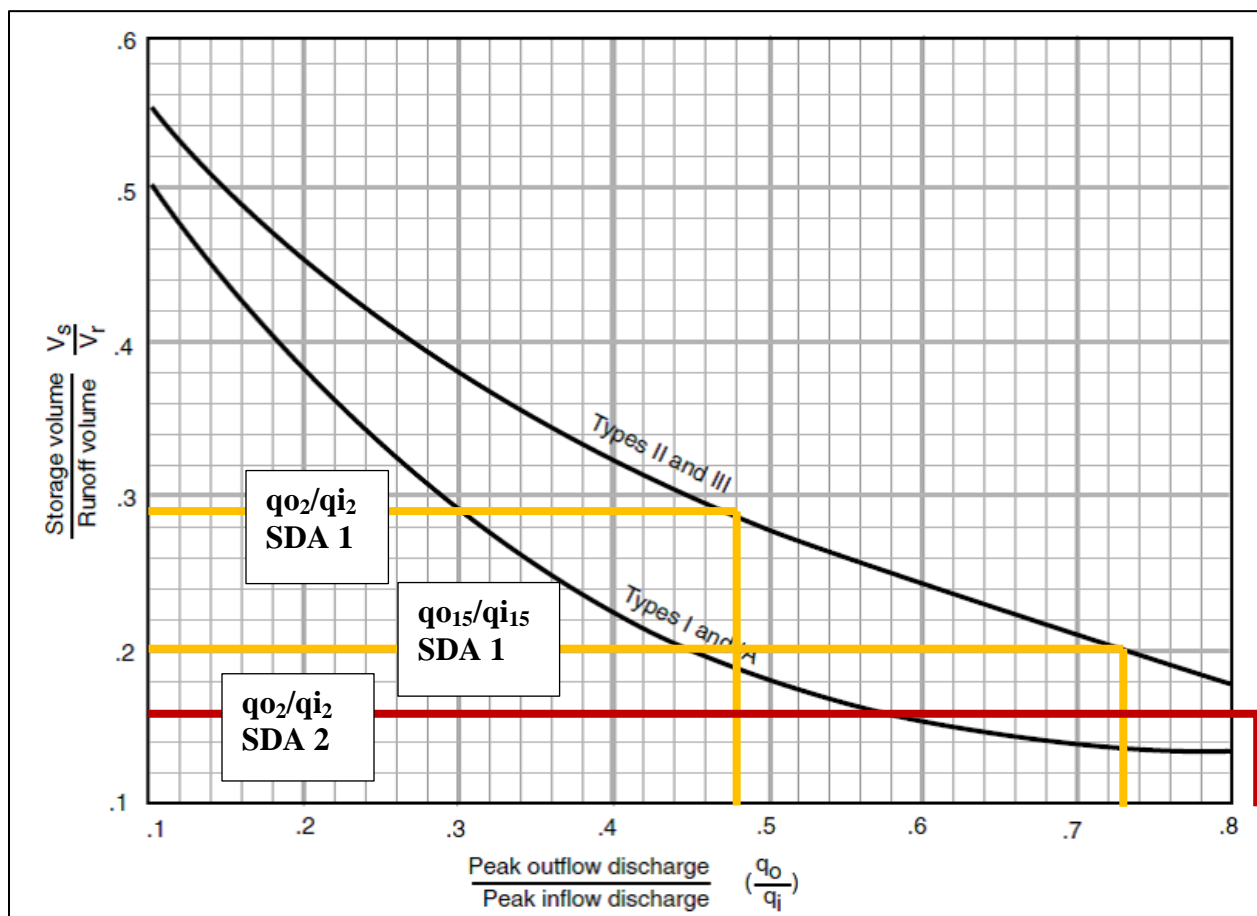


Figure I.4 Approximate detention basin routing for Example 1a.

For SDA 1:

$$V_{S_2}/V_{r_2} = 0.29$$

$$V_{S_{15}}/V_{r_{15}} = 0.20$$

For SDA 2:

$$V_{S_2}/V_{r_2} = 0.16$$

**Step 4: Determine the runoff volumes  $V_{r_2}$  and  $V_{r_{15}}$ .**

SDA 1:

$$V_{r_2} = \frac{Q_2}{12} \times SDA$$

$$V_{r_2} = \frac{0.98 \text{ in.}}{12} \times 0.53 \text{ acre} \times 43,560 = 1,885 \text{ cubic feet}$$

$$V_{r_{15}} = \frac{Q_{15}}{12} \times SDA$$

$$V_{r_{15}} = \frac{3.00 \text{ in.}}{12} \times 0.53 \text{ acre} \times 43,560 = 5,772 \text{ cubic feet}$$

SDA 2:

$$V_{r_2} = \frac{Q_2}{12} \times SDA$$

$$V_{r_2} = \frac{0.46 \text{ in.}}{12} \times 0.57 \times 43,560 = 952 \text{ cubic feet}$$

**Step 5: Multiply the  $V_s/V_r$  ratios from Step 1 by the runoff volumes  $V_{r_2}$  and  $V_{r_{15}}$  from Step 2 to determine the required storage volumes,  $V_{S_2}$  and  $V_{S_{15}}$ , in acre-feet.**

SDA 1:

$$\left(\frac{V_{S_2}}{V_{r_2}}\right) V_{r_2} = V_{S_2}$$

$$(0.29) \times 1,885 \text{ cubic feet} = 547 \text{ cubic feet}$$

$$\left(\frac{V_{S_{15}}}{V_{r_{15}}}\right) V_{r_{15}} = V_{S_{15}}$$

$$(0.20) \times 5,772 \text{ cubic feet} = 1,154 \text{ cubic feet}$$

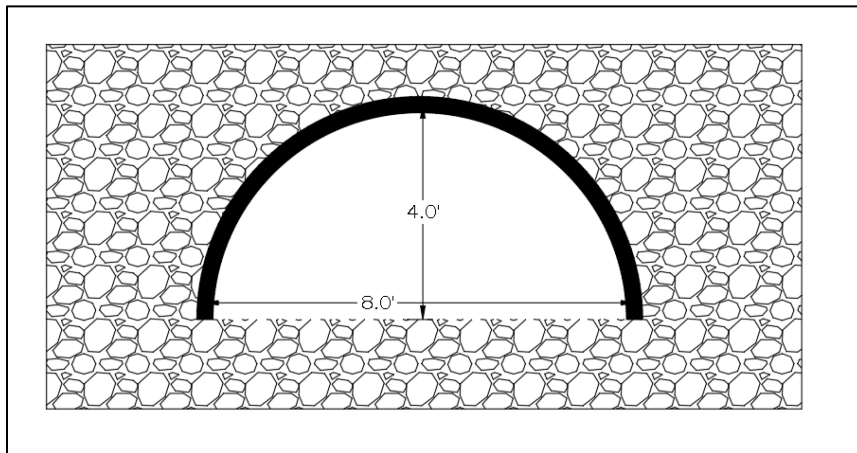
SDA 2:

$$\left(\frac{V_{S_2}}{V_{r_2}}\right) V_{r_2} = V_{S_2}$$

$$(0.16) \times 952 \text{ cubic feet} = 152 \text{ cubic feet}$$

**Step 6:** Design a storage practice that holds the required volume with one or more orifices or other outlet devices that limit the outflow to the allowable discharge rates for the 2-year and 15-year storms.

In this example, a 4-foot high, 8-foot wide arch pipe-type tank will be used for both SDAs. The tank has a cross sectional area of 25.12 cubic feet (Figure I.5).



**Figure I.5** Cross sectional view of arch pipe tank.

For SDA 1, to meet the 15-year storage volume requirement of 1,154 cubic feet, the tank length will need to be at least 46 feet long. Analysis of the cross-section indicates that the 2-year storm storage volume of 547 cubic feet will rise to an elevation of 1.51 feet in this tank.

Next, the orifices must be designed. With a known depth in the tank, the outflow from the orifice is calculated based on this equation from Appendix H.1 - Circular Orifices.

$$Q = CA(2gh)^{0.5}$$

where:

- $Q$  = orifice discharge (cfs)
- $C$  = discharge coefficient = 0.6
- $A$  = orifice cross-sectional area (ft<sup>2</sup>) =  $3.1416 \times \frac{D^2}{4}$
- $D$  = diameter of orifice (ft)
- $g$  = gravitational acceleration (32.2 ft/s<sup>2</sup>)
- $h$  = hydraulic head above the center of the orifice (ft)

For the two-year storm, the hydraulic head will be 1.51 feet and the target discharge will be 0.59 cfs:

$$0.59 \text{ cfs} = 0.6 \times 3.1416 \times \frac{D^2}{4} \left( 2 \times 32.2 \frac{\text{ft}}{\text{s}^2} \times 1.51 \text{ ft} \right)^{0.5}$$

Solving for D, the maximum orifice size is 0.36 feet; a 4-inch orifice (0.33 feet) will be used.

For the 15-year storm, the peak flow out the lowest orifice needs to be calculated first, with a hydraulic head of 4 feet.

$$Q = 0.6 \times 3.1416 \times \frac{(0.33 \text{ ft})^2}{4} \left( 2 \times 32.2 \frac{\text{ft}}{\text{s}^2} \times 4 \text{ ft} \right)^{0.5} = 0.82 \text{ cfs}$$

The second orifice will be located at elevation 1.51 feet, the peak elevation of the 2-year storm, so it does not impact the 2-year detention. The head on the second orifice will then be 4 feet – 1.51 feet = 2.49 feet. The target discharge that will flow through the second orifice will be 2.09 cfs – 0.82 cfs = 1.27 cfs.

$$1.27 \text{ cfs} = 0.6 \times 3.1416 \times \frac{D^2}{4} \left( 2 \times 32.2 \frac{\text{ft}}{\text{s}^2} \times 2.49 \text{ ft} \right)^{0.5}$$

Solving for D, the maximum orifice size is 0.46 feet, or 5.5 inches.

For SDA 1, the final detention tank design will be a 46-foot long, 4-foot by 8-foot arch culvert with a 4-inch orifice at the bottom and a 5.5-inch orifice at elevation 1.51 feet. The 2-year peak flow will be reduced to 0.59 cfs, and the 15-year peak flow will be reduced to 2.09 cfs.

For SDA 2, detention will only be needed for the 2-year storm. To meet the 15-year storage volume requirement of 152 cubic feet, the 25.12 square-foot tank will only need to be 6.1 feet long.

With a known depth in the tank, the outflow from the orifice is calculated based on this equation from Appendix H.1 - Circular Orifices.

$$Q = CA(2gh)^{0.5}$$

where:

- $Q$  = orifice discharge (cfs)
- $C$  = discharge coefficient = 0.6
- $A$  = orifice cross-sectional area (ft<sup>2</sup>) =  $3.1416 \times \frac{D^2}{4}$
- $D$  = diameter of orifice (ft)
- $g$  = gravitational acceleration (32.2 ft/s<sup>2</sup>)
- $h$  = hydraulic head above the center of the orifice (ft)

Since this tank will have only one orifice, hydraulic head will be 4 feet, and the target discharge will be 0.64 cfs:

$$0.64 \text{ cfs} = 0.6 \times 3.1416 \times \frac{D^2}{4} (2 \times 32.2 \frac{\text{ft}}{\text{s}^2} \times 4 \text{ ft})^{0.5}$$

Solving for D, the maximum orifice size is 0.29 feet, or 3.5 inches.

For SDA 2, the final detention tank design will be a 6.1-foot long, 4-foot by 8-foot arch culvert with a 3.5-inch orifice at the bottom. The 2-year peak flow will be reduced to 0.64 cfs.

### I.3 Storage-Indication Routing

Storage-Indication Routing may be used to analyze storage detention practices. This approach requires that the inflow hydrograph be developed through one of the methods listed in this appendix (TR-55, WinTR-55, SWMM, etc.), as well as the required maximum outflows,  $q_{o2}$  and  $q_{o15}$ . Using the stage-discharge relationship for a given combination outlet devices, the detention volume necessary to achieve the maximum outflows can be determined.

Storage-Indication Routing provides a more accurate analysis of detention volume requirements than the TR-55 shortcut procedure described in Section I.1.

#### Example 1b

Example 1b below uses the same site design as Example 1a in Section I.1 above. While the total tank size is very similar in both analyses, Example 1b locates detention only in one site drainage area (SDA 1), while accounting for the undetained flows in SDA 2.

A 48,000 square foot development is proposed on Type C soils. SDA 1 will include a parking lot and a bioretention area (Figure I.6). SDA 2 will include a building and a green roof (Figure I.7).



Predevelopment conditions on both SDAs yield a curve number of 70. In SDA 1, preproject conditions include only turf cover, yielding a curve number of 74. Pre-project conditions in SDA 2 include both impervious and turf areas, yielding a curve number of 86. These values are indicated in Table I.6. Based on the proposed land covers and the implementation of the bioretention and green roof (which serve to reduce curve numbers), the post-development curve numbers are also indicated in Table I.6.



SDA 1 = 23,000 ft<sup>2</sup>  
 Post-Development CN (2-year/15-year) = 82/85

Figure I.6 SDA 1 for Example 1b.



SDA 2 = 25,000 ft<sup>2</sup>  
 Post-Development CN (2-year/15-year) = 71/78

Figure I.7 SDA 2 for Example 1b.

Table I.6 Curve Numbers for Example 1b.

	Area	Predevelopment Curve Number	2-Year Post-Development Curve Number <sup>1</sup>	Pre-Project Curve Number	15-Year Post-Development Curve Number <sup>1</sup>
SDA 1	23,000 ft <sup>2</sup>	70	82	74	85
SDA 2	25,000 ft <sup>2</sup>	70	71	86	78
<b>Total Site</b>	<b>48,000 ft<sup>2</sup></b>	<b>70</b>	<b>76</b>	<b>80</b>	<b>81</b>

1. These values incorporate the reductions achieved due to the implementation of the bioretention area and the green roof.

**Step 1: Determine if detention is required.**

For the total site, the 2-year post-development curve number of 76 is greater than the predevelopment curve number of 70, and the 15-year post-development curve number of 81 is greater than the pre-project curve number of 80. Therefore, detention will be needed for both the 2-year and 15-year storm.

**Step 2: Calculate the predevelopment, pre-project, and post-development peak flows.**

There are several programs available for developing runoff hydrographs. WinTR-55 will be used in this example. The WinTR-55 program and support materials, including the User Guide can be found here:

<https://www.nrcs.usda.gov/wps/portal/nrcs/detailfull/national/water/?cid=stelprdb1042901>

Eight different model scenarios will be needed with the following inputs/characteristics (Tables I.7 and I.8).

**Table I.7 SDA 1 TR-55 Model Scenarios for Example 1b.**

<b>Input</b>	<b>2- Year Predevelopment</b>	<b>2-Year Post-Development</b>	<b>15-Year Pre-Project</b>	<b>15-Year Post-Development</b>
Area	0.53 acre			
Curve Number	70	82	74	85
Time of Concentration <sup>1</sup>	0.1 hour			
Rainfall Depth <sup>2</sup>	3.14 inches	3.14 inches	5.23 inches	5.23 inches

**Table I.8 SDA 2 TR-55 Model Scenarios for Example 1b.**

<b>Input</b>	<b>2- Year Predevelopment</b>	<b>2-Year Post-Development</b>	<b>15-Year Pre-Project</b>	<b>15-Year Post-Development</b>
Area	0.57 acre			
Curve Number	70	71	86	78
Time of Concentration <sup>1</sup>	0.1 hour			
Rainfall Depth <sup>2</sup>	3.14 inches	3.14 inches	5.23 inches	5.23 inches

1. Actual drainage characteristics (flow lengths, slopes, etc.) shall be used, but the minimum Tc must be 6 minutes (0.1 hours).

2. The NRCS Type II Storm Event shall be used.

Using these inputs, WinTR-55 can produce peak flow rates for the various scenarios (Table I.9).

**Table I.9 Example 1b Peak Flow Rates for SDA 1 and SDA 2.**

<b>SDA</b>	<b>2- Year Predevelopment Peak Flow</b>	<b>2-Year Post-Development Peak Flow</b>	<b>15-Year Pre-Project Peak Flow</b>	<b>15-Year Post-Development Peak Flow</b>
SDA 1	0.59 cfs	1.22 cfs	2.09 cfs	2.88 cfs
SDA 2	0.64 cfs	0.69 cfs	3.17 cfs	2.55 cfs
<b>Total<sup>1</sup></b>	<b>1.23 cfs</b>	<b>1.91 cfs</b>	<b>5.26 cfs</b>	<b>5.43 cfs</b>

1. In this example, the timing of peak flows was very similar for each SDA, so the peak flows could simply be added to determine the total site peak flows. If the peak times between different SDAs are different, then the total site peak flows will be less than the sum of the peak flows from each SDA.

**Step 3: Determine the peak flow reduction targets.**

From Table I.9 it is clear that the majority of the detention needs are in SDA 1. For SDA 2, the 2-year post-development peak flow is only slightly higher than the predevelopment peak flow, and the 15-year post-development peak flow is lower than the post-development peak flow. So,

underground detention is proposed only in SDA 1. In order to reduce the total site 2-year post-development peak flow to the pre-development rate of 1.23 cfs, the 2-year post-development peak flow in SDA 1 will need to be reduced from 1.22 cfs to 0.54 cfs.

$$1.91 \text{ cfs} - 1.23 \text{ cfs} = 0.68 \text{ cfs}$$

$$1.22 \text{ cfs} - 0.68 \text{ cfs} = 0.54 \text{ cfs}$$

To reduce the total site 15-year post-development peak flow to 5.26 cfs, the 15-year post-development peak flow in SDA 1 will need to be reduced from 2.88 cfs to 2.71 cfs.

$$5.43 \text{ cfs} - 5.26 \text{ cfs} = 0.17 \text{ cfs}$$

$$2.88 \text{ cfs} - 0.17 \text{ cfs} = 2.71 \text{ cfs}$$

**Step 4: Set up the stage-storage tables with the post-development hydrographs for the 2-year storm.**

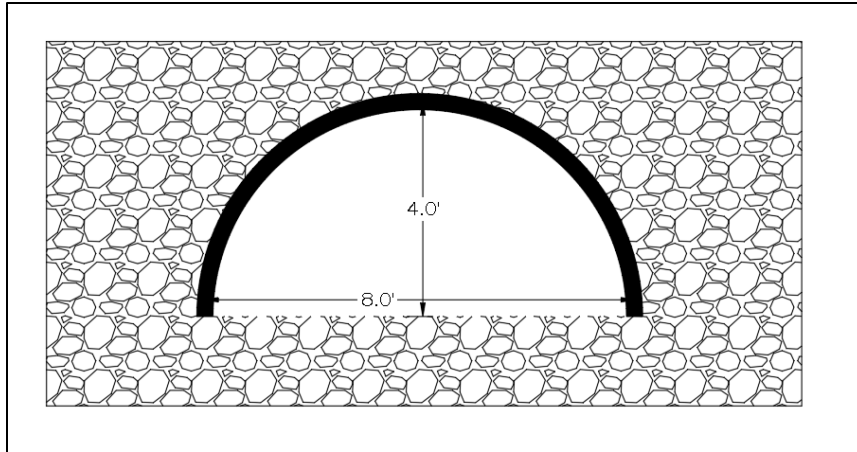
The hydrograph tables produced by WinTR-55 (Select WinTR-20 Reports → Printed Page File) can be pasted into a spreadsheet. Starting with the time increments and the flow rates from the hydrograph, a simple conversion will yield the volume of water that enters the storage tank during each time interval (Figure I.8).

$$\text{Volume of water} = (\text{Time B (hrs)} - \text{Time A (hrs)}) \times \text{Flow A (cfs)} \times 3,600 \text{ sec/hr}$$

Time (hrs)	Flow (cfs)	Volume Inflow (cf)
11.432	0.05	7.92
11.476	0.06	9.50
11.52	0.07	11.09
11.565	0.1	16.20
11.609	0.13	20.59
11.653	0.21	33.26

**Figure I.8 Spreadsheet excerpt for Example 1b.**

Once the volume of water entering the storage tank per time increment is determined, a tank size and an orifice size must be assumed. This will be an iterative process to determine the smallest tank size that is sufficient to meet the detention requirements for both the 2-year and 15-year storm event. In this case, a 4-foot high, 8-foot wide arch pipe-type tank will be used, and the length will be modified as needed to meet the detention requirements (Figure I.9).



**Figure I.9. Cross sectional view of arch pipe tank.**

It is essential to know the cross-sectional area in the tank per unit of depth in the tank. For this example, the cross-sectional area varies with water depth according to Table I.10.

**Table I.10 Depth Versus Area for Example Arch Pipe Tank**

Depth (ft)	Cross-Sectional Area of Tank (ft <sup>2</sup> )
0.0	0.00
0.5	4.02
1.0	7.95
1.5	11.74
2.0	15.34
2.5	18.64
3.0	21.53
3.5	23.85
4.0	25.12

From the data in Table I.10, the relationship between area and depth for this specific design can be expressed as follows:

$$D = 2.192 \times 10^{-7}(A^6) - 1.529 \times 10^{-5}(A^5) + 4.043 \times 10^{-4}(A^4) - 4.951 \times 10^{-3}(A^3) + 2.789 \times 10^{-2}(A^2) + 6.906 \times 10^{-2}(A)$$

where:

- $D$  = Depth of water in the arch pipe (ft)
- $A$  = Cross-sectional area of water in the arch pipe (ft<sup>2</sup>)

With an assumed length of 40 feet of tank, and the cross section equation above, the 7.92 cubic feet of water in the tank in the first time interval produces a depth of water of 0.015 feet (Figure I.10).

$$Area = \frac{Volume\ of\ Water\ in\ Tank}{Length\ of\ Tank} = \frac{7.92\ cf}{40\ cf} = 0.20\ ft^2$$

$$D = 2.192 \times 10^{-7}(0.20^6) - 1.529 \times 10^{-5}(0.20^5) + 4.043 \times 10^{-4}(0.20^4) - 4.951 \times 10^{-3}(0.20^3) + 2.789 \times 10^{-2}(0.20^2) + 6.906 \times 10^{-2}(0.20) = 0.015\ ft$$

Time (hrs)	Flow (cfs)	Volume Inflow (cf)	Volume in Tank (cf)	Area in Tank (sf)	Depth in Tank (ft)
11.432	0.05	7.92	7.92	0.20	0.015

**Figure I.10 Spreadsheet excerpt for Example 1b.**

Next, assume an orifice size. With a known depth in the tank, the outflow from the orifice is calculated based on these two equations from Appendix H.1 - Circular Orifices.

$$Q = CA(2gh)^{0.5}$$

where:

- $Q$  = orifice discharge (cfs)
- $C$  = discharge coefficient = 0.6
- $A$  = orifice cross-sectional area (ft<sup>2</sup>) =  $3.1416 \times \frac{D^2}{4}$
- $D$  = diameter of orifice (ft)
- $g$  = gravitational acceleration (32.2 ft/s<sup>2</sup>)
- $h$  = hydraulic head above the center of the orifice (ft)

When  $h < D$ , the orifice shall be treated as a weir:

$$Q = CLH^{3/2}$$

where:

- $Q$  = flow through the weir (cfs)
- $C$  = discharge coefficient = 3
- $L$  = diameter of orifice (ft)
- $H$  = hydraulic head above bottom of weir opening (ft)

Assuming a 6-inch orifice (0.5 feet), the 0.015-foot depth in the tank yields:

$$Q = CLH^{3/2} = 3 \times 0.5 \text{ ft} \times (0.015 \text{ ft})^{3/2} = 0.003 \text{ cfs}$$

The outflow in the first time interval is then used to determine the volume and depth of water in the tank in the second time interval (Figure I.11).

$$\begin{aligned} \text{Volume in Tank} &= \text{Volume from previous time interval} \\ &\quad - \text{Outflow in previous time interval} \\ &\quad + \text{Inflow in the current time interval} \end{aligned}$$

$$\text{Volume in Tank} = 7.92 \text{ cf} - 0.003 \text{ cfs} \times 0.044 \text{ hr} \times 3600 \frac{\text{sec}}{\text{hr}} + 9.5 \text{ cf} = 17.00 \text{ cf}$$

Time (hrs)	Flow (cfs)	Volume Inflow (cf)	Volume in Tank (cf)	Area in Tank (sf)	Depth in Tank (ft)	Outflow (cfs)
11.432	0.05	7.92	7.92	0.20	0.015	0.003
11.476	0.06	9.50	17.00	0.42	0.034	0.009

**Figure I.11 Spreadsheet excerpt for Example 1b.**

At this point, the cycle repeats. The volume in the tank yields a depth calculation, which yields an orifice outflow calculation, which combines with the next inflow volume to yield a new volume in the tank. This calculation process is repeated for every time interval in the spreadsheet (Figure I.12).

Time (hrs)	Flow (cfs)	Volume Inflow (cf)	Volume in Tank (cf)	Area in Tank (sf)	Depth in Tank (ft)	Outflow (cfs)
11.432	0.05	7.92	7.92	0.20	0.015	0.003
11.476	0.06	9.50	17.00	0.42	0.034	0.009
11.52	0.07	11.09	26.60	0.66	0.057	0.020
11.565	0.1	16.20	39.50	0.99	0.091	0.041
11.609	0.13	20.59	53.57	1.34	0.132	0.072
11.653	0.21	33.26	75.46	1.89	0.201	0.135
11.697	0.28	44.35	98.39	2.46	0.278	0.220
11.741	0.4	63.36	126.85	3.17	0.378	0.348
11.786	0.53	85.86	156.28	3.91	0.481	0.501
11.83	0.73	115.63	192.57	4.81	0.607	0.734
11.874	1.07	169.49	245.77	6.14	0.783	0.834
11.918	1.22	193.25	306.84	7.67	0.975	0.931
11.962	1.12	177.41	336.71	8.42	1.066	0.974
12.007	1.03	166.86	345.71	8.64	1.094	0.987
12.051	0.65	102.96	292.33	7.31	0.930	0.910
12.095	0.36	57.02	205.26	5.13	0.650	0.760
12.139	0.25	39.60	124.51	3.11	0.370	0.337
12.184	0.21	34.02	103.94	2.60	0.298	0.244
12.228	0.19	30.10	95.46	2.39	0.268	0.209
12.272	0.18	28.51	90.95	2.27	0.253	0.191
12.316	0.17	26.93	87.65	2.19	0.242	0.178
12.36	0.15	23.76	83.17	2.08	0.227	0.162
12.405	0.15	24.30	81.25	2.03	0.220	0.155
12.449	0.13	20.59	77.29	1.93	0.207	0.141
12.493	0.12	19.01	73.91	1.85	0.196	0.130
12.537	0.11	17.42	70.72	1.77	0.186	0.120

**Figure I.12 Spreadsheet excerpt for Example 1b.**

When this is complete, the designer can determine if the storage tank is big enough so that it does not overflow (but not too big) and if the peak outflow rate is below the required target. The length of the tank and the orifice can be adjusted to compensate as needed. In this case, it appears that the orifice is too big to keep the outflow rate below the 0.54 cfs target. The depth of water in the tank rises to just over 1 foot, while the peak outflow is 0.987 cfs. Reducing the orifice to 3 inches yields a new peak outflow of 0.407 cfs (Figure I.13).

Time (hrs)	Flow (cfs)	Volume Inflow (cf)	Volume in Tank (cf)	Area in Tank (sf)	Depth in Tank (ft)	Outflow (cfs)
11.432	0.05	7.92	7.92	0.20	0.015	0.001
11.476	0.06	9.50	17.21	0.43	0.034	0.005
11.52	0.07	11.09	27.54	0.69	0.059	0.011
11.565	0.1	16.20	41.99	1.05	0.098	0.023
11.609	0.13	20.59	58.94	1.47	0.148	0.043
11.653	0.21	33.26	85.42	2.14	0.234	0.085
11.697	0.28	44.35	116.31	2.91	0.341	0.138
11.741	0.4	63.36	157.87	3.95	0.487	0.165
11.786	0.53	85.86	217.07	5.43	0.689	0.196
11.83	0.73	115.63	301.67	7.54	0.959	0.231
11.874	1.07	169.49	434.53	10.86	1.372	0.277
11.918	1.22	193.25	583.96	14.60	1.895	0.325
11.962	1.12	177.41	709.86	17.75	2.372	0.364
12.007	1.03	166.86	817.76	20.44	2.789	0.395
12.051	0.65	102.96	858.22	21.46	2.961	0.407
12.095	0.36	57.02	850.84	21.27	2.928	0.404
12.139	0.25	39.60	826.40	20.66	2.824	0.397
12.184	0.21	34.02	796.10	19.90	2.703	0.388
12.228	0.19	30.10	764.67	19.12	2.581	0.380
12.272	0.18	28.51	733.05	18.33	2.461	0.371
12.316	0.17	26.93	701.28	17.53	2.340	0.361
12.36	0.15	23.76	667.79	16.69	2.212	0.351
12.405	0.15	24.30	635.17	15.88	2.088	0.341
12.449	0.13	20.59	601.68	15.04	1.962	0.331
12.493	0.12	19.01	568.28	14.21	1.837	0.320
12.537	0.11	17.42	534.99	13.37	1.716	0.309

**Figure I.13 Spreadsheet excerpt for Example 1b.**

The maximum depth in the tank is 2.96 feet, well below the 4.0-foot tank height. Reducing the length of the tank would increase the depth of water to better utilize the tank volume, but it will also increase the flow rate out of the orifice. It is important to find the right balance between tank size and orifice size. Before effort is taken to optimize the tank size for the 2-year storm, the next step is to analyze the tank’s response to the 15-year storm.

**Step 5: Set up the stage-storage tables with the post-development hydrographs for the 15-year storm.**

As stated above, the 15-year post-development peak flow must be reduced from 2.88 cfs to 2.71 cfs. The stage-storage table for the 15-year storm is set up in the same manner as the table for the



2-year storm; the only difference will be the time and flow inputs from the hydrograph. The TR-55 inputs for the 15-year storm yield the following stage-storage table (Figure I.14).

Time (hrs)	Flow (cfs)	Volume Inflow (cf)	Volume in Tank (cf)	Area in Tank (sf)	Depth in Tank (ft)	Outflow (cfs)
11.016	0.11	17.42	90.41	2.26	0.251	0.118
11.061	0.12	19.44	90.74	2.27	0.252	0.118
11.105	0.12	19.01	91.02	2.28	0.253	0.118
11.149	0.13	20.59	92.85	2.32	0.259	0.120
11.193	0.14	22.18	96.03	2.40	0.270	0.122
11.237	0.15	23.76	100.39	2.51	0.285	0.126
11.282	0.16	25.92	105.93	2.65	0.305	0.130
11.326	0.16	25.34	110.68	2.77	0.321	0.134
11.37	0.17	26.93	116.46	2.91	0.341	0.138
11.414	0.18	28.51	123.16	3.08	0.365	0.142
11.459	0.19	30.78	130.88	3.27	0.392	0.148
11.503	0.22	34.85	142.34	3.56	0.432	0.155
11.547	0.33	52.27	170.05	4.25	0.529	0.172
11.591	0.42	66.53	209.39	5.23	0.664	0.192
11.635	0.63	99.79	278.73	6.97	0.887	0.222
11.68	0.83	134.46	377.16	9.43	1.191	0.258
11.724	1.09	172.66	509.00	12.72	1.623	0.301
11.768	1.41	223.34	684.67	17.12	2.277	0.356
11.812	1.81	286.70	914.91	22.87	3.250	0.426
11.856	2.57	407.09	1254.52	31.36	12.679	0.842
11.901	2.88	466.56	1584.75	39.62	89.949	2.242
11.945	2.6	411.84	1641.52	41.04	121.684	2.607
11.989	2.33	369.07	1597.61	39.94	96.429	2.321
12.033	1.54	243.94	1473.91	36.85	48.071	1.639
12.077	0.81	128.30	1342.64	33.57	21.737	1.102
12.122	0.56	90.72	1254.86	31.37	12.705	0.842

**Figure I.14 Spreadsheet excerpt for Example 1b. (Note: the first few rows were removed to fit the table on the page).**

With our 40-foot tank and 3-inch orifice, the peak 15-year outflow will be 2.607 cfs, which meets our target. However, the depth of water in the tank is 121 feet – much higher than the actual 4-foot tank height. More storage will be required, as well as a second orifice to increase the outflow allowed during the 15-year flow without affecting the 2-year results. This is done by setting the second orifice invert at the highest tank depth for the 2-year storm and revising the orifice equations accordingly. The 2-year flow topped out at 2.96 feet, so a second orifice will be set there. The outflow equations used are the same, with adjustments made for the elevation of the orifice (no water will flow out of the orifice until the water depth exceeds 2.96 feet). Assuming a 6-inch orifice, the spreadsheet is updated as shown in Figure I.15.

Time (hrs)	Flow (cfs)	Volume Inflow (cf)	Volume in Tank (cf)	Area in Tank (sf)	Depth in Tank (ft)	Outflow 1 (cfs)	Outflow 2 (cfs)	Total Outflow
11.016	0.11	17.42	90.41	2.26	0.251	0.118	0.000	0.118
11.061	0.12	19.44	90.74	2.27	0.252	0.118	0.000	0.118
11.105	0.12	19.01	91.02	2.28	0.253	0.118	0.000	0.118
11.149	0.13	20.59	92.85	2.32	0.259	0.120	0.000	0.120
11.193	0.14	22.18	96.03	2.40	0.270	0.122	0.000	0.122
11.237	0.15	23.76	100.39	2.51	0.285	0.126	0.000	0.126
11.282	0.16	25.92	105.93	2.65	0.305	0.130	0.000	0.130
11.326	0.16	25.34	110.68	2.77	0.321	0.134	0.000	0.134
11.37	0.17	26.93	116.46	2.91	0.341	0.138	0.000	0.138
11.414	0.18	28.51	123.16	3.08	0.365	0.142	0.000	0.142
11.459	0.19	30.78	130.88	3.27	0.392	0.148	0.000	0.148
11.503	0.22	34.85	142.34	3.56	0.432	0.155	0.000	0.155
11.547	0.33	52.27	170.05	4.25	0.529	0.172	0.000	0.172
11.591	0.42	66.53	209.39	5.23	0.664	0.192	0.000	0.192
11.635	0.63	99.79	278.73	6.97	0.887	0.222	0.000	0.222
11.68	0.83	134.46	377.16	9.43	1.191	0.258	0.000	0.258
11.724	1.09	172.66	509.00	12.72	1.623	0.301	0.000	0.301
11.768	1.41	223.34	684.67	17.12	2.277	0.356	0.000	0.356
11.812	1.81	286.70	914.91	22.87	3.250	0.426	0.506	0.932
11.856	2.57	407.09	1174.35	29.36	8.016	0.669	2.125	2.794
11.901	2.88	466.56	1188.27	29.71	8.645	0.695	2.254	2.948
11.945	2.6	411.84	1133.08	28.33	6.494	0.602	1.776	2.379
11.989	2.33	369.07	1125.39	28.13	6.260	0.591	1.716	2.308
12.033	1.54	243.94	1003.78	25.09	3.969	0.471	0.948	1.418
12.077	0.81	128.30	907.42	22.69	3.207	0.423	0.467	0.890
12.122	0.56	90.72	854.01	21.35	2.942	0.405	0.000	0.405
12.166	0.46	72.86	862.68	21.57	2.981	0.408	0.125	0.533
12.21	0.41	64.94	843.24	21.08	2.895	0.402	0.000	0.402

**Figure I.15 Spreadsheet excerpt for Example 1b. (Note: the first few rows were removed to fit the table on the page).**

The total outflow in the above example is 2.948 cfs with an 8.65-foot depth in the tank; both values are still too high. Trial and error is needed to determine the right combination of tank size and orifice sizes to meet the 15-year peak flow requirement. Testing several combinations in this example led to an ideal tank length of 54 feet, with a 3-inch lower orifice and an 8-inch orifice set at the 2-year depth of 2.24 feet (Figure I.16).

Time (hrs)	Flow (cfs)	Volume Inflow (cf)	Volume in Tank (cf)	Area in Tank (sf)	Depth in Tank (ft)	Outflow 1 (cfs)	Outflow 2 (cfs)	Total Outflow
11.016	0.11	17.42	122.17	2.26	0.251	0.118	0.000	0.118
11.061	0.12	19.44	122.49	2.27	0.252	0.118	0.000	0.118
11.105	0.12	19.01	122.77	2.27	0.253	0.118	0.000	0.118
11.149	0.13	20.59	124.60	2.31	0.258	0.119	0.000	0.119
11.193	0.14	22.18	127.85	2.37	0.266	0.121	0.000	0.121
11.237	0.15	23.76	132.38	2.45	0.277	0.124	0.000	0.124
11.282	0.16	25.92	138.21	2.56	0.292	0.127	0.000	0.127
11.326	0.16	25.34	143.39	2.66	0.305	0.130	0.000	0.130
11.37	0.17	26.93	149.69	2.77	0.322	0.134	0.000	0.134
11.414	0.18	28.51	157.03	2.91	0.341	0.138	0.000	0.138
11.459	0.19	30.78	165.52	3.07	0.363	0.142	0.000	0.142
11.503	0.22	34.85	177.87	3.29	0.395	0.148	0.000	0.148
11.547	0.33	52.27	206.67	3.83	0.470	0.162	0.000	0.162
11.591	0.42	66.53	247.58	4.58	0.575	0.179	0.000	0.179
11.635	0.63	99.79	319.02	5.91	0.752	0.205	0.000	0.205
11.68	0.83	134.46	420.31	7.78	0.988	0.235	0.000	0.235
11.724	1.09	172.66	555.78	10.29	1.299	0.269	0.000	0.269
11.768	1.41	223.34	736.49	13.64	1.754	0.313	0.000	0.313
11.812	1.81	286.70	973.65	18.03	2.416	0.367	0.701	1.068
11.856	2.57	407.09	1211.56	22.44	3.153	0.420	1.617	2.037
11.901	2.88	466.56	1348.17	24.97	3.913	0.467	2.192	2.660
11.945	2.6	411.84	1338.73	24.79	3.840	0.463	2.144	2.607
11.989	2.33	369.07	1294.82	23.98	3.551	0.445	1.940	2.385
12.033	1.54	243.94	1160.97	21.50	2.969	0.407	1.444	1.851
12.077	0.81	128.30	996.02	18.44	2.479	0.372	0.820	1.192
12.122	0.56	90.72	893.62	16.55	2.190	0.350	0.000	0.350

**Figure I.16 Spreadsheet excerpt for Example 1b. (Note: the first few rows were removed to fit the table on the page).**

This final arrangement of tank length and orifices yields a 15-year peak outflow of 2.66 cfs and a maximum depth of 3.91 feet, so the 2.71 cfs target is met. Checking this arrangement against the 2-year flows yields a 2-year peak outflow of 0.35 cfs and a maximum depth of 2.24 feet, so the 0.54 cfs target is met (Figures I.17 and I.18). Therefore, detention requirements for the site are met.

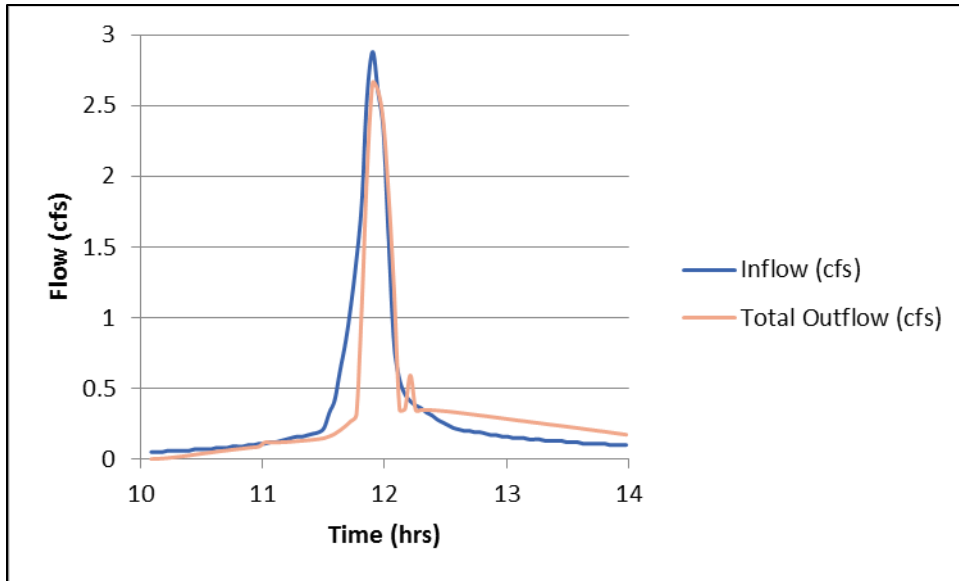


Figure I.17 Inflow vs. detained outflow for Example 1b 15-year storm.

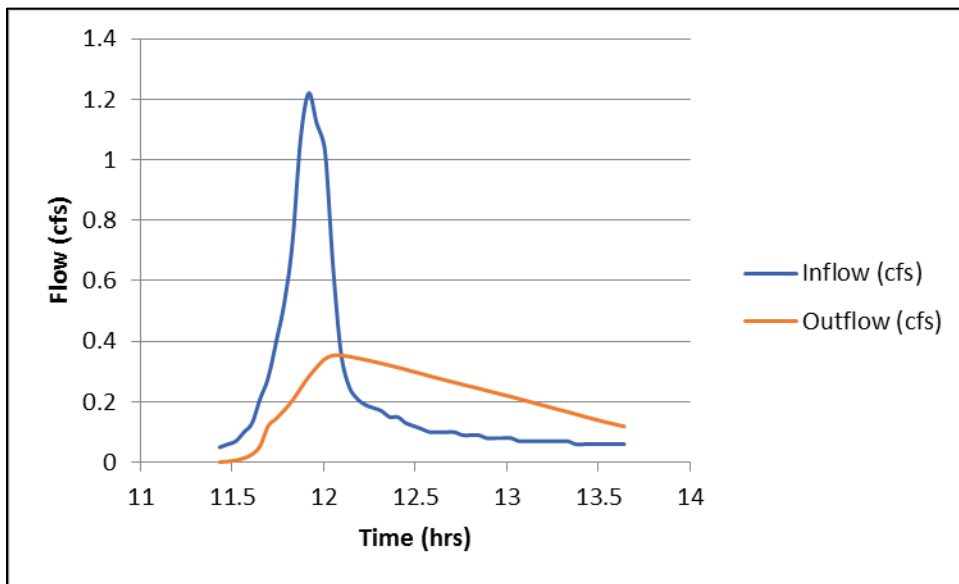


Figure I.18 Inflow vs. detained outflow for Example 1b 2-year storm.

### Example 2

Example 2 describes a unique detention situation in which the development includes both major substantial improvement and major land disturbing activities.

A 36,000 square foot development is proposed on Type B soils. The development has one SDA and includes a 15,000 square foot building that will be renovated, qualifying it as a major substantial improvement (MSI) project. A green roof will be added to the building to meet the SWRV requirements. The remaining 21,000 square feet will be a major land disturbing project

(MLD), a mix of impervious cover and turf cover, with bioretention areas used to meet the SWRv requirements (Figure I.19).

For the MLD area, detention must be provided to meet the predevelopment peak flow for the 2-year storm and the pre-project peak flow for the 15-year storm. Peak flows may be analyzed for the whole site, so the predevelopment peak discharge for the MSI area can be included in the analysis. In other words, the allowable discharge from the site for the 2-year storm is equal to the predevelopment peak flow from the MLD area plus the pre-project peak flow from the MSI area. The allowable discharge from the site for the 15-year storm is equal to the pre-project peak flow from the MLD area plus the pre-project peak flow from the MSI area.

Predevelopment conditions on Type B soils equate to a curve number of 58. In the MSI, pre-project conditions are entirely impervious cover for a curve number of 98. Pre-project conditions in the MLD include both impervious and turf areas yielding a curve number of 79. These values are indicated in Table I.11. Based on the proposed land covers and the implementation of the green roof and bioretention areas (which serve to reduce curve numbers), the post-development curve numbers are also indicated in Table I.11.



**Figure I.19 Site diagram for Example 2.**

**Table I.11 Example 2 Curve Numbers.**

	Area	Predevelopment Curve Number	2-Year Post-Development Curve Number <sup>1</sup>	Pre-Project Curve Number	15-Year Post-Development Curve Number <sup>1</sup>
MSI Area	15,000 ft <sup>2</sup>	N/A	86	98	88
MLD Area	21,000 ft <sup>2</sup>	58	76	79	80
<b>Total Site</b>	<b>36,000 ft<sup>2</sup></b>	<b>75<sup>2</sup></b>	<b>80</b>	<b>87</b>	<b>83</b>

1. These values incorporate the reductions achieved due to the implementation of the bioretention area and the green roof.
2. As described above, the pre-project curve number of 98 for the MSI area is used to calculate the total site predevelopment curve number since detention is not required for the MSI area.

**Step 1: Determine if detention is required.**

Detention rules apply to the site as a whole rather than the individual SDAs, so to determine if detention is required, compare the curve numbers for the total site. For the total site, the 2-year post development curve number of 80 is greater than the predevelopment curve number of 75, so detention is required for the 2-year storm. The 15-year post-development curve number of 83 is less than the pre-project curve number of 87, so detention is not needed for the 15-year storm.

**Step 2: Calculate the predevelopment and post-development peak flows.**

There are several programs available for developing runoff hydrographs. The WinTR-55 program will be used in this example. The WinTR-55 program and support materials, including the User Guide can be found here:

<https://www.nrcs.usda.gov/wps/portal/nrcs/detailfull/national/water/?cid=stelprdb1042901>

Since there is only one SDA for this site, only two model scenarios will be needed, with the following inputs/characteristics (Table I.12).

**Table I.12 TR-55 Model Scenarios for Example 2.**

Input	2- Year Predevelopment	2-Year Post-Development
Area	0.83 acre	
Curve Number	75	80
Time of Concentration <sup>1</sup>	0.1 hour	
Rainfall Depth <sup>2</sup>	3.14 inches	

1. Actual drainage characteristics (flow lengths, slopes, etc.) shall be used, but the minimum Tc must be 6 minutes (0.1 hours).
2. The NRCS Type II Storm Event shall be used.

Using these inputs, WinTR-55 can produce peak flow rates for the site (Table I.13).

**Table I.13 Peak flows for Example 2.**

	2- Year Predevelopment Peak Flow	2-Year Post-Development Peak Flow
Total	1.31 cfs	1.73 cfs

**Step 3: Determine the peak flow reduction targets.**

Table I.13 clearly shows that detention is needed on the site. Underground detention is proposed to capture runoff from the total site and reduce the peak flow. In order to reduce the total site 2-year post-development peak flow to the predevelopment rate, the 2-year post-development peak flow-in will need to be reduced from 1.73 cfs to 1.31 cfs.

**Step 4: Set up the stage-storage tables with the post-development hydrographs for the 2-year storm.**

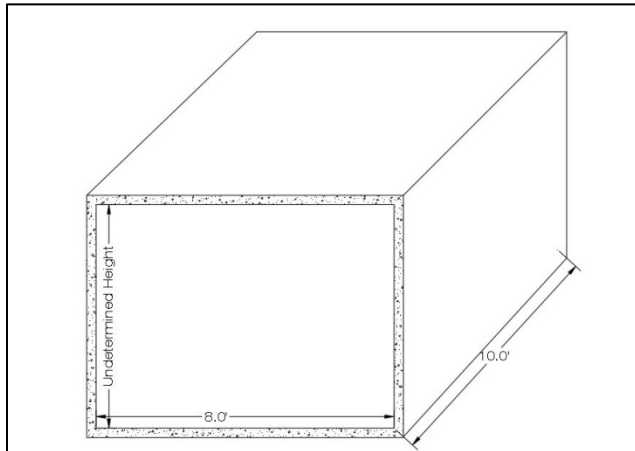
The hydrograph tables produced by WinTR-55 (Select WinTR-20 Reports → Printed Page File) can be pasted into a spreadsheet. Starting with the time increments and the flow rates from the hydrograph, a simple conversion will yield the volume of water that enters the storage tank during each time interval (Figure I.20).

$$\text{Volume of water} = (\text{Time B (hrs)} - \text{Time A (hrs)}) \times \text{Flow A (cfs)} \times 3,600 \text{ sec/hr}$$

Time (hrs)	Flow (cfs)	Volume Inflow (cf)
11.309	0.05	7.92
11.353	0.06	9.50
11.397	0.06	9.50
11.441	0.06	9.50
11.486	0.07	11.34
11.53	0.09	14.26

**Figure I.20 Spreadsheet excerpt for Example 2.**

Once the volume of water entering the storage tank per time increment is determined, a tank size and an orifice size must be assumed. This will be an iterative process to determine the smallest tank size that is sufficient to meet the detention requirements for the 2-year storm event. In this case, an 8-foot wide, 10-foot long rectangular concrete tank will be used, and the height will be modified as needed to meet the detention requirements (Figure I.21).



**Figure I.21 Detention tank for Example 2.**

The cross-sectional area for any depth of water in the tank is 80 square feet.

With the cross section of 80 square feet, the 7.92 cubic feet of water in the tank in the first time interval produces a depth of water of 0.099 feet (Figure I.22):

$$Height = \frac{Volume\ of\ Water\ in\ Tank}{Area\ of\ Tank} = \frac{7.92\ cubic\ feet}{80\ square\ feet} = 0.099\ feet$$

Time (hrs)	Flow (cfs)	Volume Inflow (cf)	Volume in Tank (cf)	Area in Tank (sf)	Depth in Tank (ft)
11.309	0.05	7.92	7.92	80.00	0.099

**Figure I.22 Spreadsheet excerpt for Example 2.**

Next, assume an orifice size. With a known depth in the tank, the outflow from the orifice is calculated based on these two equations from Appendix H.1 - Circular Orifices.

$$Q = CA(2gh)^{0.5}$$

where:

- $Q$  = orifice discharge (cfs)
- $C$  = discharge coefficient = 0.6
- $A$  = orifice cross-sectional area (ft<sup>2</sup>) =  $3.1416 \times \frac{D^2}{4}$
- $D$  = diameter of orifice (ft)
- $g$  = gravitational acceleration (32.2 ft/s<sup>2</sup>)
- $h$  = hydraulic head above the center of the orifice (ft)

When  $h < D$ , the orifice shall be treated as a weir:

$$Q = CLH^{3/2}$$

where:

- $Q$  = flow through the weir (cfs)
- $C$  = discharge coefficient = 3
- $L$  = diameter of orifice (ft)
- $H$  = hydraulic head above bottom of weir opening (ft)

Assuming a 3-inch orifice (0.25 feet), the 0.099-foot depth in the tank yields:

$$Q = CLH^{3/2} = 3 \times 0.25 \text{ ft} \times (0.099 \text{ ft})^{3/2} = 0.023 \text{ cfs}$$

The outflow in the first time interval is then used to determine the volume and depth of water in the tank in the second time interval (Figure I.23).

$$\begin{aligned} \text{Volume in Tank} &= \text{Volume from previous time interval} \\ &\quad - \text{Outflow in previous time interval} \\ &\quad + \text{Inflow in the current time interval} \end{aligned}$$

$$\text{Volume in Tank} = 7.92 \text{ cf} - 0.023 \text{ cfs} \times 0.044 \text{ hr} \times 3600 \frac{\text{sec}}{\text{hr}} + 9.50 \text{ cf} = 13.72 \text{ cf}$$



Time (hrs)	Flow (cfs)	Volume Inflow (cf)	Volume in Tank (cf)	Area in Tank (sf)	Depth in Tank (ft)	Outflow (cfs)
11.309	0.05	7.92	7.92	80.00	0.099	0.023
11.353	0.06	9.50	13.72	80.00	0.172	0.053

Figure I.23 Spreadsheet excerpt for Example 2.

At this point, the cycle repeats. The volume in the tank yields a depth calculation, which yields an orifice outflow calculation, which combines with the next inflow volume to yield a new volume in the tank. This calculation process is repeated for every time interval in the spreadsheet (Figure I.24).

Time (hrs)	Flow (cfs)	Volume Inflow (cf)	Volume in Tank (cf)	Area in Tank (sf)	Depth in Tank (ft)	Outflow (cfs)
11.309	0.05	7.92	7.92	80.00	0.099	0.023
11.353	0.06	9.50	13.72	80.00	0.172	0.053
11.397	0.06	9.50	14.79	80.00	0.185	0.060
11.441	0.06	9.50	14.85	80.00	0.186	0.060
11.486	0.07	11.34	16.47	80.00	0.206	0.070
11.53	0.09	14.26	19.63	80.00	0.245	0.091
11.574	0.13	20.59	25.78	80.00	0.322	0.134
11.618	0.18	28.51	33.10	80.00	0.414	0.152
11.662	0.29	45.94	55.01	80.00	0.688	0.196
11.707	0.38	61.56	84.87	80.00	1.061	0.243
11.751	0.55	87.12	133.46	80.00	1.668	0.305
11.795	0.73	115.63	200.77	80.00	2.510	0.374
11.839	1.04	164.74	306.22	80.00	3.828	0.462
11.883	1.53	242.35	475.34	80.00	5.942	0.576
11.928	1.73	280.26	662.28	80.00	8.279	0.680
11.972	1.6	253.44	808.01	80.00	10.100	0.751
12.016	1.46	231.26	920.31	80.00	11.504	0.802
12.06	0.9	142.56	935.89	80.00	11.699	0.808
12.104	0.5	79.20	887.05	80.00	11.088	0.787
12.149	0.36	58.32	817.88	80.00	10.224	0.756
12.193	0.31	49.10	747.29	80.00	9.341	0.722
12.237	0.28	44.35	677.23	80.00	8.465	0.688
12.281	0.26	41.18	609.50	80.00	7.619	0.652
12.326	0.24	38.88	542.70	80.00	6.784	0.616
12.37	0.22	34.85	480.06	80.00	6.001	0.579
12.414	0.21	33.26	421.62	80.00	5.270	0.543
12.458	0.19	30.10	365.79	80.00	4.572	0.505
12.502	0.18	28.51	314.26	80.00	3.928	0.468

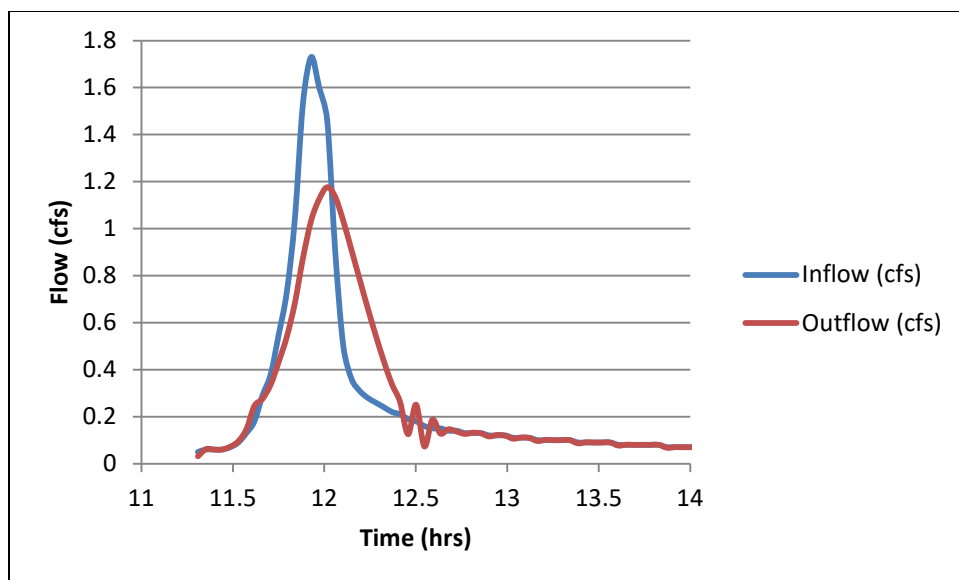
Figure I.24 Spreadsheet excerpt for Example 2.

When this is complete, the designer can determine if the storage tank is large enough such that it does not overflow (but not too large) and if the peak outflow rate is below the required target. In this case, the outflow is below the required target, however it is far below. In order to more closely meet the required flow target and reduce the required height of the tank, the orifice size can be increased to 4 inches. Increasing the orifice to 4 inches yields a new peak outflow of 1.176 cfs (Figure I.25).

Time (hrs)	Flow (cfs)	Volume Inflow (cf)	Volume in Tank (cf)	Area in Tank (sf)	Depth in Tank (ft)	Outflow (cfs)
11.309	0.05	7.92	7.92	80.00	0.099	0.031
11.353	0.06	9.50	12.49	80.00	0.156	0.062
11.397	0.06	9.50	12.22	80.00	0.153	0.060
11.441	0.06	9.50	12.27	80.00	0.153	0.060
11.486	0.07	11.34	13.88	80.00	0.173	0.072
11.53	0.09	14.26	16.69	80.00	0.209	0.095
11.574	0.13	20.59	22.19	80.00	0.277	0.146
11.618	0.18	28.51	27.56	80.00	0.345	0.246
11.662	0.29	45.94	34.58	80.00	0.432	0.275
11.707	0.38	61.56	51.52	80.00	0.644	0.337
11.751	0.55	87.12	85.34	80.00	1.067	0.433
11.795	0.73	115.63	132.31	80.00	1.654	0.540
11.839	1.04	164.74	211.52	80.00	2.644	0.683
11.883	1.53	242.35	345.70	80.00	4.321	0.873
11.928	1.73	280.26	484.50	80.00	6.056	1.034
11.972	1.6	253.44	574.18	80.00	7.177	1.125
12.016	1.46	231.26	627.17	80.00	7.840	1.176
12.06	0.9	142.56	583.40	80.00	7.292	1.134
12.104	0.5	79.20	482.90	80.00	6.036	1.032
12.149	0.36	58.32	374.01	80.00	4.675	0.908
12.193	0.31	49.10	279.24	80.00	3.491	0.785
12.237	0.28	44.35	199.29	80.00	2.491	0.663
12.281	0.26	41.18	135.48	80.00	1.694	0.546
12.326	0.24	38.88	85.85	80.00	1.073	0.435
12.37	0.22	34.85	51.83	80.00	0.648	0.338
12.414	0.21	33.26	31.63	80.00	0.395	0.263
12.458	0.19	30.10	20.01	80.00	0.250	0.125
12.502	0.18	28.51	28.71	80.00	0.359	0.251

Figure I.25 Spreadsheet excerpt for Example 2.

A peak outflow of 1.176 cfs meets the detention target of 1.31 cfs, and the maximum depth of water of 7.840 feet can be accommodated by an 8-foot tank height. With this tank design, detention requirements for the site are met (see Figure I.26).



**Figure I.26. Example 2 Inflow vs. detained outflow for 2-year storm.**

#### **I.4 HEC-1, WinTR-55, TR-20, and SWMM Computer Models**

If the application of the above computer models is needed, the complete input data file and printout will be submitted with the Stormwater Management Plans (SWMPs) at the 85% submittal stage. Submission of SWMPs shall include the following computer model documentation:

- For all computer models, supporting computations prepared for the data input file shall be submitted with the SWMPs.
- Inflow-outflow hydrographs shall be computed for each design storm presented graphically and submitted for all plans.
- Schematic (node) diagrams must be provided for all routings.

#### **I.5 Rational Method**

While this method is not recommended, as it cannot account for the retention/detention benefits of the BMPs applied on a site, this method will be permitted for use in a development of 5 acres or less. When applying this method, the following steps must be taken in the design consideration:

- In the case of more than one site sub-drainage area, the longest time of concentration shall be selected.
- Individual site sub-drainage flows shall not be summed to get the total flow for the site drainage area (SDA).

- The runoff coefficient, C, shall be a composite of the future site development conditions for all contributing areas to the discharge point. Runoff coefficient factors for typical District land uses are provided in Table I.1.
- The flow time in storm sewers shall be taken into account in computing the SDA time of concentration.
- The storm duration shall be dependent upon the SDA time of concentration.
- The storm intensity can be selected from the selected storm duration.

**Table I.1 Runoff Coefficient Factors for Typical District of Columbia Land Uses**

Zone	Predominant Use	Minimum Lot Dimensions		Runoff Coefficient C
		Width (ft)	Area (ft <sup>2</sup> )	
R-1-A	One-family detached dwelling	75	7,500	0.60
R-1-B	One-family detached dwelling	50	5,000	0.65
R-2	One-family semi-detached dwelling	30	3,000	0.65
R-3	Row dwelling	20	2,000	0.70
RF-1	Row dwelling	18	1,800	0.75
RA-1	Low density apartment	–	–	0.70
RA-2	Medium density apartment house	–	–	0.75
RA-3	Medium high density apartment house	–	–	0.80
RA-5	High density building	–	–	0.80
C	Commercial	–	–	0.85–0.95
M	General Industry	–	–	0.80–0.90
Park	Open green space	–	–	0.35

## I.6 Stormwater Volume Peak Discharge

The peak rate of discharge for individual design storms may be required for several different components of water quality BMP design. While the primary design and sizing factor for most stormwater retention BMPs is the design SWR<sub>v</sub>, several design elements will require a peak rate of discharge for specified design storms. The design and sizing of pretreatment cells, level spreaders, by-pass diversion structures, overflow riser structures, grass swales, water quality swale geometry, etc., all require a peak rate of discharge in order to ensure non-erosive conditions and flow capacity.

The peak rate of discharge from a SDA can be calculated from any one of several calculation methods discussed in this appendix. The two most commonly used methods of computing peak

discharges for peak runoff calculations and drainage system design are NRCS TR-55 CN methods (NRCS TR-55, 1986) and the Rational Formula. The Rational Formula is highly sensitive to the time of concentration and rainfall intensity, and therefore should only be used with reliable Intensity-Duration-Frequency (IDF) curves or tables for the rainfall depth and region of interest (Clayton and Schueler, 1996). Unfortunately, there are no IDF curves available at this time for the 1.2-inch rainfall depth.

The NRCS CN methods are very useful for characterizing complex sub-watersheds and SDAs and estimating the peak discharge from large storms (greater than 2 inches), but can significantly underestimate the discharge from small storm events (Clayton and Schueler, 1996). Since the SWR<sub>v</sub> is based on a 1.2-inch rainfall, this underestimation of peak discharge can lead to undersized diversion and overflow structures, potentially bypassing a significant volume of the design SWR<sub>v</sub> around the retention practice. Undersized overflow structures and outlet channels can cause erosion of the BMP conveyance features that can lead to costly and frequent maintenance.

In order to maintain consistency and accuracy, the following Modified CN Method is recommended to calculate the peak discharge for the SWR<sub>v</sub> 1.2-inch rain event. The method utilizes the Small Storm Hydrology Method (Pitt, 1994) and NRCS Graphical Peak Discharge Method (USDA, 1986) to provide an adjusted CN that is more reflective of the runoff volume from impervious areas within the SDA. The design rainfall is a NRCS type II distribution so the method incorporates the peak rainfall intensities common in the eastern United States, and the time of concentration is computed using the method outlined in TR-55.

The following steps describe how to calculate the SWR<sub>v</sub> peak rate of discharge ( $q_{pSWRv}$ ):

**Step 1: Calculate the adjusted CN for the site or contributing drainage area (CDA).**

The following equation is derived from the NRCS CN Method and is described in detail in the National Engineering Handbook Chapter 4: Hydrology (NEH-4), and NRCS TR-55 Chapter 2: Estimating Runoff:

$$CN = \frac{1,000}{[10 + 5P + 10Q_a - 10(Q_a^2 + 1.25Q_aP)^{0.5}]}$$

where:

- $CN$  = adjusted curve number
- $P$  = rainfall (in.), (1.2 in.)
- $Q_a$  = runoff volume (watershed inches), equal to SWR<sub>v</sub> divided by CDA

Note: When using hydraulic/hydrologic model for sizing a retention BMP or calculating the SWR<sub>v</sub> peak discharge, designers must use this modified CN for the CDA to generate runoff equal to the SWR<sub>v</sub> for the 1.2-inch rainfall event.

**Step 2: Compute the CDA Time of Concentration ( $T_c$ ).**

TR-55 Chapter 3: Time of Concentration and Travel Time provides a detailed procedure for computing the  $T_c$ .

**Step 3: Calculate the Stormwater Retention Volume peak discharge ( $qp_{SWRV}$ )**

The  $qp_{SWRV}$  is computed using the following equation and the procedures outlined in TR-55, Chapter 4: Graphical Peak Discharge Method. Designers can also use WinTR-55 or an equivalent TR-55 spreadsheet to compute  $qp_{SWRV}$ :

- Read initial abstraction ( $I_a$ ) from TR-55 Table 4.1 or calculate using  $I_a = 200/CN - 2$
- Compute  $I_a/P$  ( $P = 1.2$ )
- Read the Unit Peak Discharge ( $q_u$ ) from exhibit 4-II using  $T_c$  and  $I_a/P$
- Compute the  $qp_{SWRV}$  peak discharge:

$$qp_{SWRV} = \frac{q_u \times A \times Q_a}{27,878,400}$$

where:

$qp_{SWRV}$	=	Stormwater Retention Volume peak discharge (cfs)
$q_u$	=	unit peak discharge (cfs/mi <sup>2</sup> /in.)
$A$	=	contributing drainage area (ft <sup>2</sup> )
$Q_a$	=	runoff volume (watershed inches = $SWRV/A$ )
27,878,400	=	conversion from square miles to square feet

This procedure is for computing the peak flow rate for the 1.2-inch rainfall event. All other calculations of peak discharge from larger storm events for the design of drainage systems, culverts, etc., should use published CNs and computational procedures.

## I.7 References

Claytor, R. and T. Schueler. 1996. Design of Stormwater Filtering Systems. Chesapeake Research Consortium and the Center for Watershed Protection. Ellicott City, MD.  
<https://owl.cwp.org/>

Pitt, R., 1994, Small Storm Hydrology. University of Alabama - Birmingham. Unpublished manuscript. Presented at design of stormwater quality management practices. Madison, WI, May 17-19 1994.

“Precipitation-Frequency Atlas of the United States” NOAA Atlas 14, Volume 2, Version 3.0, G. M. Bonnin, D. Martin, B. Lin, T. Parzybok, M. Yekta, and D. Riley, NOAA, National Weather Service, Silver Spring, Maryland, 2006. <https://hdsc.nws.noaa.gov/hdsc/pfds/>

United States Army Corps of Engineers. “Hydrologic Modeling System (HEC-HMS).”  
<https://www.hec.usace.army.mil/software/hec-hms/>

United States Department of Agriculture Natural Resources Conservation Service. “WinTR-55.”  
<https://www.nrcs.usda.gov/wps/portal/nrcs/detailfull/national/water/?cid=stelprdb1042901>

United States Department of Agriculture Natural Resources Conservation Service. “WinTR-20.”  
<http://go.usa.gov/cZeg9>

United States Department of Agriculture Natural Resources Conservation Service Urban Hydrology for Small Watersheds TR-55. June 1986.

U.S. Environmental Protection Agency. “Storm Water Management Model (SWMM).”  
<https://www.epa.gov/water-research/storm-water-management-model-swmm>

Virginia Department of Conservation and Recreation DRAFT 2009 Virginia Stormwater Management Handbook. September 2009.





# Appendix J Rooftop Storage Design Guidance and Criteria

Rooftop storage, as described in this appendix, is intended as a detention practice only. The rules and guidelines presented in this appendix do not apply to green roofs (Section 3.2 Green Roofs).

1. Rooftop storage may be used to provide detention for the 2-year and 15-year storms, as applicable. Detention calculations must follow the procedures identified in Chapter 2, “Minimum Control Requirements” and Appendix I - - Acceptable Hydrologic Methods and Models.
2. Rainfall from the 2-year, 24-hour storm results in an accumulated rainfall of approximately 3.2 inches and rainfall from the 15-year, 24-hour storm results in an accumulated rainfall of approximately 5.2 inches. Peak flow detention calculations for either of these storms will require less than these depths (assuming there is no run-on from other rooftop areas).
  - (a) Based on a snow load of 30 pounds per square foot or 5.8 inches of water, properly designed roofs must be structurally capable of holding the required detention volume with a reasonable factor of safety.
  - (b) Roofs calculated to store depths greater than 3 inches shall be required to show structural adequacy of the roof design.
3. No less than two roof drains shall be installed in roof areas of 10,000 square feet or less, and at least four drains shall be installed in roof areas over 10,000 square feet in area. Roof areas exceeding 40,000 square feet shall have one drain for each 10,000-square-foot area.
4. Emergency overflow measures adequate to discharge the 100-year, 45-minute storm must be provided.
  - (a) If parapet walls exceed 5 inches in height, the designer shall provide openings (scuppers) in the parapet wall sufficient to discharge the design storm flow at a water level not exceeding 5 inches.
  - (b) One scupper shall be provided for every 20,000 square feet of roof area, and the invert of the scupper shall not be more than 5 inches above the roof level. If such openings are not practical, then detention rings shall be sized accordingly.
5. Detention rings shall be placed around all roof drains that do not have controlled flow (see Figures J.1 and J.2).
  - (a) The number of holes or size of openings in the rings shall be computed based on the area of roof drained and runoff criteria.
  - (b) The minimum spacing of sets of holes is 2 inches center-to-center.
  - (c) The height of the ring is determined by the roof slope and detention requirements and shall be 5 inches maximum.

- (d) The diameter of the rings shall be sized to accommodate the required openings and, if scuppers are not provided, to allow the 100-year design storm to overtop the ring (overflow design is based on weir computations with the weir length equal to the circumference of the detention ring).
  - (e) Conductors and leaders shall also be sized to pass the expected flow from the 100-year design storm.
6. The maximum time of drawdown on the roof shall not exceed 17 hours.
  7. Josam Manufacturing Company and Zurn Industries, Inc. market “controlled-flow” roof drains. These products, or their equivalent, are acceptable.
  8. Computations required on plans:
    - (a) Roof area in square feet.
    - (b) Storage provided at design depth.
    - (c) Maximum allowable discharge rate.
    - (d) Inflow-outflow hydrograph analysis or acceptable charts (for Josam Manufacturing Company and Zurn Industries, Inc. standard drains, the peak discharge rates as given in their charts are acceptable for drainage calculation purposes without requiring full inflow-outflow hydrograph analysis).
    - (e) Number of drains required.
    - (f) Sizing of openings required in detention rings.
    - (g) Sizing of ring to accept openings and to pass 100-year design storm.

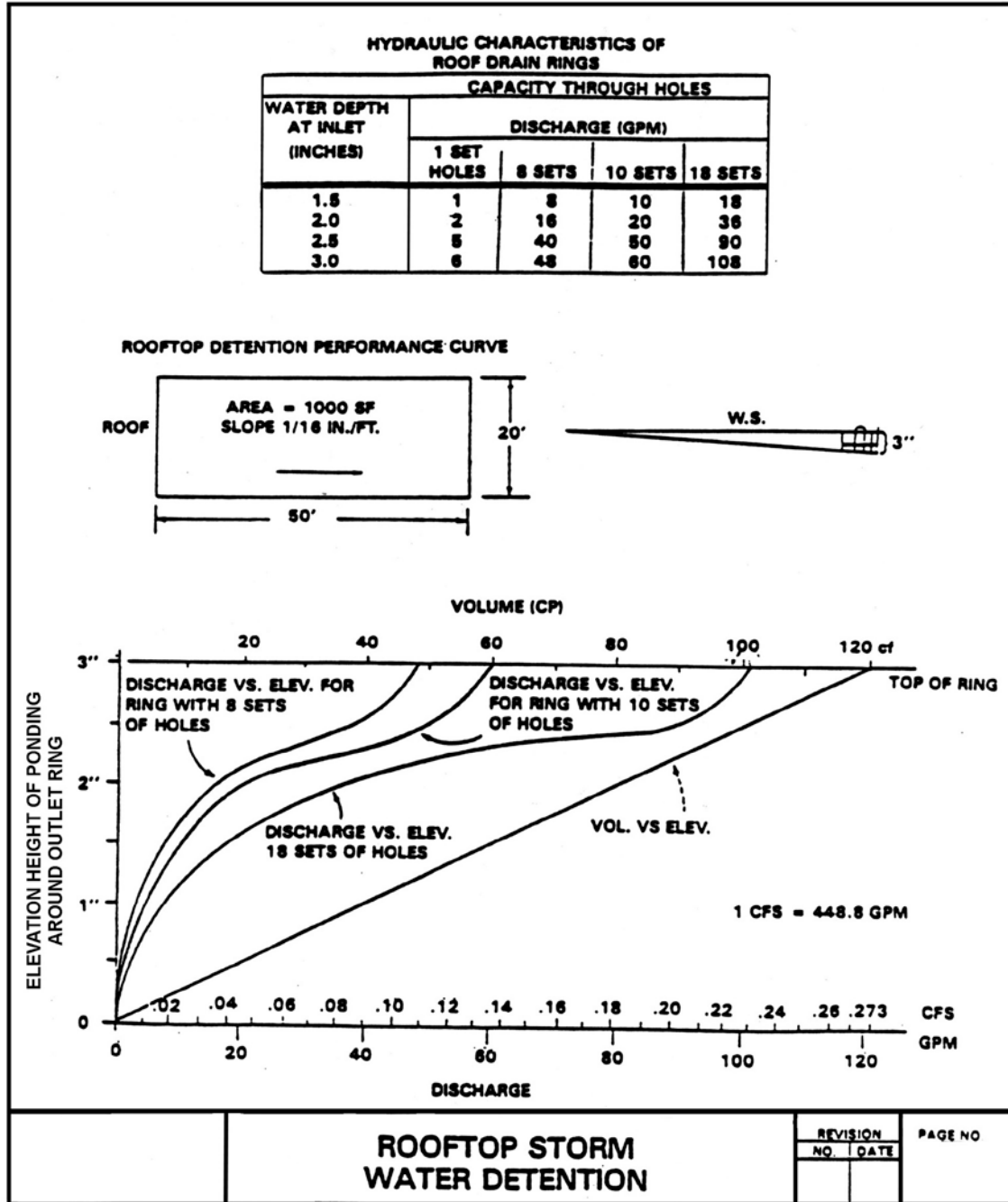


Figure J.1 Rooftop stormwater detention.

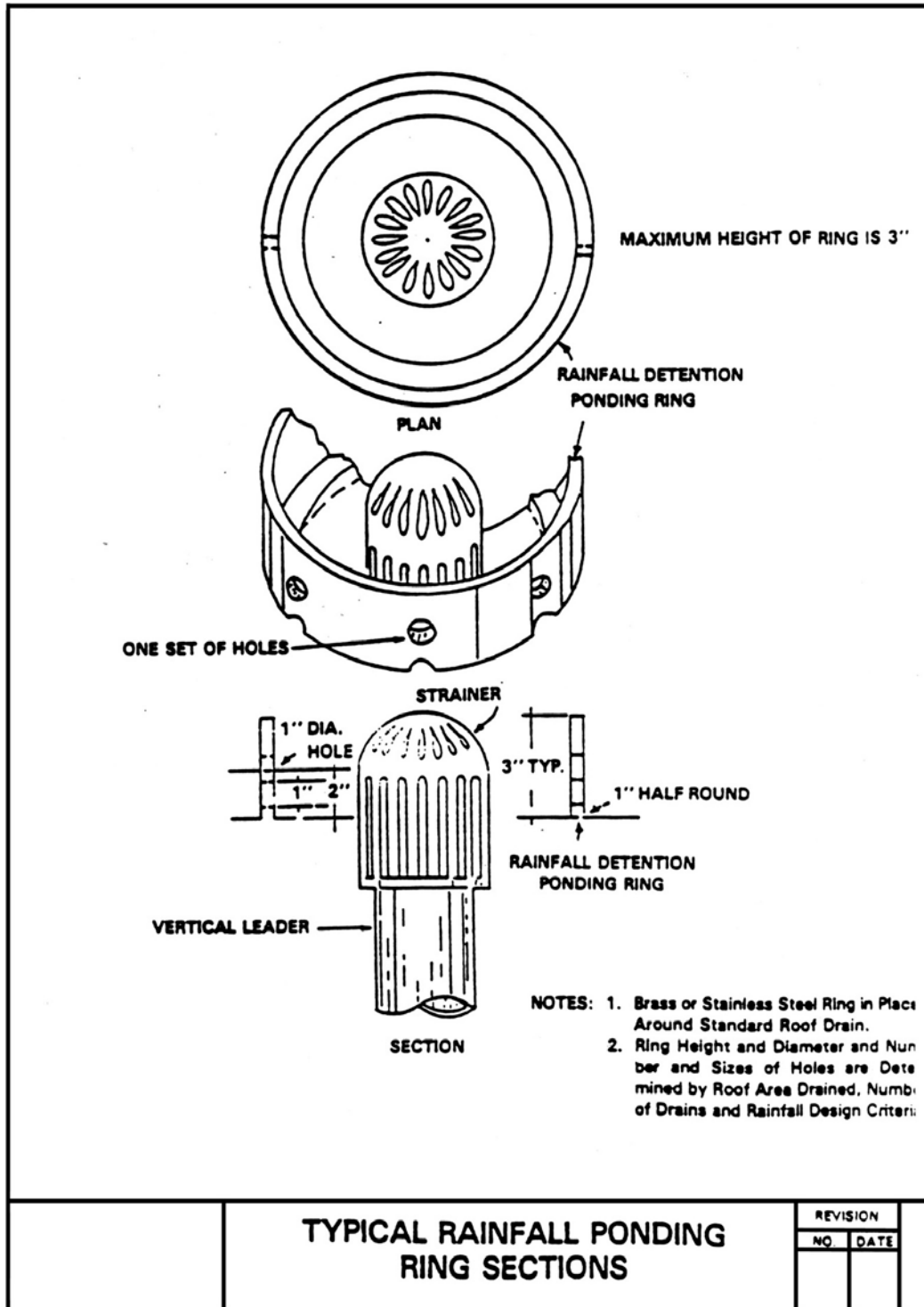


Figure J.2 Typical rainfall ponding ring sections.

# Appendix K Soil Compost Amendment Requirements

## K.1 Introduction

Soil amendment (also called soil restoration) is a technique applied after construction to deeply till compacted soils and restore their porosity by amending them with compost. These soil amendments can be used to enhance the performance of impervious cover disconnections and grass channels.

## K.2 Physical Feasibility and Design Applications

Amended soils are suitable for any pervious area where soils have been or will be compacted by the grading and construction process. They are particularly well suited when existing soils have low infiltration rates (hydrologic soil group (HSG) C and D) and when the pervious area will be used to filter runoff (downspout disconnections and grass channels). The area or strip of amended soils should be hydraulically connected to the stormwater conveyance system. Soil restoration is recommended for sites that will experience mass grading of more than a foot of cut and fill across the site. Amendments should be applied to achieve a minimum organic matter content of 5%.

Compost amendments are not recommended where any of the following exists:

- Existing soils have high infiltration rates (e.g., HSG A and B), although compost amendments may be needed at mass-graded B soils in order to maintain infiltration rates.
- The water table is located within 1.5 feet of the soil surface.
- Slopes exceed 10% (compost can be used on slopes exceeding 10% as long as proper soil erosion and sediment control measures are included in the plan).
- Existing soils are saturated or seasonally wet.
- They would harm roots of existing trees (keep amendments outside the tree drip line).
- The downhill slope runs toward an existing or proposed building foundation.
- Areas that will be used for snow storage.

## K.3 Design Criteria

**Performance When Used in Conjunction with Other Practices.** As referenced in several of the Chapter 3 Stormwater Best Management Practices (BMPs) specifications, soil compost amendments can be used to enhance the performance of allied practices by improving runoff infiltration. The specifications for each of these practices contain design criteria for how compost amendments can be incorporated into those designs:

- Impermeable Surface Disconnection – See Section 3.4 Impervious Surface Disconnection.
- Grass Channels –See Section 3.9, Open Channel Systems.”

**Soil Testing.** Soil tests are required during two stages of the compost amendment process. The first testing is done to ascertain preconstruction soil properties at proposed amendment areas. The initial testing is used to determine soil properties to a depth 1 foot below the proposed amendment area, with respect to bulk density, pH, salts, and soil nutrients. These tests should be conducted every 5,000 square feet, are used to characterize potential drainage problems, and determine what, if any, further soil amendments are needed.

The second soil test is taken at least 1 week after the compost has been incorporated into the soils. This soil analysis should be conducted by a reputable laboratory to determine whether any further nutritional requirements, pH adjustment, and organic matter adjustments are necessary for plant growth. This soil analysis must be done in conjunction with the final construction inspection to ensure tilling or subsoiling has achieved design depths.

**Determining Depth of Compost Incorporation.** The depth of compost amendment is based on the relationship of the surface area of the soil amendment to the contributing area of impervious cover that it receives. Table K.1 presents some general guidance derived from soil modeling by Holman-Dodds (2004) that evaluates the required depth to which compost must be incorporated. Some adjustments to the recommended incorporation depth were made to reflect alternative recommendations of Roa Espinosa (2006), Balousek (2003), Chollak and Rosenfeld (1998), and others.

**Table K.1 Method to Determine Compost and Incorporation Depths**

Ratio of Area of Contributing Impervious Cover to Soil Amendment <sup>a</sup> (IC/SA)	Average Compost Depth (in.)	Incorporation Depth (in.)	Incorporation Method
0.5	3	12	Tiller
0.75	4	18	Subsoiler
1.0 <sup>b</sup>	6	24	Subsoiler

<sup>a</sup> IC = contributing impervious cover (ft<sup>2</sup>) and SA = surface area of compost amendment (ft<sup>2</sup>)

<sup>b</sup> In general, IC/SA ratios greater than 1 should be avoided

Once the area and depth of the compost amendments are known, the designer can estimate the total amount of compost needed, using an estimator developed by TCC, (1997):

$$C = A \times D \times 0.0031$$

where:

- $C$  = compost needed (yd<sup>3</sup>)
- $A$  = area of soil amended (ft<sup>2</sup>)
- $D$  = depth of compost added (in.)

**Compost Specifications.** The basic material specifications for compost amendments are outlined below:

- Compost shall be derived from plant material and provided by a member of the U.S. Composting Seal of Testing Assurance (STA) program. See <https://compostingcouncil.org/> for a list of local providers.
- Alternative specifications and/or certifications, such as those administered by the Maryland Department of Agriculture or other agencies, may be substituted, as authorized by DOEE. In all cases, compost material must meet standards for chemical contamination and pathogen limits pertaining to source materials, as well as reasonable limits on phosphorus and nitrogen content to avoid excessive leaching of nutrients.
- The compost shall be the result of the biological degradation and transformation of plant-derived materials under conditions that promote aerobic decomposition. The material shall be well composted, free of viable weed seeds, and stable with regard to oxygen consumption and carbon dioxide generation. The compost shall have a moisture content that has no visible free water or dust produced when handling the material. It shall meet the following criteria, as reported by the U.S. Composting Council STA Compost Technical Data Sheet provided by the vendor:
  - (a) 100% of the material must pass through a half-inch screen
  - (b) The pH of the material shall be between 6 and 8
  - (c) Manufactured inert material (plastic, concrete, ceramics, metal, etc.) shall be less than 1.0% by weight
  - (d) The organic matter content shall be between 35%–65%
  - (e) Soluble salt content shall be less than 6.0 mmhos/cm
  - (f) Maturity must be greater than 80%
  - (g) Stability shall be 7 or less
  - (h) Carbon/nitrogen ratio shall be less than 25:1
  - (i) Trace metal test result = “pass”
  - (j) The compost must have a dry bulk density ranging from 40 to 50 lb/ft<sup>3</sup>

#### **K.4 Construction Sequence**

The construction sequence for compost amendments differs depending whether the practice will be applied to a large area or a narrow filter strip, such as in a rooftop disconnection or grass channel. For larger areas, a typical construction sequence is as follows:

**Step 1: Soil Erosion and Sediment Control.** When areas of compost amendments exceed 2,500 square feet, install soil erosion and sediment control measures, such as silt fences, to secure the area until the surface is stabilized by vegetation.

**Step 2: Deep Till.** Deep till to a depth of 12 to 18 inches after the final building lots have been graded prior to the addition of compost.

**Step 3: Dry Conditions.** Wait for dry conditions at the site prior to incorporating compost.

**Step 4: Compost.** Incorporate the required compost depth (as indicated in Table J.1) into the tilled soil using the appropriate equipment.

**Step 5: Level the site.** Seeds or sod are required to establish a vigorous grass cover. To help the grass grow quickly, lime or irrigation is recommended.

**Step 6: Vegetation.** Ensure surface area is stabilized with vegetation.

**Step 7: Construction Inspection.** Construction inspection by a qualified professional involves digging a test pit to verify the depth of amended soil and scarification. A rod penetrometer should be used to establish the depth of uncompacted soil at a minimum of 1 location per 10,000 square feet.

## **K.5 Maintenance**

**First-Year Maintenance Operations.** In order to ensure the success of soil compost amendments, the following tasks must be undertaken in the first year following soil restoration:

- **Initial inspections.** For the first 6 months following the incorporation of soil amendments, the site should be inspected by a qualified professional at least once after each storm event that exceeds 1/2-inch of rainfall.
- **Spot Reseeding.** Inspectors should look for bare or eroding areas in the contributing drainage area (CDA) or around the soil restoration area and make sure they are immediately stabilized with grass cover.
- **Fertilization.** Depending on the amended soils test, a one-time, spot fertilization may be needed in the fall after the first growing season to increase plant vigor.
- **Watering.** Water once every 3 days for the first month and then weekly during the first year (April through October), depending on rainfall.

**Ongoing Maintenance.** There are no major ongoing maintenance needs associated with soil compost amendments, although the owners may want to de-thatch the turf every few years to increase permeability. The owner should also be aware that there are maintenance tasks needed for filter strips, grass channels, and reforestation areas. DOEE's maintenance inspection checklist for an area of Soil Compost Amendments can be accessed in Appendix M - Maintenance Inspection Checklists.

**Declaration of Covenants.** A maintenance covenant is required for all stormwater management practices. The covenant specifies the property owner's primary maintenance responsibilities, and authorizes DOEE staff to access the property for inspection or corrective action in the event the proper maintenance is not performed. The covenant is recorded in the District of Columbia land records (see standard form, variations exist for scenarios where stormwater crosses property lines). The covenant is between the property and the Government of the District of Columbia. It is submitted through the Office of the Attorney General. All SWMPs have a maintenance agreement stamp that must be signed for a building permit to proceed. There may be a



maintenance schedule on the drawings themselves or the plans may refer to the maintenance schedule (Exhibit C in the covenant).

Covenants are not required on government properties, but maintenance responsibilities must be defined through a partnership agreement or a memorandum of understanding.

## **K.6 References**

Balusek. 2003. Quantifying decreases in stormwater runoff from deep-tilling, chisel-planting and compost amendments. Dane County Land Conservation Department. Madison, Wisconsin.

Chollak, T. and P. Rosenfeld. 1998. Guidelines for Landscaping with Compost-Amended Soils. City of Redmond Public Works. Redmond, WA. Available online at:  
<http://www.redmond.gov/common/pages/UserFile.aspx?fileId=14766>

The Composting Council (TCC). 1997. Development of a Landscape Architect Specification for Compost Utilization. Alexandria, VA. <http://infohouse.p2ric.org/ref/13/12551.pdf>

Holman-Dodds, L. 2004. Chapter 6. Assessing Infiltration-Based Stormwater Practices. PhD Dissertation. Department of Hydroscience and Engineering. University of Iowa. Iowa City, IA.

Low Impact Development Center. 2003. Guideline for Soil Amendments.

Roa-Espinosa. 2006. An Introduction to Soil Compaction and the Subsoiling Practice. Technical Note. Dane County Land Conservation Department. Madison, Wisconsin



# Appendix L Construction Inspection Checklists

Inspections before, during, and after construction are required to ensure that Stormwater Management Plans (SWMPs) are built in accordance with the approved plan. Inspectors will use detailed inspection checklists that require sign-offs by qualified individuals at critical stages of construction to ensure the contractor's interpretation of the plan is consistent with the designer's intent.

This appendix includes the following construction phase inspection checklists (see Figures L.1 through L.13):

- Green Roof Construction Inspection Report
- Rainwater Harvesting Construction Inspection Report
- Impervious Surface Disconnection Construction Inspection Report
- Permeable Pavement System Construction Inspection Report
- Bioretention Construction Inspection Report
- Sand Filter Construction Inspection Report
- Infiltration Device Construction Inspection Report
- Open Channel System Construction Inspection Report
- Pond, Wetland, and Storage Practices Construction Inspection Report
- Stormwater Management Facilities Inspection Report
- Tree Planting and Preservation Construction Inspection Report
- Stormwater Management Standard Testing Record
- Green Area Ratio Landscape Checklist

The checklists are subject to change with the latest versions available at <https://doee.dc.gov/swguidebook>

**GOVERNMENT OF THE DISTRICT OF COLUMBIA**  
 Department of Energy and Environment



Construction and Maintenance Branch  
**Green Roof Construction Inspection Report**

Building Permit #: \_\_\_\_\_ Plan #: \_\_\_\_\_ Lot: \_\_\_\_\_ Square: \_\_\_\_\_

Project Address: \_\_\_\_\_ Ward: \_\_\_\_\_

Contractor: \_\_\_\_\_ Email: \_\_\_\_\_

Engineer: \_\_\_\_\_ Email: \_\_\_\_\_

Date Started: \_\_\_\_\_ Final Inspection Date: \_\_\_\_\_ As-Built Plan Due Date: \_\_\_\_\_

Green Roof Type: Extensive \_\_\_\_\_ Intensive \_\_\_\_\_ New Construction \_\_\_\_\_ Retrofit of Existing Roof \_\_\_\_\_

Inspection Item	No	Yes	Remarks	Date
<p><b>Green Roof Components:</b></p> <p>Roof/deck type:                      ___ Concrete ___ Metal ___ Wood ___ Other (specify):  <i>Note: Certain roof materials, such as exposed treated wood and uncoated galvanized metal, may not be appropriate for green rooftops due to pollutant leaching through the media.</i></p> <p>Is adequate waterproofing layer(s) provided?                      Identify type of system  <input type="checkbox"/> Tray system  <input type="checkbox"/> Built in place system  <input type="checkbox"/> Other _____ (Specify)</p> <p>Do the root barrier, insulation, moisture retention layer, filter fabric, and drainage layers meet plan specifications? (<i>Attach invoice and manufactures' certifications</i>)</p> <p>Does the growing media meet plan specifications? Verify depth of growing material. (<i>Attach invoice and manufacturer's certifications.</i>)</p> <p>Does the vegetation layer meet plan specifications? (species mixture, coverage)                      Verify vegetation source—  <input type="checkbox"/> Plugs  <input type="checkbox"/> Seeds  <input type="checkbox"/> Pre grown mat.  <input type="checkbox"/> Other _____ (Specify)                      (<i>Attach invoice and laboratory certification.</i>)</p> <p>Does the metal curbing and flashing meet plan specifications? (<i>Attach invoice and manufacturer's certifications.</i>)</p> <p>Do pedestals and pavers and non-vegetated areas meet plan specifications (type and location)?</p>				



2000 First Street NE, 5th Floor, Washington, DC 20002 | (202) 535-2600 | doee.dc.gov



**Figure L.1 Green Roof Construction Inspection Report.**

Inspection Item	No	Yes	Remarks	Date
<b>Water Source:</b> <input type="checkbox"/> Irrigation system <input type="checkbox"/> Hose bib <input type="checkbox"/> Other _____(Specify) Is there a post-construction leak detection device?				
<b>Solar Panels and Other Structures (if applicable):</b> Are solar panels present? Are they installed in accordance with the plan? Is there 3 feet of separation between rows of panels? Is the lower edge of the panels at least 1 foot above the top of the green roof and the upper edge at least 2.5 feet above the top of the green roof? Are structures above the green roof 6.5 feet wide or less?				
<b>Plantings and Housekeeping:</b> Do plants meet size and variety specifications? Have all planting waste materials, and construction trash and debris been pickup and removed from the roof?				
<b>Maintenance Plan:</b> Is an approved maintenance plan provided to the person responsible for maintenance/owner?				

Owner/ Agent \_\_\_\_\_ Inspector \_\_\_\_\_ Date \_\_\_\_\_

Figure L.1 (continued)

**GOVERNMENT OF THE DISTRICT OF COLUMBIA**  
Department of Energy and Environment



Construction and Maintenance Branch  
**Rainwater Harvesting Construction Inspection Report**

Building Permit # \_\_\_\_\_ Plan and File # \_\_\_\_\_ Lot: \_\_\_\_\_ Square: \_\_\_\_\_  
 Project Name and Address: \_\_\_\_\_ Ward: \_\_\_\_\_  
 Contractor: \_\_\_\_\_ Email \_\_\_\_\_  
 Engineer: \_\_\_\_\_ Email \_\_\_\_\_  
 Responsible For Maintenance: \_\_\_\_\_ Email \_\_\_\_\_  
 Date Started: \_\_\_\_\_ Final Inspection Date: \_\_\_\_\_ As-Built Plan Due Date: \_\_\_\_\_

Inspection Items	Yes	No	Remarks	Date Completed
<b>Contributing Drainage Area:</b> Does the rooftop area draining to the tank match the plans?				
<b>Conveyance:</b> Do the gutters and downspouts meet specifications with the correct sizing, elevation, and slope?				
<b>Pretreatment</b> Is there pretreatment mechanism installed? Check all that apply: <input type="checkbox"/> First flush diverter <input type="checkbox"/> Hydrodynamic separator <input type="checkbox"/> Roof washer <input type="checkbox"/> Leaf and mosquito screen (1 mm mesh) <input type="checkbox"/> Other:				
<b>Pump System (where Applicable):</b> Has the pump and piping to end-uses (indoor, outdoor irrigation, or tank dewatering release) been properly installed? (A copy of plumbing sign off may be needed.) Is a treatment process/system installed? Check all that apply and provide type/process: <input type="checkbox"/> Filtration <input type="checkbox"/> Disinfection: Type: _____ <input type="checkbox"/> Other:				
<b>Overflow System:</b> Overflow device is directed as shown on plans Catchment area and overflow area are stabilized Secondary stormwater treatment practice(s) (if applicable) is installed as shown on plans				
<b>Final Inspection:</b> Is water conveyed into tank and to end-uses appropriately? Has the system been commissioned? Include documentation of commissioning.				

Owner/ Agent \_\_\_\_\_ Inspector \_\_\_\_\_ Date \_\_\_\_\_



1200 First Street NE, 5th Floor, Washington, DC 20002 | (202) 535-2600 | doee.dc.gov



**Figure L.2 Rainwater Harvesting Construction Inspection Report.**

**GOVERNMENT OF THE DISTRICT OF COLUMBIA**  
 Department of Energy and Environment



Construction and Maintenance Branch

**Impervious Surface Disconnection Construction Inspection Report**

Building Permit #: \_\_\_\_\_ Plan #: \_\_\_\_\_ Lot: \_\_\_\_\_ Square: \_\_\_\_\_

Project Address: \_\_\_\_\_ Ward \_\_\_\_\_

Contractor: \_\_\_\_\_ Email: \_\_\_\_\_

Engineer: \_\_\_\_\_ Email: \_\_\_\_\_

Responsible for Maintenance: \_\_\_\_\_ Email: \_\_\_\_\_

Disconnection Type: Simple \_\_\_\_\_ Dry Well \_\_\_\_\_ Rain Garden \_\_\_\_\_ Other \_\_\_\_\_

Date Started: \_\_\_\_\_ Final Inspection Date: \_\_\_\_\_ As-Built Plan Due Date: \_\_\_\_\_

Inspection Items	Yes	No	Remarks	Date
<b>Site Preparation:</b>				
Have erosion and sediment controls been properly installed and maintained according to approved plans?				
Do site excavation and grading conform to the site plans?				
Has the pervious receiving area avoided compaction during excavation?				
<b>Contributing Drainage Area:</b>				
Does the impervious area draining to the receiving pervious area match the plans?				
<b>Practice Geometry:</b>				
Does the receiving pervious area match the dimensions and slopes shown on the plan?				
Has a secondary practice been installed according to plan (if required)?				
<b>Vegetation:</b>				
Does the pervious area vegetation comply with the approved planting plan and specification?				
Topsoil mixture, soil amendments, and soil compaction comply with plan (if required)				
<b>Final Inspection:</b>				
Have the contributing impervious area and the receiving pervious area been stabilized?				
Can water flow properly into the receiving pervious area?				

Owner/ Agent \_\_\_\_\_ Inspector \_\_\_\_\_ Date \_\_\_\_\_



1200 First Street NE, 5th Floor, Washington, DC 20002 | (202) 535-2600 | doee.dc.gov



**Figure L.3 Impervious Surface Disconnection Construction Inspection Report.**

**GOVERNMENT OF THE DISTRICT OF COLUMBIA**  
Department of Energy and Environment



Construction and Maintenance Branch

**Permeable Pavement - CONSTRUCTION INSPECTION REPORT**

Building Permit # \_\_\_\_\_ Plan and File # \_\_\_\_\_ Lot: \_\_\_\_\_ Square: \_\_\_\_\_  
 Project Address: \_\_\_\_\_ Ward: \_\_\_\_\_  
 Contractor: \_\_\_\_\_ Email \_\_\_\_\_  
 Engineer: \_\_\_\_\_ Email \_\_\_\_\_  
 Responsible For Maintenance: \_\_\_\_\_ Email \_\_\_\_\_  
 Date Started: \_\_\_\_\_ Final Inspection Date: \_\_\_\_\_ As-Built Plan Due Date: \_\_\_\_\_

Inspection Items	Yes	No	Remarks	Date Completed
<b>Permeable pavement type: __ Standard __ Enhanced</b>				
<b>Site Preparation:</b>				
Have erosion and sediment controls been properly installed according to approved plans?				
Is storm water runoff being diverted around the facility?				
Has the contributing drainage area been fully stabilized?				
<b>Subgrade Preparation:</b>				
Is subgrade suitable free of debris, standing water, properly graded?				
If enhanced design (for infiltration), is subgrade compaction avoided?				
<b>Filter Layer or Filter Fabric (where Applicable):</b>				
Does the filter layer and/or filter fabric meet the specifications and is it installed according to the plan specifications?				
<b>Underdrain and Reservoir Layer:</b>				
Does the underdrain meet specifications with correct hole pattern, elevation, slope, size, and number?				
Are caps placed on the upstream (but not the downstream) ends of the underdrains ?				
Is the upstream end of the underdrain capped?				
Does the stone reservoir meet specifications (clean, washed, free of fines) and is it installed to design depth?				
Is at least 2 inches of aggregate provided above and (for standard design) a maximum of 2 inches below the underdrains?				
<b>Surface Material:</b>				
Does the surface material meet the specification and has it been properly installed?				
Is the surface slope to spec (max 5%) and can runoff spread evenly across it?				
Has the surface material had adequate curing time (for Porous Asphalt and Pervious Concrete)?				
Is the surface free of fines and areas of clogging?				



1200 First Street NE, 5th Floor, Washington, DC 20002 | (202) 535-2600 | doee.dc.gov



**Figure L.4 Permeable Pavement System Construction Inspection Report.**



<b>Over Flow Drain (where Applicable):</b> Is overflow invert at correct elevation?				
<b>Observation Well:</b> Is observation well(s) placed per plan specification?				
<b>Setback:</b> If facility is within 10 feet of property line/building, is adequate waterproofing protection provided?				
<b>Final Inspection:</b> Observation well(s)/cleanout(s) free of construction debris and sediment? Can water infiltrate properly into the practice?				

**Note:** Material invoices and certifications should be submitted to show conformance to specifications.

Owner/Agent \_\_\_\_\_ Inspector \_\_\_\_\_ Date \_\_\_\_\_

**Figure L.5 (continued)**

**GOVERNMENT OF THE DISTRICT OF COLUMBIA**  
 Department of Energy and Environment



Construction and Maintenance Branch

**Bioretention Construction Inspection Report**

Building Permit #: \_\_\_\_\_ Plan and File#: \_\_\_\_\_ Lot: \_\_\_\_\_ Square: \_\_\_\_\_

Project Address: \_\_\_\_\_ Ward: \_\_\_\_\_

Contractor: \_\_\_\_\_ Email: \_\_\_\_\_

Engineer: \_\_\_\_\_ Email: \_\_\_\_\_

Responsible For Maintenance: \_\_\_\_\_ Email: \_\_\_\_\_

Date Started: \_\_\_\_\_ Final Inspection Date: \_\_\_\_\_ As-Built Plan Due Date: \_\_\_\_\_

Inspection Items	Yes	No	Remarks	Date
<b>Bioretention type :</b> Standard _____ Enhanced _____ : Online _____ Offline _____  <b>Inflow/Overflow:</b> Are inflow/overflow/outflow inverts at the correct elevations? Is stormwater runoff being diverted around practice during construction (if possible)?  Is adequate erosion and sediment control measure(s) placed/installed around the bioretention?  Is inflow pipe to practice covered with filter fabric to prevent debris from entering? Is pretreatment provided per the approved plan ? Is ponding depth per design (3 inches minimum, 18 inches maximum)?				
<b>Grading:</b> Has bioretention area been graded as indicated in the plan? If design includes infiltration, is subgrade compaction avoided??				
<b>Setback:</b> If facility is within 10 feet of property line/building, is adequate waterproofing membrane provided?				
<b>Underdrain and Aggregate Layer:</b> Does the underdrain have 3/8" holes spaced at least every 6"?				



1200 First Street NE, 5th Floor, Washington, DC 20002 | (202) 535-2600 | doee.dc.gov



**Figure L.6 Bioretention Construction Inspection Report.**

Inspection Items	Yes	No	Remarks	Date
Does the underdrain meet plan specifications for elevation and slope? Are cleanouts/observation wells and caps installed according to the plan specifications? Does the aggregate meet plan specifications? Does the aggregate depth match the plan?				
<b>Filter Media:</b> Does the filter media meet specifications? ( <i>Attach lab report and material certification.</i> ) Does the filter media depth match plan specifications?				
<b>Plant Materials:</b> Are all plants installed as per landscape plan? Is mulch/top soil installed as per plan specifications? Has the contributing drainage area been fully stabilized?				
<b>Observation Well:</b> Are cleanouts/observation wells free of construction debris and soil?				

Owner/ Agent \_\_\_\_\_ Inspector \_\_\_\_\_ Date \_\_\_\_\_

Figure L.5 (continued)

**GOVERNMENT OF THE DISTRICT OF COLUMBIA**  
Department of Energy and Environment



Construction and Maintenance Branch

**Sand Filter Construction Inspection Report**

Building Permit # \_\_\_\_\_ Plan and File # \_\_\_\_\_ Lot: \_\_\_\_\_ Square: \_\_\_\_\_  
 Project Address: \_\_\_\_\_  
 Sewer Type: CSS \_\_\_\_\_ MS4 \_\_\_\_\_ Other \_\_\_\_\_ Ward: \_\_\_\_\_  
 Contractor: \_\_\_\_\_ Email \_\_\_\_\_  
 Engineer: \_\_\_\_\_ Email \_\_\_\_\_  
 Responsible For Maintenance: \_\_\_\_\_ Email \_\_\_\_\_  
 Date Started: \_\_\_\_\_ Final Inspection Date: \_\_\_\_\_  
 Structure Type: Cast in placed \_\_\_\_\_ Prefabricated \_\_\_\_\_ Name of Plant: \_\_\_\_\_  
 As-Built Plan Due Date: \_\_\_\_\_

<b>Inspection Items:</b>	<b>Yes</b>	<b>No</b>	<b>Remarks</b>	<b>Date Completed</b>
<b>Subgrade:</b> Is sub grade suitable? ( free of debris, standing water) Is a subgrade Suitability Certification provided?				
<b>Prefabricated Structure:</b> Are shop drawings provided? Do type and location of openings meet specifications?				
<b>Cast-In-Place Structure:</b> Are structural drawings provided? Is a certification provided on steel placement? Is a load ticket provided showing concrete strength and mix? Is a certification provided for concrete placement?				
<b>Access:</b> Access for each chamber provided? (manholes, doors, steps, ladder)				



1200 First Street NE, 5th Floor, Washington, DC 20002 | (202) 535-2600 | doee.dc.gov



**Figure L.7 Sand Filter Construction Inspection Report.**

<p><b>Leak Test:</b> Does the leak test meet specifications? (Attach Form)</p>		
<p><b>Inflow Chamber:</b>  Does the orifice/ submerged weir opening meet specifications of the approved plan? (dimensions)  Is overflow/bypass installed per approved plan? (size, support, sealed)</p>		
<p><b>Filter Chamber :</b>  Is underdrain installed per approved plan? (specifications, number size and spacing of holes )  Is filter bed installed per approved plan? (specifications of sand, gravel and filter cloth)  <b>(Attach Materials Invoice)</b></p>		
<p><b>Outflow Chamber:</b>  Dewatering valve installed per approved plan?  Are perforated pipe openings installed?  Sump pit required?</p>		
<p><b>Back Fill:</b> Does backfill soil conform to specifications?  Is a certification for lift, thickness and density test provided?</p>		

Owner/ Agent \_\_\_\_\_ Inspector \_\_\_\_\_ Date \_\_\_\_\_

Figure L.6 (continued)

**GOVERNMENT OF THE DISTRICT OF COLUMBIA**  
 Department of Energy and Environment



Construction and Maintenance Branch  
**Infiltration Device Construction Inspection Report**

Building Permit # \_\_\_\_\_ Plan # \_\_\_\_\_ Lot: \_\_\_\_\_ Square: \_\_\_\_\_  
 Project Address: \_\_\_\_\_  
 \_\_\_\_\_ Ward: \_\_\_\_\_  
 Contractor: \_\_\_\_\_ Email \_\_\_\_\_  
 Engineer: \_\_\_\_\_ Email \_\_\_\_\_  
 Responsible For Maintenance: \_\_\_\_\_ Email \_\_\_\_\_  
 Date Started: \_\_\_\_\_ Final Inspection Date: \_\_\_\_\_  
 Structure Type: Infiltration Trench \_\_\_\_\_ Dry Well \_\_\_\_\_ Other \_\_\_\_\_  
 As-Built Plan Due Date: \_\_\_\_\_

Inspection Items	Yes	No	Remarks	Date Completed
<b>Infiltration device</b>				
Is the infiltration device located as per approved plan?				
Are dimensions per approved plan specifications? (width, depth, length or diameter and depth)				
Is the soil consistent with soil boring results and are infiltration test holes location s indicated?				
Does the filter fabrics meet the approved plan specifications and is installed per the approved plan specifications?				
Does all sand, stone or aggregate types meet the approved plan specifications?				
<b>Connections</b>				
Do under drain, overflow or retention structure meet the approved plan specifications? (Circle One) Connected to MS4 or CSS?				
Are cleanouts installed per approved plan?				
Are invoices provided for all materials?				
<b>Back Fill and Stabilization</b>				
Does the back fill comply with the approved plan specifications?				

Contractor/Engineer \_\_\_\_\_ Inspector \_\_\_\_\_ Date \_\_\_\_\_



1200 First Street NE, 5th Floor, Washington, DC 20002 | (202) 535-2600 | doee.dc.gov



**Figure L.8 Infiltration Device Construction Inspection Report.**

**GOVERNMENT OF THE DISTRICT OF COLUMBIA**  
 Department of Energy and Environment



Construction and Maintenance Branch

**Open Channel System Construction Inspection Report**

Building Permit #: \_\_\_\_\_ Plan and File#: \_\_\_\_\_ Lot: \_\_\_\_\_ Square: \_\_\_\_\_

Project Name and Address: \_\_\_\_\_ Ward \_\_\_\_\_

Contractor: \_\_\_\_\_ Telephone: \_\_\_\_\_

Engineer: \_\_\_\_\_ Telephone: \_\_\_\_\_

Responsible for Maintenance: \_\_\_\_\_ Telephone: \_\_\_\_\_

Open Channel System Type: Grass Channel \_\_\_\_\_ Dry Swale \_\_\_\_\_ Wet Swale \_\_\_\_\_ Other \_\_\_\_\_

Date Started: \_\_\_\_\_ Final Inspection Date: \_\_\_\_\_ As-Built Plan Due Date: \_\_\_\_\_

Inspection Items	Yes	No	Remarks	Date
<b>Site Preparation:</b>				
Have erosion and sediment controls been properly installed and maintained according to approved plans?				
Is stormwater runoff being diverted around the practice?				
Has the contributing drainage area been fully stabilized?				
<b>Practice Geometry:</b>				
Are the practice dimensions and longitudinal slope correct as shown on the plans?				
Are the channel side slopes no steeper than 3:1?				
Have the check dams been properly installed and to the correct elevations (where applicable)?				
<b>Pretreatment:</b>				
Are the pretreatment facilities installed according to the approved plans?				
<b>Vegetation:</b>				
Does the channel surface vegetation comply with the approved planting plan and specification?				
Topsoil mixture, soil amendments, and soil compaction comply with plan (if required)				
<b>Over Flow (where Applicable):</b>				
Is overflow invert at correct elevation?				



1200 First Street NE, 5th Floor, Washington, DC 20002 | (202) 535-2600 | doee.dc.gov



**Figure L.9 Open Channel System Construction Inspection Report.**

Inspection Items	Yes	No	Remarks	Date
Has the outfall been constructed with adequate protection as specified on the plans?				
<b>Dry Swale Designs (where Applicable):</b>				
Does planting soil meet design specifications?				
Does the underdrain meet specifications with correct hole pattern, elevation, and slope?				
Are at least 2 inches of aggregate provided above and below the underdrains?				
Does the reservoir storage layer drains within 72 hours?				

Owner/Agent \_\_\_\_\_ Inspector \_\_\_\_\_ Date \_\_\_\_\_

**Figure L.8 (continued)**



**GOVERNMENT OF THE DISTRICT OF COLUMBIA**  
Department of Energy and Environment



Construction and Maintenance Branch  
**Pond, Wetland, and Storage Practices - CONSTRUCTION INSPECTION REPORT**

Building Permit # \_\_\_\_\_ Plan and File # \_\_\_\_\_ Lot: \_\_\_\_\_ Square: \_\_\_\_\_  
 Project Address: \_\_\_\_\_ Ward: \_\_\_\_\_  
 Contractor: \_\_\_\_\_ Email \_\_\_\_\_  
 Engineer: \_\_\_\_\_ Email \_\_\_\_\_  
 Responsible For Maintenance: \_\_\_\_\_ Email \_\_\_\_\_  
 Type of Facility: Wet Pond \_\_\_\_\_ Wetland \_\_\_\_\_ Dry Pond \_\_\_\_\_ Underground Detention \_\_\_\_\_ Other \_\_\_\_\_  
 Date Started: \_\_\_\_\_ Final Inspection Date: \_\_\_\_\_ As-Built Plan Due Date: \_\_\_\_\_

Inspection Items	Yes	No	Remarks	Date Completed
<b>Contributing Drainage Area:</b> Does the area draining to the practice match the plans?				
<b>Practice Geometry:</b> Are the practice dimensions correct as shown on the plans? Are the pond side slopes no steeper than 3:1? Is a geotextile or clay lining provided (where appropriate)? Is the practice installed to the proper depth as shown on the plans?				
<b>Pretreatment:</b> Has the forebay been properly sized and designed as according to the plans?				
<b>Outfall:</b> Has the outfall been constructed with adequate protection as specified on the plans? Is the outfall channel lined with filter cloth and is large rip-rap provided? Is an emergency spillway provided?				
<b>Overflow and Trash Rack:</b> Has the riser or outflow structure been properly installed and to the correct elevations? Has a trash rack been properly installed according to the approved SWM plan?				
<b>Pond Buffer/Vegetation (where applicable):</b> Do the buffer dimensions match the plans? Is an aquatic bench properly installed? Does the vegetation comply with the approved planting plan and specification?				
<b>Final Inspection:</b> Has the contributing drainage area been properly stabilized? Does the site have proper maintenance and inspection access?				

Owner/Agent \_\_\_\_\_ Inspector \_\_\_\_\_ Date \_\_\_\_\_



1200 First Street NE, 5th Floor, Washington, DC 20002 | (202) 535-2600 | doee.dc.gov



**Figure L.10 Pond, Wetland, and Storage Practices Construction Inspection Report.**

**GOVERNMENT OF THE DISTRICT OF COLUMBIA**  
 Department of Energy and Environment



Construction and Maintenance Branch  
**Stormwater Management Facilities Inspection Report**

Building Permit # \_\_\_\_\_ Plan # \_\_\_\_\_ Lot: \_\_\_\_\_ Square: \_\_\_\_\_  
 Project Address: \_\_\_\_\_ Ward: \_\_\_\_\_  
 Contractor: \_\_\_\_\_ Email \_\_\_\_\_  
 Engineer: \_\_\_\_\_ Email \_\_\_\_\_  
 Responsible For Maintenance: \_\_\_\_\_ Email \_\_\_\_\_  
 Date Started: \_\_\_\_\_ Final Inspection Date: \_\_\_\_\_  
 Structure Type: \_\_\_\_\_ Serial # \_\_\_\_\_  
 Cast in Place: \_\_\_\_\_ Pre- Cast \_\_\_\_\_ Plant Location: \_\_\_\_\_ Certification \_\_\_\_\_  
 As-Built Plan Due Date: \_\_\_\_\_

Inspection Items	Yes	No	Remarks	Date Completed
<b>Site Preparation:</b> Is subgrade suitable?(free of debris, standing water) Is a subgrade suitability certification provided?				
<b>Inlets:</b> Do inlets meet plan specifications? (type, number and size)				
<b>Structure:</b> Do type and location of openings meet plan specifications? Are all components installed as per plan specifications? (media cartridges, weirs, inverted pipes, tees and ports)				
<b>Access:</b> Access for each chamber, including inlets where applicable provided? (manholes, doors, steps, ladders)				
<b>Backfill :</b> Does back fill meet specifications? Is a certification for lift, thickness and density test provided?				
<b>System Cleaned:</b>				

Owner /Agent \_\_\_\_\_ Inspector \_\_\_\_\_ Date \_\_\_\_\_



1200 First Street NE, 5th Floor, Washington, DC 20002 | (202) 535-2600 | doee.dc.gov



**Figure L.11 Stormwater Management Facilities Inspection Report.**

**GOVERNMENT OF THE DISTRICT OF COLUMBIA**  
 Department of Energy and Environment



Construction and Maintenance Branch

**Tree Planting and Preservation Construction Inspection Report**

Building Permit # \_\_\_\_\_ Plan and File # \_\_\_\_\_ Lot: \_\_\_\_\_ Square: \_\_\_\_\_  
 Project Address: \_\_\_\_\_ Ward: \_\_\_\_\_  
 Contractor: \_\_\_\_\_ Email \_\_\_\_\_  
 Engineer: \_\_\_\_\_ Email \_\_\_\_\_  
 Responsible For Maintenance: \_\_\_\_\_ Email \_\_\_\_\_  
 Date Started: \_\_\_\_\_ Final Inspection Date: \_\_\_\_\_ As-Built Plan Due Date: \_\_\_\_\_  
 Project Address: \_\_\_\_\_ File and WPD No.: \_\_\_\_\_

Inspection Items	Yes	No	Remarks	Date Completed
<b>Tree Preservation:</b> Is there an arborist report that includes an inventory of trees; trees to preserve; a description of tree & soil protection during and after construction; and the selection of tree species to be preserved? Does the arborist report match the stormwater management plan?				
<b>Planting Sites:</b> Is there at least 2 cubic feet of useable soil per square foot of average mature tree canopy?				
<b>Planting Techniques:</b> Is the root collar exposed? Are erosion control blankets or other appropriate practices in place on steep slopes? With slopes steeper than 3:1, are trees planted on a level space on the slope?				



1200 First Street NE, 5th Floor, Washington, DC 20002 | (202) 535-2600 | doee.dc.gov



**Figure L.12 Tree Planting and Preservation Construction Inspection Report.**

Appendix L Construction Inspection Checklists

---

<p><b>Post-Planting Tree Protection:</b></p> <p>Has 2-4 inches of organic mulch been spread over the soil surface out to the drip line of the tree?</p> <p>Are trees staked only if there is a concern of vandalism or windy exposure?</p> <p>In areas with known deer presence and especially in or adjacent to parks, natural areas, and open spaces, has deer protection been installed in the form of trunk guards or welded-wire fencing?</p>				
--	--	--	--	--

Owner/ Agent \_\_\_\_\_ Inspector \_\_\_\_\_ Date \_\_\_\_\_

**Figure L.13 (continued)**



**GOVERNMENT OF THE DISTRICT OF COLUMBIA  
DEPARTMENT OF ENERGY & ENVIRONMENT  
Natural Resources Administration  
Inspection & Enforcement Division**

**STORMWATER MANAGEMENT STANDARD TESTING RECORD**

PLAN # \_\_\_\_\_ WPD/ FILE # \_\_\_\_\_ BUILDING PERMIT # \_\_\_\_\_

SQUARE \_\_\_\_\_ LOT \_\_\_\_\_ PARCEL \_\_\_\_\_

NAME AND LOCATION: \_\_\_\_\_  
\_\_\_\_\_

TYPE OF STRUCTURE: \_\_\_\_\_

BUILT:  Cast in place  Pre-Cast  Other \_\_\_\_\_

METHOD OF TESTING:  H<sub>2</sub>O  Visual  Other \_\_\_\_\_

READINGS: Start \_\_\_\_\_  
Difference \_\_\_\_\_  
Allowable \_\_\_\_\_  
Results \_\_\_\_\_

DURATION: (24 Hour Reading) \_\_\_\_\_ Time: \_\_\_\_\_ Date: \_\_\_\_\_  
(48 Hour Reading) \_\_\_\_\_ Time: \_\_\_\_\_ Date: \_\_\_\_\_  
(72 Hour Reading) \_\_\_\_\_ Time: \_\_\_\_\_ Date: \_\_\_\_\_

READINGS TAKEN BY: \_\_\_\_\_ DATE: \_\_\_\_\_

WITNESS: \_\_\_\_\_ DATE: \_\_\_\_\_

TITLE: \_\_\_\_\_


FOR: \_\_\_\_\_

Inspector \_\_\_\_\_ Owner/Agent \_\_\_\_\_

Date \_\_\_\_\_

SWM STANDARD TESTING/ IED 2019

**Figure L.14 Stormwater Management Standard Testing Record.**



**GOVERNMENT OF THE DISTRICT OF COLUMBIA  
DEPARTMENT OF ENERGY & ENVIRONMENT  
WATERSHED PROTECTION DIVISION/INSPECTION & ENFORCEMENT BRANCH**

## Green Area Ratio - Landscape Checklist

---

I, \_\_\_\_\_, declare as follows:  
**Full Name of Certified Landscape Expert (Printed)**

I am a Certified Landscape Expert, as defined in DCMR Title 11, Subtitle C, Chapter 6, responsible for confirming installation of the approved landscape plan for development located at:

\_\_\_\_\_, Washington, DC, and developed pursuant to:  
**Street Address (Printed)**

\_\_\_\_\_ **Building Permit Number**      \_\_\_\_\_ **DOEE Plan Number**  
 \_\_\_\_\_ **Lot**      \_\_\_\_\_ **Square**

The landscape elements shown on the DOEE-approved landscape plan or DOEE-approved modification for this property have been installed as approved and in a manner consistent with the standards of 11 DCMR Chapter 34. This includes the number size, and approximate location of plantings and other approved landscape elements.

Any changes or species substitutions (if applicable) have been approved by DOEE.

A completed Landscape Maintenance Plan has been submitted to the property owner.

I declare under penalty of perjury under the laws of the District of Columbia that the following is true and correct.

\_\_\_\_\_  
**Signature of Certified Landscape Expert      Certification/Registration Number      Date**

**NOTE:** If any landscape elements have been changed during installation, DO NOT SIGN OR SUBMIT this checklist until a revised landscape plan has been approved by the Department of Energy & Environment. If you provide false information in this document, you may be subject to criminal or civil liability.

---

**[TO BE COMPLETED BY DOEE INSPECTOR]**

The DOEE inspector signature indicates the present condition of credited GAR landscape elements to be in compliance with the GAR approved plan. The DOEE inspection reflects the condition of components that are accessible, observable, or otherwise documented by the inspector.

Document received by: \_\_\_\_\_  
**Inspector Signature      Printed Name      Badge No.      Date**

**Figure L.15 Green Area Ratio Landscape Checklist**

# Appendix M Maintenance Inspection Checklists

It is recommended that an annual maintenance inspection and cleanup be conducted at each best management practice (BMP) site, particularly at large-scale applications.

This appendix includes the following maintenance inspection checklists (see Figures M.1 through M.13):

- Green Roof Maintenance Inspection
- Rainwater Harvesting Maintenance Inspection
- Impervious Surface Disconnection Maintenance Inspection
- Permeable Pavement Maintenance Inspection
- Bioretention Maintenance Inspection
- Sandfilter Inspection Report
- Infiltration Facilities Maintenance Inspection
- Open Channel Systems Maintenance Inspection
- Pond and Wetland Maintenance Inspection
- Storage and Underground Detention Maintenance Inspection
- Stormwater Management Facilities Maintenance Inspection
- Tree Planting and Preservation Maintenance Inspection
- Maintenance Service Completion Inspection

The checklists are subject to change with the latest versions available at <https://doee.dc.gov/swguidebook>.

GOVERNMENT OF THE DISTRICT OF COLUMBIA  
Department of Energy and Environment



Green Roof Maintenance Inspection Report		
Name/Facility Address:		File/Plan no.
Owner/Agent:		Ward:
Mailing Address:		
Phone/Email		
Date/Weather		
Maintenance Item	Yes/No/N/A	Comments
1. Roof Condition		
Overflow Drains		
Repair needed		
Clear of debris/weeds		
Peeling or physical damage		
Standing water or leaks		
Damage to flashing/roof penetrations		
Accessible (railings & ladders)		
2. Vegetation		
Roof type:		Intensive/Extensive/ Semi-intensive
Dead or disease plants		
Weeds, moss, invasive plants		
Erosion or loss of media		
At least 80% coverage		
Replanting needed		
Date of last service		
3. Irrigation and Leak Detection		
Watering method		Hose or Sprinkler
Mechanical systems		Timers/Sensors/ Zones
Leak detection provided		



1200 First Street NE, 5th Floor, Washington, DC 20002 | (202) 535-2600 | doee.dc.gov



Figure M.1 Green Roof Maintenance Inspection Report.



Actions to be Taken:

Page 2 of 2

**Figure M.1 (continued)**

**GOVERNMENT OF THE DISTRICT OF COLUMBIA**  
Department of Energy and Environment



<b>Rainwater Harvesting Maintenance Inspection Report</b>		
Name/Facility Address:		File/Plan no.
Owner/Agent:		Ward:
Mailing Address:		
Phone/Email		
Date/Weather		
Maintenance Item	Yes/No/N/A	Comments
<b>1. Cisterns and Water Quality Treatment</b>		
Cistern in good repair		
Pump functioning properly		
Disinfection system in place and type		
Filtration system		
Recirculation system installed		
Recirculation schedule (how often is the water recirculated)		
<b>2. Collection, Conveyance, Pre-treatment, Storage</b>		
Debris in gutter/downspouts		
Debris in prescreening devices		
Debris in first flush diverters		
Debris in hydrodynamic separator		
Mosquito screens inadequate		
Sediment accumulation in tank		
Inadequate tank drawdown		
<b>3. Distribution and Overflow</b>		
Discharging to BMP		



1200 First Street NE, 5th Floor, Washington, DC 20002 | (202) 535-2600 | doee.dc.gov




**Figure M.2 Rainwater Harvesting Maintenance Inspection Report.**

Re-use to (e.g. flushing toilets, irrigation, cooling towers)		
Overflow device		
Outlet erosion		
Debris/sediment in overflow		
Overflow repair needed		
<b>Actions to be Taken:</b>		

Figure M.2 (continued)

**GOVERNMENT OF THE DISTRICT OF COLUMBIA**  
Department of Energy and Environment



**Impervious Surface Disconnection Maintenance Inspection Report**

Project Address: \_\_\_\_\_ Plan Number / File Number: \_\_\_\_\_

Mailing Address: \_\_\_\_\_ Ward: \_\_\_\_\_

Owner/Agent: \_\_\_\_\_ Phone: \_\_\_\_\_ Lot: \_\_\_\_\_ Square: \_\_\_\_\_

**Y/N**

As-built plan available

Service contract

Review of on-site maintenance logs

Simple disconnection

Disconnection to dry well

Disconnection to rain garden

Other type of disconnection:

Last inspection date:

Last service date:

Type of service contract (if any):

Time since last rain > 1" +/-  Days /  Hours

**I. Contributing Drainage Area**

**Y/N**

Rooftop contributing drainage area

Parking lot contributing drainage area

Other contributing drainage area:

**II. Receiving Area**

**Y/N**

Improper conveyance to receiving pervious area

Receiving area encroachment

Compaction in receiving area

Erosion at inflow points

Erosion in flow path

Dead vegetation

Exposed soil

Sediment accumulation

Evidence of standing water

1 of 2

**Figure M.3 Impervious Cover Surface Disconnection Maintenance Inspection Report.**

**Impervious Surface Disconnection Maintenance Inspection Report  
(continued)**

III. Observations

IV. Signatures

Owner/Agent: \_\_\_\_\_ Inspector: \_\_\_\_\_ Date: \_\_\_\_\_

**Figure M.3 (continued)**

GOVERNMENT OF THE DISTRICT OF COLUMBIA  
 Department of Energy and Environment



Permeable Pavement Maintenance Inspection Report		
Name/Facility Address:		File/Plan no.
Owner/Agent:		Ward:
Mailing Address:		
Phone/Email		
Date/Weather		
Maintenance Item	Yes/No/N/A	Comments
1. Surface Condition		
Clear of debris/sediment/weeds		
Evidence of surface clogging		
Sweeping needed		
Surface deformation or spalling		
Structure repair needed		
2. Underdrains and Cleanouts		
Underdrain(s)		
Observation well(s)		
Evidence of surface clogging		
Standing water		
Last rain event >1"		____ Hours / ____ Days
3. Overflow		
Overflow device		
Debris and sediment in overflow		
Overflow repair needed		
Actions to be Taken:		



1200 First Street NE, 5th Floor, Washington, DC 20002 | (202) 535-2600 | doee.dc.gov



Figure M.4 Permeable Pavement Maintenance Inspection Report.

GOVERNMENT OF THE DISTRICT OF COLUMBIA  
Department of Energy and Environment



<b>Bioretention/Planters Maintenance Inspection Report</b>		
Name/Facility Address:		File/Plan no.
Owner/Agent:		Ward:
Mailing Address:		
Phone/Email		
Date/Weather		
<b>Maintenance Item</b>	<b>Yes/No/N/A</b>	<b>Comments</b>
<b>1. Inlets and Drainage Area</b>		
Inlet type(s)		
Inlet repair needed		
Pre-treatment clear of debris/sediment		
Evidence of erosion in drainage area		
Drainage area clear of trash/debris/clippings		
Stone weir sediment accumulation		
<b>2. Bioretention Facility</b>		
Sediments and trash accumulation		
Filter surface clogging		
Overflow clear of debris		
Erosion in facility		
Inadequate mulch thickness		
Outlets in good condition		
Outlets repair needed		
Underdrains/Observation wells/Clean-outs		
Dewaters between storms within 48 hours		
<b>3. Vegetation</b>		
Dead or diseased plants		
Stakes and wires		
Inadequate watering		



1200 First Street NE, 5th Floor, Washington, DC 20002 | (202) 535-2600 | doee.dc.gov



Figure M.5 Bioretention Maintenance Inspection Report.

Actions to be Taken:

Page 2 of 2

**Figure M.5 (continued)**



GOVERNMENT OF THE DISTRICT OF COLUMBIA  
 Department of Energy and Environment



<b>Sandfilter Maintenance Inspection Report</b>		
Name/Facility Address:		File/Plan no.
Owner/Agent:		Ward:
Mailing Address:		
Phone/Email		
Date/Weather		
<b>Maintenance Item</b>	<b>Yes/No/N/A</b>	<b>Comments</b>
<b>1. Structural Components</b>		
Observation wells		
Maintenance doors		
Manholes		
Inlet/Outlets		
Valves/Drains		
Other		
<b>2. Inlets</b>		
Inlet Type(s)		
Inlet repair needed		
Inlet clear of debris/sediment		
<b>3. Chambers</b>		
Sediment/debris first chamber		
Sediment/debris on filter bed (2nd chamber)		
Sediment/debris in clear well (3rd chamber)		
Water seal		
Oil/Grease accumulation		
Debris accumulation		
Filter bed condition		
Standing water in 2 <sup>nd</sup> chamber		
Evidence of bypass		



1200 First Street NE, 5th Floor, Washington, DC 20002 | (202) 535-2600 | doee.dc.gov



Figure M.6 Sandfilter Maintenance Inspection Report.

Actions to be Taken:

Page 2 of 2

**Figure M.6 (continued)**

GOVERNMENT OF THE DISTRICT OF COLUMBIA  
Department of Energy and Environment



Infiltration Facilities Maintenance Inspection Report		
Name/Facility Address:		File/Plan no.
Owner/Agent:		Ward:
Mailing Address:		
Phone/Email		
Date/Weather		
Maintenance Item	Yes/No/N/A	Comments
<b>1. Inlets and Drainage Area</b>		
Inlet Type(s)		
Inlet repair needed		
Inlet clear of debris/sediment		
Evidence of erosion in drainage area		
Drainage area clear of trash/debris		
Evidence of pretreatment bypass		
<b>2. Structural Components and Function</b>		
Vegetation and ground cover type		Grass/Sod/Media
Surface erosion present		
Infiltration area in good repair		
Observation wells in good repair		
Debris and sediment present		
Standing water		
Last rain event >1"		____ Hours / ____ Days
<b>3. Overflow</b>		
Overflow device		
Debris/sediment in overflow		
Overflow repair needed		



1200 First Street NE, 5th Floor, Washington, DC 20002 | (202) 535-2600 | doee.dc.gov



Figure M.7 Infiltration Facilities Maintenance Inspection Report.

Actions to be Taken:

Page 2 of 2

**Figure M.7 (continued)**

GOVERNMENT OF THE DISTRICT OF COLUMBIA  
 Department of Energy and Environment



<b>Open Channel Maintenance Inspection Report</b>		
Name/Facility Address:		File/Plan no.
Owner/Agent:		Ward:
Mailing Address:		
Phone/Email		
Date/Weather		
<b>Maintenance Item</b>	<b>Yes/No/N/A</b>	<b>Comments</b>
<b>1. Inlets and Drainage Area</b>		
Inlet Type(s)		
Inlet repair needed		
Inlet clear of debris/sediment		
Erosion at inlets		
Evidence of erosion in drainage area		
Evidence of pretreatment bypass		
<b>2. Open Channel Facility</b>		
Clear of debris/sediment		
Erosion within facility		
Ponding of water		
Check dams in good repair		
Outlet in good repair		
<b>3. Vegetation</b>		
Dead vegetation		
Bare spots		
Invasive species		
Re-vegetation needed		
<b>Actions to be Taken:</b>		



1200 First Street NE, 5th Floor, Washington, DC 20002 | (202) 535-2600 | doee.dc.gov



Figure M.8 Open Channel Systems Maintenance Inspection Report.

**GOVERNMENT OF THE DISTRICT OF COLUMBIA**  
Department of Energy and Environment



<b>Ponds and Wetlands Maintenance Inspection Report</b>		
Name/Facility Address:		File/Plan no.
Owner/Agent:		Ward:
Mailing Address:		
Phone/Email		
Date/Weather		
Maintenance Item	Yes/No/N/A	Comments
<b>1. Inlets and Drainage Area</b>		
Inlet Type(s)		
Inlet repair needed		
Inlet clear of debris/sediment		
Erosion in drainage area		
Drainage area debris accumulation		
Pretreatment bypass		
<b>2. Facility Function and Structural Components</b>		
Erosion within facility		
Clear of debris/sediment		
Inadequate water level		
Excessive algal growth		
Overflow device		
Debris/sediment in overflow		
Overflow repair needed		
<b>3. Vegetation</b>		
Dead or diseased plants		
Inadequate vegetation		
Lack of aquatic bench		



1200 First Street NE, 5th Floor, Washington, DC 20002 | (202) 535-2600 | doee.dc.gov



**Figure M.9 Pond and Wetland Maintenance Inspection Report.**

Lack of plant diversity		
<b>Actions to be Taken:</b>		

Figure M.9 (continued)

**GOVERNMENT OF THE DISTRICT OF COLUMBIA**  
Department of Energy and Environment



<b>Storage and Underground Detention Maintenance Inspection Report</b>		
Name/Facility Address:		File/Plan no.
Owner/Agent:		Ward:
Mailing Address:		
Phone/Email		
Date/Weather		
Type of practice:		
Maintenance Item	Yes/No/N/A	Comments
<b>1. Inlets and Drainage Area</b>		
Inlet type(s)		
Inlet repair needed		
Inlet clear of debris/sediment		
Erosion in drainage area		
Drainage area debris accumulation		
Evidence of pretreatment bypass		
<b>2. Practice Function</b>		
Inadequate vegetation/ground cover		
Surface erosion in practice		
Clear of debris/sediment		
Inadequate drawdown/standing water		
<b>3. Structural Components</b>		
Overflow device		
Debris/sediment in overflow		
Overflow device repair needed		
Vaults and chamber		
Debris/sediment in chambers		



1200 First Street NE, 5th Floor, Washington, DC 20002 | (202) 535-2600 | doee.dc.gov




**Figure M.10 Storage and Underground Detention Maintenance Inspection Report.**



Vaults/chamber repair needed		
<b>Actions to be Taken:</b>		

Figure M.10 (continued)

**GOVERNMENT OF THE DISTRICT OF COLUMBIA**  
Department of Energy and Environment



**Stormwater Management Facilities Maintenance Inspection Report**

Project Address: \_\_\_\_\_ Plan Number / File Number: \_\_\_\_\_

Mailing Address: \_\_\_\_\_ Ward: \_\_\_\_\_

Owner/Agent: \_\_\_\_\_ Phone: \_\_\_\_\_ Lot: \_\_\_\_\_ Square: \_\_\_\_\_

**Y/N**

As-built plan available

Service contract

Review of on-site maintenance logs

Hydrodynamic treatment

Filtering treatment

Retention

Last inspection date:

Last service date:

Type of service contract (if any):

Time since last rain > 1" +/-  Days /  Hours

**I. Inlets and Drainage Area Stabilization**

**Y/N**

Inlets need repair

Clear of debris

Graded areas

Inlet type(s):

Total number:

**II. Structure**

**Y/N**

Access

Outlets

Elbows and connections

Vaults and chambers

Track racks

**III. Overall Function**

**Y/N**

Oil and grease accumulation

Sediment

Debris accumulation

1 of 2

**Figure M.11 Stormwater Management Facilities Maintenance Inspection Report.**

**Stormwater Management Facilities Maintenance Inspection Report  
(continued)**

**IV. Observations**

**V. Signatures**

Owner/Agent: \_\_\_\_\_ Inspector: \_\_\_\_\_ Date: \_\_\_\_\_

**Figure M.11 (continued)**

GOVERNMENT OF THE DISTRICT OF COLUMBIA  
Department of Energy and Environment



Tree Planting and Preservation Maintenance Inspection Report		
Name/Facility Address:		File/Plan no.
Owner/Agent:		Ward:
Mailing Address:		
Phone/Email		
Date/Weather		
Maintenance Item	Yes/No/N/A	Comments
<b>1. Tree Condition</b>		
Adequately watered		
Dead/broken/diseased branches pruned		
Trunk protected		
Root collar exposed		
Tree damaged		
Insect or disease problems		
<b>2. Mulching</b>		
2-4 inch deep mulch		
Mulch not against trunk		
<b>3. Staking (if needed)</b>		
Tree age < 1 year: stakes in place		
Tree age > 1 year: stakes removed		
Webbing or ties hampering growth of tree		
<b>Actions to be Taken:</b>		



1200 First Street NE, 5th Floor, Washington, DC 20002 | (202) 535-2600 | doee.dc.gov



Figure M.12 Tree Planting and Preservation Maintenance Inspection Report.

**GOVERNMENT OF THE DISTRICT OF COLUMBIA**  
Department of Energy and Environment



**Maintenance Service Completion Inspection Report**

Name/Address: \_\_\_\_\_

Owner/Agent: \_\_\_\_\_ WPD No: \_\_\_\_\_

Mailing Address: \_\_\_\_\_

Service Providers: \_\_\_\_\_

Maintenance Service Start Date: \_\_\_\_\_

Maintenance Service Completion Date: \_\_\_\_\_

Type of Stormwater Practice Serviced: \_\_\_\_\_

Description of Work: \_\_\_\_\_

\_\_\_\_\_

\_\_\_\_\_

Is the maintenance service satisfactory? Yes/No If no, list items to be completed: \_\_\_\_\_

\_\_\_\_\_

\_\_\_\_\_

\_\_\_\_\_

Inspector \_\_\_\_\_ Received By \_\_\_\_\_ Date \_\_\_\_\_

**Figure M.13 Maintenance Service Completion Inspection Report.**



# Appendix N Rainwater Harvesting Treatment and Management Requirements

## N.1 Introduction

The majority of the information and requirements provided herein are excerpted from the 2017 Water Environment and Reuse Foundation Report: Risk-Based Framework for the Development of Public Health Guidance for Decentralized Non-Potable Water Systems (DNWS Report). In some cases, text from this report has been modified to conform to this guidebook and DOEE's review and inspection procedures.

The purpose of this appendix is to provide information and guidance through a risk-based framework to help designers and DOEE ensure that all rainwater harvesting systems are adequately protective of public health. This appendix identifies pathogen reduction targets that must be met and various treatment systems that can be used to meet the targets. Other considerations, including volatile organic compound (VOC) limits, storage and distribution management, operation and maintenance, and long-term monitoring and reporting requirements, are also discussed.

## N.2 Pathogen Reduction Targets

Risk-based pathogen reduction targets have been developed based on analysis of potential human health risks associated with exposure to microbial hazards and are based on a "10<sup>-4</sup> Per Person Per Year Benchmark." This means that the agreed-upon "tolerable" risk level is a probability of infection of 1 in 10,000 people per year. Pathogen reduction targets are expressed in terms of the 95th percentile log<sub>10</sub> reduction target (LRT). A log reduction is a mathematical term used to describe the number of living microbes relatively eliminated by disinfection or filtration. A log<sub>10</sub> reduction reduces the quantity of living microbes to one-tenth its previous amount. Therefore, a 1-log<sub>10</sub> reduction equates to 90% removal, 2-log<sub>10</sub> reduction to 99% removal, 3-log<sub>10</sub> reduction to 99.9% removal, and so on. The LRT for the specified pathogen group (i.e. viruses, bacteria, or protozoa) describes the agreed level of risk to individuals. LRTs were developed for each source water and end use addressed in this appendix based on attaining the "tolerable" infection risk. If a system can maintain this level of treatment performance at all times, then the predicted probability of infection across the population will be less than the 1 in 10,000 benchmark for each pathogen 95% of the time.

The LRT for each non-potable use scenario is presented in Table M.1 for healthy adults (values are based on the DNWS Report, although additional uses have been added). A rainwater harvesting system must maintain this level of treatment performance at all times for all three pathogen types: viruses, protozoa, and bacteria. When both general runoff and roof runoff (as defined below Table N.1) are combined, the reduction targets for general runoff shall apply. Similarly, when multiple uses are proposed, the highest reduction targets shall apply.

**Table N.1 Ninety-Fifth Percentile Log<sub>10</sub> Pathogen Reduction Targets (LRT) to Meet 10<sup>-4</sup> (infection) ppy Benchmarks for Healthy Adults<sup>a</sup>**

Water Source and Use	Log <sub>10</sub> Reduction Targets for 10 <sup>-4</sup> Per Person Per Year Benchmarks		
	Enteric Viruses	Parasitic Protozoa	Enteric Bacteria
General Runoff <sup>a</sup>			
Cooling Towers <sup>b</sup>	–	–	–
Irrigation	3.0	2.5	2.0
Indoor Use	3.5	3.5	3.0
Roof Runoff <sup>c</sup>			
Cooling Towers <sup>b</sup>	–	–	–
Irrigation	N/A	Limited data available	3.5
Indoor Use	N/A	Limited data available	3.5

- a. For the purposes of this appendix, general runoff means precipitation runoff from rain or snowmelt events that flows over land and/or impervious surfaces (e.g., streets, sidewalks, and parking lots). It also includes runoff from roofs or parking garages with frequent public access.
- b. The pathogen risks associated with cooling towers and other uses in which there is no public exposure can be controlled by post-treatment management practices rather than initial treatment. There are greater microbial risks from this use due to uncontrolled growth of water-based pathogens (e.g., Legionella pneumophila, Pseudomonas aeruginosa, and non-tuberculous mycobacteria) that may proliferate during prolonged periods of storage. Management practices are discussed in Section M.5, “Storage and Distribution Management Practices.”
- c. Roof runoff means precipitation from a rain or snowmelt event that is collected directly from a roof surface not subject to frequent public access.

The non-potable uses and LRTs included in Table N.1 assume that human contact with the harvested water will be infrequent and ingestion unintentional. The remaining sections in this appendix only cover non-potable uses with infrequent human contact. Treatment and monitoring procedures for frequent contact uses will be reviewed on a case-by-case basis.

### N.3 Treatment Process

A well-established and accepted concept in modern drinking water and water reuse practices is to attribute the log<sub>10</sub> reduction of pathogen groups to specific technologies that are operated within defined limits, coupled with appropriate control points to demonstrate the proper performance of the technology. This is referred to as the log<sub>10</sub> reduction value (LRV) and can be compared directly to the LRTs described in Section N.2 above. Various treatment processes and treatment trains can be used to obtain the LRT for each pathogen for a given combination of source water and end use. Sections N.3.1 and N.3.2 discuss a range of treatment processes and provide LRVs for each process.

#### N.3.1 Filtration

The removal of particulate matter, including pathogens, by size exclusion can serve as a barrier to pathogens in water. Filtration is especially important because pathogens can be shielded by or



embedded in particulate matter, reducing the effectiveness of subsequent disinfection processes. Typical values for pathogen group log<sub>10</sub> reduction by filtration processes are summarized in Table N.2.

**Table N.2 Typical Values for Pathogen Reduction Using Filtration Processes**

Barrier	Typical Log <sub>10</sub> Reduction Values		
	Virus	Protozoa	Bacteria
Slow sand filter	2	4	2
Dual media filter with coagulant	1	2	1
Cartridge/bag filter (5-10 microns)	0	0	0
Cartridge/bag filter (3 microns or less)	0	3	0
Cartridge/bag filter (1 micron)	0	4	0
Diatomaceous earth	1	4	2
Microfilter	1	6	6
Ultrafilter or Nanofilter	6	6	6
Reverse osmosis	6	6	6

### N.3.2 Disinfection

Processes for pathogen inactivation include disinfection by chlorine, peracetic acid, ozone, ultraviolet (UV) radiation, advanced oxidation, and pasteurization. Particles in water can inhibit effective disinfection through shading (in the case of UV) and shielding embedded pathogens. Larger particles may require more time for a disinfecting agent to penetrate the particle and reach an embedded pathogen; therefore, for any disinfectant to be effective, particles larger than 10 microns must be removed.

Typical values for the inactivation of pathogens for disinfection processes in filtered water are given in Tables N.3 through N.5. These values serve as a guide to the relative effectiveness of different disinfection technologies and are not for a specific microorganism.

**Table N.3 Typical Values for Various Levels of the Inactivation of Enteric Virus in Filtered Secondary Effluent with Selected Disinfection Processes**

Disinfectant	Unit <sup>b</sup>	Dose for Corresponding Log <sub>10</sub> Reduction Value			
		1 Log <sub>10</sub>	2 Log <sub>10</sub>	3 Log <sub>10</sub>	4 Log <sub>10</sub>
Free chlorine	mg•min/L	–	1.5–1.8	2.2–2.6	3.0–3.5

Chloramine <sup>a</sup>	mg•min/L	–	370–400	550–600	750–800
Peracetic acid	mg•min/L	NA	NA	NA	NA
Ozone	mg•min/L	–	0.25–0.30	0.35–0.45	0.50–0.60
Ultraviolet radiation	mJ/cm <sup>2</sup>	50–60	90–110	140–150	180–200
Advanced oxidation	mJ/cm <sup>2</sup>	10–20	50–60	70–80	110–130
Pasteurization (60°C)	second	140	280	420	560

a. Due to interferences with chloro-organic compounds, when chloramine is used as a disinfectant, log<sub>10</sub> reductions can only be used if the actual dosage of monochloramine is known, not just the amount of combined chlorine.

b. mg•min/L = Milligram-minutes per liter

c. mJ/cm<sup>2</sup> = Millijoules per square centimeter

**Table N.4 Typical Values for Various Levels of the Inactivation of Parasitic Protozoa in Filtered Secondary Effluent with Selected Disinfection Processes**

Disinfectant	Unit <sup>b</sup>	Dose for Corresponding Log <sub>10</sub> Reduction Value			
		1 Log <sub>10</sub>	2 Log <sub>10</sub>	3 Log <sub>10</sub>	4 Log <sub>10</sub>
Free chlorine	mg•min/L	2,000–2,600	NA	NA	NA
Chloramine <sup>a</sup>	mg•min/L	NA	NA	NA	NA
Peracetic acid	mg•min/L	NA	NA	NA	NA
Ozone	mg•min/L	4.0–4.5	8.0–8.5	12–13	NA
Ultraviolet radiation	mJ/cm <sup>2</sup>	2–3	5–6	11–12	20–25
Advanced oxidation	mJ/cm <sup>2</sup>	2–3	5–6	10–12	20–25
Pasteurization (60°C)	second	30	60	90	120

a. Due to interferences with chloro-organic compounds, when chloramine is used as a disinfectant, log<sub>10</sub> reductions can only be used if the actual dosage of monochloramine is known, not just the amount of combined chlorine.

b. mg•min/L = Milligram-minutes per liter.

c. mJ/cm<sup>2</sup> = Millijoules per square centimeter

**Table N.5 Typical Values for Various Levels of the Inactivation of Enteric Bacteria in Filtered Secondary Effluent with Selected Disinfection Processes**

Disinfectant	Unit <sup>b</sup>	Dose for Corresponding Log <sub>10</sub> Reduction Value			
		1 Log <sub>10</sub>	2 Log <sub>10</sub>	3 Log <sub>10</sub>	4 Log <sub>10</sub>
Free chlorine	mg•min/L	0.4–0.6	0.8–1.2	1.2–1.8	1.6–2.4
Chloramine <sup>a</sup>	mg•min/L	50–70	95–150	140–220	200–300

Peracetic acid	mg•min/L	10–25	40–60	75–125	150–200
Ozone	mg•min/L	0.005–0.01	0.01–0.02	0.02–0.03	0.03–0.04
Ultraviolet radiation	mJ/cm <sup>2</sup>	10–15	20–30	30–45	40–60
Advanced oxidation	mJ/cm <sup>2</sup>	4–6	6–8	8–10	10–12
Pasteurization (60°C)	second	50	100	150	200

- a. Due to interferences with chloro-organic compounds, when chloramine is used as a disinfectant, log<sub>10</sub> reductions can only be used if the actual dosage of monochloramine is known, not just the amount of combined chlorine.
- b. mg•min/L = Milligram-minutes per liter
- c. mJ/cm<sup>2</sup> = Millijoules per square centimeter

### N.3.3 Treatment Trains

Most non-potable water systems use a number of unit processes in series to accomplish treatment, known commonly as the “multiple barrier” approach. Multiple barriers are used to improve the reliability of a treatment approach through process redundancy, robustness, and resiliency. When multiple treatment barriers are used to achieve the pathogen LRT, the contribution from each barrier is cumulative.

In addition to these treatment barriers, operational and management barriers are used to ensure that systems are in place to respond to non-routine operation. Treatment barriers can be monitored using sensors and instrumentation for continuous process monitoring. The system should take the treatment train offline automatically in the event of process malfunction.

If each barrier in a treatment train is independent, the LRVs for each process in the treatment train can be added together to obtain the overall treatment train LRV.

## N.4 Volatile Organic Compounds

For rainwater harvesting systems that use general runoff from vehicular access areas as a source and will have some level of public exposure risk, the treated water must be tested for the presence of volatile organic compounds (VOCs); however, this does not apply when the water will be used for cooling towers or other “no public exposure” uses. The test must be performed by the system operator prior to commissioning of the system (see Section N.6, “Commissioning”) and prior to subsequent DOEE maintenance inspections (see Section N.7, “Operational Monitoring and Reporting”). VOC levels must be below the maximums indicated in Table N.6. If any VOC levels exceed these limits, the rainwater harvesting system must not be utilized until the problem is satisfactorily addressed, and a successful test has been performed. VOC limit exceedances may be addressed through source controls or through provision of additional treatment devices.

**Table N.6 Volatile Organic Compound Maximum Concentrations**

VOC	Maximum Concentration (mg/L) <sup>a</sup>
Benzene	0.1
Carbon Tetrachloride	0.5

1,2-Dichlorobenzene	5.4
1,4-Dichlorobenzene	5.4
1,1 Dichloroethane	14.4
1,2 Dichloroethane	0.1
1,1-Dichloroethylene	0.1
cis-1,2-Dichloroethylene	28.4
trans-1,2-Dichloroethylene	28.4
Dichloromethane	3.1
1,2-Dichloropropane	12.6
1,3-Dichloropropene	0.2
Ethylbenzene	15.6
Methyl-tert-butyl ether	5.2
Monochlorobenzene	1.7
Styrene	7.7
1,1,2,2-Tetrachloroethane	0.3
Tetrachloroethylene	6.1
Toluene	6.8
1,2,4-Trichlorobenzene	1.4
1,1,1-Trichloroethane	68.2
1,1,2-Trichloroethane	1.6
Trichloroethylene	4.8
Trichlorofluoromethane	201.1
1,1,2-Trichloro-1,2,2-Trifluoroethane	272.9
Vinyl Chloride	0.1
Xylenes	15.6

a. Values determined by the San Francisco Department of Public Health based on U.S. Occupational Safety and Health Administration Permissible Exposure Limits for 8-hour inhalation exposures to selected VOCs.

## N.5 Storage and Distribution Management Practices

To achieve the desired objectives of public health protection, treated water must be properly stored and distributed to prevent compromising the quality of water after treatment. For example, opportunistic pathogens like Legionella could grow in the distribution system, sewage could contaminate treated water, or lead and copper (which are toxic) could leach from piping. Producing adequate quality non-potable water that meets all the pathogen control criteria set forth in this appendix is the first step in ensuring proper public health protection. The final step

in quality control is to manage properly 1) storage and distribution systems and 2) the uses of non-potable water.

In rainwater harvesting systems, neither significant or routine ingestion nor direct contact with the treated water product is typically anticipated due to limited exposures to non-potable water. Nevertheless, the occurrence of aerosol inhalation and indirect contact requires the careful management of DNWS storage and distribution systems to control exposures to non-tuberculous mycobacterial and Legionella pathogens. For example, even clean drinking water may allow biofilm growth of Legionella (aerosol pathogen risk) if the water temperature is between 25°C and 45°C and stagnates, resulting in the presence of minimal residual chlorine.

A number of approaches are available to control microbial regrowth in distribution systems, each with varying benefits and drawbacks that depend on the characteristics and use of the system. Below are some recommended approaches for controlling microbial growth in distribution systems:

- **Producing non-potable water low in carbonaceous material and nutrient content.** The primary energy source for pathogen regrowth is organic carbon measured as assimilable organic carbon, biodegradable dissolved organic carbon, total organic carbon, and other essential nutrients, including nitrogen (N), phosphorous (P), and iron (Fe); therefore, the primary means to reduce the regrowth potential of pathogens is to provide highly treated water. Reducing the potential for regrowth is more important in large-scale buildings or neighborhood-scale projects where there will be more residence time (creating more opportunities for regrowth) in distribution systems that supply non-potable water.
- **Producing highly disinfected non-potable water.** Low concentrations of microbes resulting from filtration and advanced means of disinfection have a reduced potential for regrowth if organic carbon levels are low. Otherwise, there may be a need for a residual disinfectant to manage growth in larger community systems that produce aerosols. Post-treatment disinfection with UV radiation is a recommended means of disinfection that does not increase levels of assimilable organic carbon or biodegradable dissolved organic carbon.
- **Using non-reactive, biologically stable materials of construction.** Avoid the use of corrosive materials or organic materials that tend to protect microorganisms from disinfection and enhance the regrowth environment by the adsorption of organic compounds.
- **Maintaining a residual disinfectant.** Different disinfectants offer advantages and disadvantages to overall water quality and system management. In general, a higher disinfectant residual provides lower regrowth. Many design and operation considerations are available for each specific system. It is recommended that a free chlorine residual of 0.2 milligrams per liter (mg/L) or monochloramine residual of 2 to 3 mg/L be maintained at or near the point of use to control microbial growth. Chloramine provides a better residual duration as compared to chlorine. Various combinations of UV, chlorine, chloramine, ozone, and hydrogen peroxide are beneficial for specific disinfection goals. Periodic shock treatments with disinfectants and continuous disinfection looping of reservoirs help reduce the potential for regrowth and manage issues with biofilms. Stagnation resulting from dead zones or prolonged periods of zero-flow or low flow that create long residence times and allow disinfectants to dissipate and sediments to deposit result in improved conditions for regrowth and should be avoided.

- **Cleaning storage tanks.** The required frequency of storage tank cleaning varies depending upon the quality of water stored, detention time in storage, temperature of the water, and nature of the tank. Tanks that are open to the atmosphere require more frequent cleaning.
- **Flushing the distribution system.** The required frequency of distribution system flushing varies depending upon the quality of water transmitted, detention time in the distribution system, temperature of the water, and nature of the distribution system components. Periodic flushing is a good means of both removing sediments and scouring pipe walls. System design must include means for easily flushing pipes as part of routine maintenance.
- **Controlling temperature.** Avoid the storage and distribution of non-potable water within 20°C to 45°C to reduce the potential for pathogen regrowth. Otherwise, consider a disinfection residual or point-of-use system, particularly if aerosols are generated.

The rainwater harvesting system designer and Person Responsible for Maintenance each should review published guidelines for the management of Legionella in distribution systems and implement as appropriate for each specific system. In particular, ANSI/ASHRAE Standard 188-2015 Legionellosis: Risk Management for Building Water Systems (2015) provides guidance on stormwater best management practices (BMPs) for both potable and non-potable water systems. It addresses management program responsibilities, system design, risk analysis, control mechanisms, monitoring, confirmation, and documentation. Although the ASHRAE Standard targets legionellosis, its rationales and approaches are applicable to all pathogens and health risks identified in this appendix.

## **N.6 Commissioning**

In the process of initializing a rainwater harvesting system, the system must be evaluated for leaks in the storage unit and the performance of the components of the treatment and distribution system. A commissioning report of the evaluation is required at the initial startup of the system and anytime the system is brought back online after cleaning, flushing, or a hiatus of use (e.g., winter shutdown).

## **N.7 Operational Monitoring and Reporting**

The Person Responsible for Maintenance, as identified in the Stormwater Management Plan (SWMP), must maintain the rainwater harvesting system in good working condition and assure adequate treatment of the harvested rainwater. All systems, with the exception of those installed in single-family homes, shall include continuous monitoring systems that are capable of determining if the rainwater harvesting system is operating within the design specification, and if all system components of the rainwater harvesting system are functional.

Data logs from continuous monitoring systems must be kept on file and produced upon request from DOEE. In addition, annual reports must be generated that identify the following:

- Significant maintenance activities;
- Treatment modifications;
- Outages and malfunctions (including reasons and durations); and

- Steps taken to mitigate or eliminate recurrence of outages and malfunctions.

If there is a change of personnel—Person Responsible for Maintenance—it is the responsibility, within 15 business days, of the owner of the rainwater harvesting system or her/his agent to update the DOEE Stormwater Database with the name and contact information of the new personnel.

An operation and maintenance manual that includes a schematic drawing of the system, standard operating procedures for the system, and maintenance schedule(s), as well as commissioning reports, field verification reports, and annual reports must be on site and produced upon request from DOEE.

## **N.8 Field Verification**

Field verification is a performance confirmation of a rainwater harvesting system. It can be accomplished by physically observing the collection, storage, and distribution system, and the treatment process components. It can also be conducted using challenge testing, including surrogate microorganisms or other non-biological surrogates and typically involves manual collection of water samples for microbial analysis to check system performance in achieving LRTs. While not specifically required, DOEE construction or maintenance inspections may include field verification testing to ensure that the rainwater harvesting system is achieving its LRTs, and that operational monitoring and control systems are functional.

## **N.9 Design Report**

A design report must be submitted with each rainwater harvesting system that includes, at a minimum, the following:

- Pathogen log<sub>10</sub> reduction target (Section N.2);
- Proposed treatment process and associated log<sub>10</sub> reduction value (Section N.3);
- Proposed testing procedure for VOCs, if applicable (Section N.4);
- Proposed storage and distribution management practices (Section N.5);
- Commissioning report (Section N.6);
- Identification of the Person Responsible for Maintenance (Section N.7);
- Operation and Maintenance Manual (Section N.7); and
- Reliability analysis that identifies the following:
  - ◆ How the equipment used to monitor treatment, operations, and water quality enables determination of whether the system is working as planned;
  - ◆ How the monitoring and controls of the system will enable the operator or automatic controls to intervene in the event of the production of off-specification water;
  - ◆ Remedies and provisions for operation disruption (e.g., power failures, vandalism, and excessive source contamination); and

- ◆ Unauthorized access limitations for the rainwater harvesting and distribution system.

## N.10 Treatment Design Examples

### N.10.1 Example 1: Rooftop Runoff for Landscape Irrigation

#### Step 1: Identify the Log<sub>10</sub> Reduction Targets for the Reference Pathogen Groups

Since the roof will not allow frequent public access, the water source qualifies as roof runoff rather than general runoff. No LRT is provided for enteric bacteria or parasitic protozoa, but an LRT of 3.5 is defined for enteric bacteria (see Table N.7).

Table N.7 Example 1 LRT for Roof Runoff

Source LRT	Virus	Protozoa	Bacteria
Roof Runoff	-	-	3.5

#### Step 2: Select a Treatment Process to Achieve the Log<sub>10</sub> Reduction Target

An ozone system with a CT value (the product of residual disinfectant concentration and contact time) of 0.04 mg • min/L can achieve 4-log<sub>10</sub> reduction of enteric bacteria. However, as all disinfection processes require removal of particles 10 microns or larger, a 10-micron cartridge filter or similar device will also be necessary (see Figure N.1 and Table N.8).

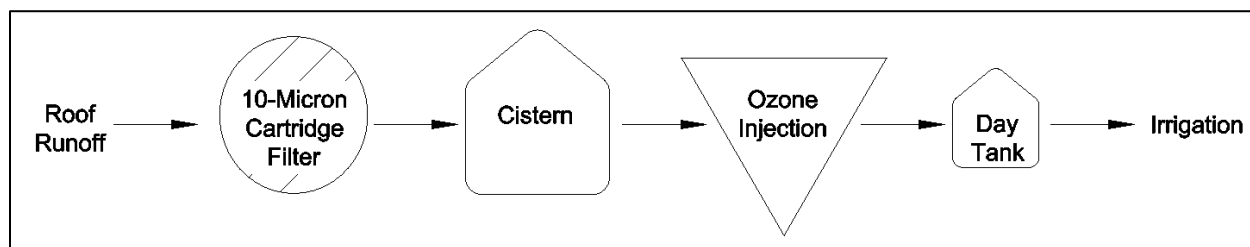


Figure N.1 Example 1 Treatment Schematic.

Table N.8 Example 1 LRV for Roof Runoff

Process Step LRV	Virus	Protozoa	Bacteria
Cartridge filter (10-micron)	0	0	0
Ozone (0.04 mg • min/L)	3	0	4



Total	3	0	4
-------	---	---	---

Alternative treatment trains that also could meet the required LRT include the following:

- Microfiltration (i.e., 6-log<sub>10</sub> reduction of bacteria).
- Sand filter with an equivalent effluent particle size distribution of 10 microns, followed by UV radiation with a dose of 40 to 60 mJ/cm<sup>2</sup> (i.e., 4-log<sub>10</sub> inactivation of bacteria).
- Cartridge filtration (10 microns), followed by chlorination with free chlorine with a CT value of 1.6 to 2.4 mg•min/L (i.e., 4-log<sub>10</sub> inactivation of bacteria).

**Step 3: Determine Storage and Distribution Management Practices**

For non-potable water systems, consider the chemical characteristics of roof runoff and storage conditions, as follows:

- Due to its high purity, roof runoff may result in the corrosion of components and fixtures of the metallic distribution system. If any metallic pipe, fittings, solder, or fixtures are used that may be subject to corrosion from contact with corrosive water, then modify the water system or add a corrosion inhibitor to the non-potable water supply.
- If the temperature of water in the non-potable water distribution system exceeds 25°C (which is a condition that could promote the growth of opportunistic pathogens like Legionella), then maintain a free chlorine residual of 0.2 milligrams per liter (mg/L) or chloramine residual of 0.5 mg/L at or near the point of use.

**Step 4: Identify Maintenance and Monitoring Requirements and Schedule of Activities**

These will vary based on the specific equipment and devices included in each design.

**Step 5: Submit Design Report and SWMP**

**N.10.2 Example 2: General Runoff for Landscape Irrigation**

**Step 1: Identify the Log<sub>10</sub> Reduction Targets for the Reference Pathogen Groups**

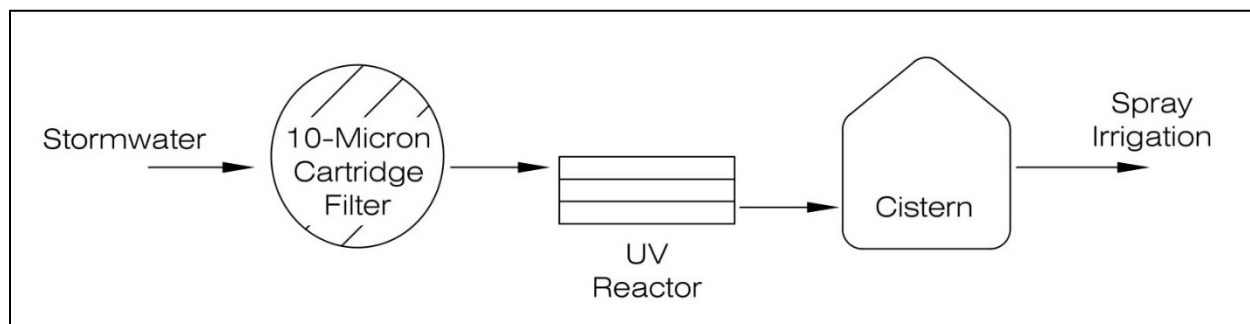
The water source is stormwater that is considered to be general runoff. The LRT for enteric viruses is 3.0, the LRT for protozoa is 2.5, and the LRT for enteric bacteria is 2.0 (see Table N.9).

**Table N.9 Example 2 LRT for General Runoff**

Source LRT	Virus	Protozoa	Bacteria
General Runoff	3.0	2.5	2.0

**Step 1: Select a Treatment Process to Achieve the Log<sub>10</sub> Reduction Target**

An ultraviolet radiation system with a CT value of 140–150 mg • min/L can achieve 3-log<sub>10</sub> reduction of bacteria. However, as all disinfection processes require removal of particles 10 microns or larger, a 10-micron cartridge filter or similar device will also be necessary (see Figure N.2 and Table N.10).



**Figure N.2 Example 2 Treatment Schematic.**

Table N.10 Example 2 LRV for General Runoff Process Step LRV	Virus	Protozoa	Bacteria
Cartridge filter (10-micron)	0	0	0
Ultraviolet radiation (140–150 mJ/cm <sup>2</sup> )	3	4	4
Total	3	4	4

Alternative treatment trains that also could meet the required LRT include the following:

- Microfiltration (i.e., 6-log<sub>10</sub> reduction of bacteria).
- Sand filter with an equivalent effluent particle size distribution of 10 microns, followed by UV radiation with a dose of 40 to 60 mJ/cm<sup>2</sup> (i.e., 4-log<sub>10</sub> inactivation of bacteria).
- Cartridge filtration (3 microns), followed by chlorination with free chlorine with a CT value of 3.0 to 3.5 mg • min/L (i.e., 4-log<sub>10</sub> inactivation of bacteria).

**Step 2: Determine Storage and Distribution Management Practices**

For non-potable water systems, consider the chemical characteristics of treated stormwater as follows:

- In systems that require the presence of free chlorine to meet the LRTs, the potential for a variable content of ammonium can be problematic. If possible, identify and control sources of ammonium (e.g., fertilizers and runoff from golf courses and other grassed areas). If the temperature of water in the non-potable water distribution system exceeds 25°C (which is a condition that could promote the growth of opportunistic pathogens like Legionella), then

maintain a free chlorine residual of 0.2 milligrams per liter (mg/L) or chloramine residual of 0.5 mg/L at or near the point of use.

**Step 3: Identify Maintenance and Monitoring Requirements and Schedule of Activities**

These will vary based on the specific equipment and devices included in each design.

**Step 4: Design Report and SWMP**

**N.10.2 Example 3: General Runoff for Indoor Use**

**Step 1: Identify the Log<sub>10</sub> Reduction Targets for the Reference Pathogen Groups**

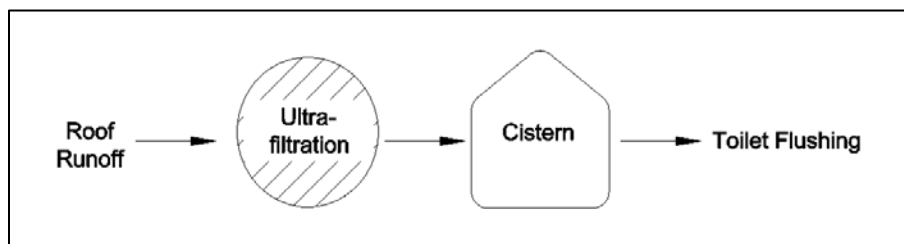
The proposed rainwater harvesting system will capture runoff from two different areas on a rooftop. The first area will have no public access, but the second area includes a patio area that is designed for public access. The combined water from the two areas is therefore considered “general runoff,” and will need to be treated accordingly. The LRT for both enteric viruses and protozoa is 3.5, and the LRT for enteric bacteria is 3.0. (see Table N.11).

**Table N.11 Example 3 LRT for General Runoff**

Source LRT	Virus	Protozoa	Bacteria
Roof Runoff	3.5	3.5	3.0

**Step 2: Select a Treatment Process to Achieve the Log<sub>10</sub> Reduction Target**

An ultrafiltration system can achieve 6-log<sub>10</sub> reduction of viruses, protozoa, and bacteria (see Figure N.2 and Table N.12).



**Figure N.2 Example 3 Treatment Schematic.**

**Table N.12 Example 3 LRV for General Runoff**

Process Step LRV	Virus	Protozoa	Bacteria
Ultra-filtration	6	6	6
Total	6	6	6

Alternative treatment trains that also could meet the required LRT include the following:

- Nanofiltration.
- Cartridge filter (1 micron) and ultraviolet radiation (180-200 mJ/cm<sup>2</sup>)

The only alternative processes that can also meet the required LRTs are nanofiltration and reverse osmosis.

***Step 3: Determine Storage and Distribution Management Practices***

For non-potable water systems, consider the chemical characteristics of roof runoff and storage conditions, as follows:

- Due to its high purity, roof runoff may result in the corrosion of components and fixtures of the metallic distribution system. If any metallic pipe, fittings, solder, or fixtures are used that may be subject to corrosion from contact with corrosive water, then modify the water system or add a corrosion inhibitor to the non-potable water supply.
- If the temperature of water in the non-potable water distribution system exceeds 25°C (which is a condition that could promote the growth of opportunistic pathogens like Legionella), then maintain a free chlorine residual of 0.2 milligrams per liter (mg/L) or chloramine residual of 0.5 mg/L at or near the point of use.

***Step 4: Identify Maintenance and Monitoring Requirements and Schedule of Activities***

These will vary based on the specific equipment and devices included in each design.

***Step 5: Submit Design Report and SWMP***

**N.10.3 Example 4: Roof Runoff for Cooling Towers**

***Step 1: Identify the Log<sub>10</sub> Reduction Targets for the Reference Pathogen Groups***

As there is not public exposure to the harvested rainwater, there are no initial treatment requirements. Chlorination may still be required to control the growth of opportunistic pathogens (see Step 2).

***Step 2: Determine Storage and Distribution Management Practices***

For non-potable water systems, consider the chemical characteristics of roof runoff and storage conditions, as follows:

- Due to its high purity, roof runoff may result in the corrosion of components and fixtures of the metallic distribution system. If any metallic pipe, fittings, solder, or fixtures are used that may be subject to corrosion from contact with corrosive water, then modify the water system or add a corrosion inhibitor to the non-potable water supply.
- If the temperature of water in the non-potable water distribution system exceeds 25°C (which is a condition that could promote the growth of opportunistic pathogens like Legionella), then maintain a free chlorine residual of 0.2 milligrams per liter (mg/L) or chloramine residual of 0.5 mg/L at or near the point of use.

***Step 3:* Identify Maintenance and Monitoring Requirements and Schedule of Activities**

These will vary based on the specific equipment and devices included in each design.

***Step 4:* Submit Design Report and SWMP.**

## **N.11 References**

San Francisco Department of Public Health (2016). Director's Rules and Regulations Regarding the Operation of Alternate Water Source Systems.

Sharvelle, S.; Ashbolt, N.; Clerico, E.; Hultquist, R.; Leverenz, H.; and Olivieri, A. (2017). Risk-Based Framework for the Development of Public Health Guidance for Decentralized Non-Potable Water Systems. Prepared by the National Water Research Institute for the Water Environment & Reuse Foundation. Alexandria, VAWE&RF Project NoSIWM10C15.

U.S. Environmental Protection Agency (2009). National Primary Drinking Water Regulations EPA 816-F-09-004.



# Appendix O Land Cover Designations

## O.1 General Notes

The retention standard approach taken in this guidebook for on-site stormwater management recognizes the ability of pervious land covers to manage some, or all, of the rainwater that falls on it. This is termed "land abstraction" in this appendix. The concept is discussed as "existing retention" or "pre-project retention" in chapters and appendices related to the off-site retention program. To facilitate the design, review, construction, and enforcement of site-designated land cover, land abstraction has been divided into two types of land covers: natural cover and compacted cover. The preservation and the creation of land covers with either of these designations are treated equally in this guidance manual. The designation of natural cover assumes these lands will generate zero stormwater runoff for a design rain event. The designation of compacted cover assumes these lands will generate 25% stormwater runoff for a design rain event. The minimum area threshold for the natural cover designation is 1,500 square feet, with a minimum length of 30 feet. All land cover designations must be recorded in the declaration of covenants.

## O.2 Existing Natural Cover Requirements

A site claiming natural cover based on the preservation of existing conditions must ensure conditions remain undisturbed to preserve hydrologic properties equal to or better than meadow in good condition. Preservation areas for natural cover may include the following:

- Portions of residential yards in forest cover that will not be disturbed during construction
- Community open space areas that will not be mowed routinely, but left in a natural vegetated state (can include areas that will be rotary mowed no more than two times per year)
- Utility rights-of-way that will be left in a natural vegetated state (can include areas that will be rotary mowed no more than two times per year)
- Other areas of existing forest and/or open space that will be protected during construction and that will remain undisturbed

## O.3 Planting Requirements for the Creation of Natural Cover

- Every 1,500 square feet of created natural area shall be vegetated according to the following options of plant material quantity:
  - ◆ 1 native shade tree: 1.5-inch caliper (minimum), or
  - ◆ 1 native multi-trunk tree: 8-foot height (minimum), or
  - ◆ 2 native ornamental trees: 6-foot height (minimum), or
  - ◆ 6 native shrubs: 5-gallon container size (minimum), or

- ◆ 50 native perennial herbaceous plants: 1-gallon container size (minimum), or
  - ◆ 1 native ornamental tree: 6- to 10-foot height (minimum), and 25 native perennial herbaceous plants: 1-gallon container size (minimum), or
  - ◆ 3 native shrubs: 5-gallon container size (minimum), and 25 native perennial herbaceous plants: 1-gallon container size (minimum), or
  - ◆ Steep slope greater than 6% grade will require additional plantings, soil stabilization, or a terracing system.
- Whip and seedling stock may be used (when approved by DOEE) as a site's natural cover creation if a stream bank stabilization opportunity falls within the site's footprint. In this instance, whips or seedlings must be planted at a minimum density of 700 plants per acre, and at least 55% of these plants must remain at the end of the 2-year management period.
  - Natural regeneration (i.e., allowing volunteer plants to propagate from surrounding natural cover as a cover creation technique) may be allowed by DOEE when 75% of the proposed planting area is located within 25 feet of adjoining forest, and the adjoining forest contains less than 20% cover of invasive exotic species. In this case, supplemental planting must ensure a density of 400 seedlings per acre.
  - All plant materials used must be native to the mid-Atlantic region and must be installed in areas suitable for their growth. Lists of native species of shrubs, grasses, and wildflowers are published in the US Fish and Wildlife Service (2009) Native Plants for Wildlife Habitat and Conservation Landscaping: Chesapeake Bay Watershed. There are several websites that may be consulted to select the most appropriate plantings for the District;
    - ◆ <http://www.wildflower.org/collections/collection.php?collection=DC>
    - ◆ <http://www.nativeplantcenter.net/>
    - ◆ <https://www.mdflora.org/aboutnatives.html>
    - ◆ <https://www.fws.gov/chesapeakebay/bayscapes/bsresources/bs-nativeguides.html>
  - Plants can be irrigated until established.

#### **O.4 Stormwater Management Plans and Natural Cover**

Sites using preservation of existing areas for the natural cover designation shall include on their Stormwater Management Plan (SWMP) a tree and vegetation survey, identification of location, and extent of preservation areas. Depending on the extent of the preservation area, DOEE may require the SWMP to include a more detailed schedule for retained trees, noting the tree species, size, canopy, condition, and location.

The SWMP will include the identification of material and equipment staging areas and parking areas. Material and equipment staging areas and parking areas must be sufficiently offset for preservation areas to ensure no adverse impacts.

For areas maintained as meadow in good condition, the SWMP shall document either the preservation of existing conditions or the creation of meadow conditions. A plan submission claiming meadow preservation will note the existing meadow boundaries and include a field



survey of the richness and diversity of existing plant species and the existing soil conditions. A plan submission claiming meadow creation will note the proposed meadow boundaries, the planting and/or seeding species methods, and provide a soil amendments plan as specified in Appendix K - Soil Compost Amendment Requirements.

The 2013 Stormwater Rule (21 DCMR, Chapter 5) requires establishing a buffer of native vegetation within 25 feet of a water body. This can be accomplished by meeting the planting requirements for natural cover as described in Section N.3 or by construction of a living shoreline that meets the requirements identified in the District's Living Shoreline specification. Living shorelines that meet these specifications are classified as natural cover.

## **O.5 Construction Requirements for Natural Cover Designation**

The preservation of lands designated as natural cover—such as undisturbed portions of yards, community open space, and any other areas designated on a site's SWMP as preserved natural cover—must be shown outside the limits of disturbance on the site's Soil Erosion and Sediment Control Plan. These areas must be clearly demarcated with signage prior to commencement of construction on the site on the site and with fencing during construction.

The creation of lands designated as natural cover as part of a public right-of-way (PROW) project and on sites where soils were not protected from compaction during construction the soils must be conditioned prior to planting with soil compost amendments as prescribed in Appendix K - Soil Compost Amendment Requirements.

For maximum survivability, planting of trees, shrubs, and herbaceous vegetation for the creation of natural cover should occur only during the fall and early spring (i.e., September through November and March through May). The work should be done only under the supervision of someone qualified and skilled in landscape installation (see Section 3.14, "Tree Planting and Preservation" for details on qualifications). Proper maintenance of the materials after installation will be key in ensuring plants survival. Prior to inspection, all trees and shrubs planted must be alive and in good health, and native grass and wildflower seeds must have been sown at adequate densities and at the right time of year for each species.

Once a natural cover designation has been assigned to a portion of regulated development site, that area will need to be recorded in the declaration of covenants, documented at the site prior to construction activities, protected during construction activities, and permanently protected/maintained for the life of the regulated site.

Root pruning and fertilizing are examples of preconstruction activities. These measures aim to increase the wellbeing of trees and prepare them for higher stress. Prior to beginning construction, temporary devices such as fences or sediment controls are installed and remain throughout the construction phase. Some devices, like retaining walls and root aeration systems may remain permanently. For example, if part of a root system is collapsed by a built road, permanent aeration may be necessary for the tree to remain healthy.

## **O.6 Maintenance Requirements for Natural Cover Designation**

All areas that will be considered natural cover for stormwater purposes must have documentation that prescribes that the area will remain in a natural, vegetated state. Appropriate documentation includes subdivision covenants and restrictions, deeded operation and maintenance agreements and plans, parcels of common ownership with maintenance plans, third-party protective easements within the PROW, or other documentation approved by DOEE.

While the goal is to have natural cover areas remain undisturbed, some activities may be prescribed in the appropriate documentation, as approved by DOEE, such as forest management, control of invasive species, replanting and revegetation, passive recreation (e.g., trails), limited bush hogging to maintain desired vegetative community, etc.

## **O.7 Compacted Cover Designation**

The compacted cover designation can apply to all site areas that are disturbed and/or graded for eventual use as managed turf or landscaping. Examples of compacted cover include lawns, portions of residential yards that are graded or disturbed and maintained as turf (including yard areas), residential utility connections, and PROW. Landscaping areas intended to be maintained as vegetation other than turf within residential, commercial, industrial, and institutional settings are also considered compacted cover if regular maintenance practices are employed.

Soil must be vegetated and at least six inches deep to be considered compacted cover if above a BMP or structure.

## **O.8 Impervious Cover Designation**

The impervious cover designation applies to all surface areas that have been compacted or covered with a layer of material that impedes or prevents the infiltration of water into the ground, examples include conventional streets, parking lots, rooftops, sidewalks, pathways with compacted sub-base, and any concrete, asphalt, or compacted gravel surface and other similar surfaces. The surface area of all surface BMPs, except disconnection areas, are also considered to be impervious cover. For BMPs with ponding, the area of the top of ponding should be considered the BMP surface area.

# Appendix P Geotechnical Information Requirements for Underground BMPs

## P.1 General Notes Pertinent to All Geotechnical Testing

A geotechnical report is required for all underground stormwater best management practices (BMPs), including infiltration-based practices, filtering systems, and storage practices, as well as stormwater ponds and wetlands. The following must be considered when producing this report.

- Testing is to be conducted at the direction of a qualified professional. This professional shall either be a registered professional engineer, soil scientist, or geologist and must be licensed in the District of Columbia, Maryland, or Virginia.
- Soil boring or test pit information is to be obtained from at least one location on the site. Additional borings or test pits are required within the proposed BMP facility under three conditions: (1) when the soils or slopes vary appreciably from the findings in the initial boring or test pit, (2) when the groundwater level is found to be significantly higher than the initial boring or test pit indicated, and (3) when the groundwater level may adversely affect the performance of the proposed BMP facilities. However, the location, number, and depth of borings or test pits shall be determined by a qualified professional, and be sufficient to accurately characterize the site soil conditions.
- Depth to the groundwater table with a reading after 24 hours must be included in the boring logs/geotechnical report.
- Laboratory testing must include grain size analysis from a soil sample taken within 2 feet from the bottom of the proposed BMP. Additional tests may be necessary where foundation soils or slopes are potentially unstable based on the discretion of the qualified professional.
- The geotechnical report must include soil descriptions from each boring or test pit, and the laboratory test results for grain size. Based upon the proposed development, the geotechnical report may also include evaluation of settlement, bearing capacity, and slope stability of soils supporting the proposed structures.
- All soil profile descriptions should provide enough detail to identify the boundary and elevations of any problem (boundary/restrictions) conditions such as fills and seepage zones, type and depth of rock, etc.

In addition to the testing requirements described above, infiltration tests must be performed for all BMPs in which infiltration will be relied upon, including permeable pavement systems, bioretention, infiltration, and dry swales. Specific requirements for infiltration testing are discussed below.

## P.2 Initial Feasibility Assessment

The feasibility assessment is conducted to determine whether full-scale infiltration testing is necessary, screen unsuitable sites, and reduce testing costs. However, a designer or landowner may opt to skip the initial feasibility assessment at his or her discretion and begin with soil borings.

The initial feasibility assessment typically involves existing data, such as the following:

- On-site septic percolation testing, which can establish historic percolation rates, water table, and/or depth to bedrock. Percolation tests are different than tests for coefficient of permeability or infiltration rate;
- Previous geotechnical reports prepared for the site or adjacent properties; or
- Natural Resources Conservation Service (NRCS) Soil Mapping.

If the results of initial feasibility assessment show that a suitable infiltration rate (typically greater than 0.5 inch per hour) is possible or probable, then test pits must be dug or soil borings drilled to determine the saturated hydraulic conductivity ( $K_{sat}$ ).

### **P.3 Test Pit/Boring Requirements for Infiltration Tests**

- Excavate a test pit or drill a standard soil boring to a depth of 2 feet below the proposed BMP bottom.
- Do not construct, maintain, or abandon a well in a manner that may create a point source or non-point source of pollutants to waters of the District, impair the beneficial uses of waters of the District, or pose a hazard to public health and safety or the environment (21 DCMR, Chapter 18, Section 1801.2). Therefore, if contaminated soil or materials indicative of contamination are noticed at the site, in accordance with 21 DCMR, Chapter 18, Section 1802.4, and 1832.2, stop work, report the findings to DOEE Inspections and Enforcement Division, undertake any Department-ordered corrective actions, and obtain a DCRA well construction building permit to properly abandon the borehole in accordance with 21 DCMR §§ 1831.4 through 1831.6 and 1831.8 through 1831.14.
- Determine depth to the groundwater table if within 2 feet of proposed BMP bottom.
- Determine Unified Soil Classification System (USCS) or United States Department of Agriculture (USDA) textures at the proposed bottom to 2 feet below the bottom of the BMP.
- Determine depth to bedrock (if within 2 feet of proposed BMP bottom).
- Include the soil description in all soil horizons. Perform the infiltration test at the proposed bottom of the BMP. If any of the soil horizons below the proposed bottom of the infiltration practice (within 2 feet) appear to be a confining layer, additional infiltration tests must be performed on this layer (or layers), following the procedure described below.
- The location of the test pits or borings shall correspond to the BMP locations. A map or plan that clearly and accurately indicates the location(s) of the test pits or soil borings must be provided with the geotechnical report.

Table P.1 indicates the number of test pits or soil borings and subsequent infiltration tests that must be performed per BMP. In cases where multiple BMPs are proposed in one area with

generally uniform conditions, a circular shape that fully encompasses all of the BMPs may be substituted for the “area of practice” that determines the number of required infiltration tests.

**Table P.1 Number of Infiltration Tests Required per BMP**

Area of Practice (ft <sup>2</sup> )	Minimum Number of Test Pits/Soil Borings
< 1,000	1
1,000–1,999	2
2,000–9,999	3
≥ 10,000	Add 1 test pit/soil boring for each additional 10,000 ft <sup>2</sup> of BMP.

When one test pit or boring is required, it must be located as near to the testing area as possible. When more than one test pit or boring is necessary for a single BMP or area, the pit or boring locations must be equally spaced throughout the proposed BMP area, as directed by the qualified professional. The reported saturated hydraulic conductivity for a BMP shall be the median or geometric mean (area-weighted average) of the observed results from the soil boring or test pit locations.

#### **P.4 Infiltration Testing Requirements**

The following tests are acceptable for use in determining soil infiltration rates. The geotechnical report shall include a detailed description of the test method and published source references:

- Constant Head Bore-Hole Infiltration Tests (also referred to as bore-hole permeameter tests and constant-head well permeameter tests). These types of tests determine saturated hydraulic conductivity (coefficient of permeability) by measuring the rate of water flow to a borehole. Analytical solutions utilize principles of Darcy’s Law, borehole geometry, and head (or multiple heads) of water in determining saturated hydraulic characteristics. Where the soil characteristics meet all of the above described requirements for infiltration BMPs, the hydraulic gradient element of Darcy’s Law is often estimated as 1 for determining infiltration rate.

One published standard developed by the United States Bureau of Reclamation for this method is USBR 7300-89. Some of the commercially available equipment is listed below:

- ◆ Amoozemeter
  - ◆ Guelph Permeameter
  - ◆ Johnson Permeameter
- Maryland Stormwater Design Manual, Appendix D.1 Testing Requirements for Infiltration, Bioretention, and Sand Filter Subsoils, as modified below. The data obtained from this infiltration testing procedure shall be used to calculate the saturated hydraulic conductivity (see Section P.5, “Saturated Hydraulic Conductivity Calculations”).

1. Install solid casing in the boring or test pit to the proposed BMP bottom or other required test depth (i.e. confining layer encountered within 2 feet below the BMP bottom). When

installing casing, drive the casing between 3 to 5 inches below the test surface to promote a good casing-to-soil seal.

2. Remove any smeared, soiled surfaces, and provide a natural soil interface into which water may infiltrate. Remove all loose material from the casing. At the tester or registered professional's discretion, a 2-inch layer of coarse sand or fine gravel may be placed to protect the bottom from scouring and sediment. Fill the casing with clean, potable water 24 inches above the test surface (24 inches of head), and allow to presoak for 24 hours.
3. Protect the open borehole with suitable cover such as a sanitary well cap and steel plate with surrounding sandbags to prevent the introduction of surface water runoff, trash, debris, and other pollutants.
4. Twenty-four hours later, refill the casing with approximately 24 inches of clean water (24 inches of head), and monitor the water level for 1 hour, recording the depth of water at the beginning and end of the test.
5. Repeat step 4 (filling the casing each time) three additional times, for a total of four observations. At the registered professional's discretion, the saturated hydraulic conductivity calculations may be performed based on the values recorded during the average of the four readings or the last observation. The testing interval can be increased at the discretion of the registered professional.

All soil borings and test pits shall be properly backfilled after conclusion of the tests. A person shall not construct, maintain, or abandon a well in a manner that may create a point source or non-point source of pollutants to waters of the District, impair the beneficial uses of waters of the District, or pose a hazard to public health and safety or the environment (21 DCMR, Chapter 18, Section 1801.2). To prevent a soil boring from becoming a conduit for stormwater or other contaminants to enter groundwater and create a low-permeability seal against vertical fluid migration, follow these steps:

1. Using a positive displacement technique, inject a sodium-based bentonite slurry through a tremie pipe at least 1 inch in diameter starting at the bottom of the borehole. The slurry shall be composed of 2 pounds of sodium-based bentonite powder to 1 gallon of water.
2. If the borehole is too narrow to accommodate a tremie pipe or the borehole is less than 10 feet deep, slowly place uncoated, medium-sized, sodium-based bentonite chips in the borehole to create a 2-foot lift of chips measured from the bottom of the borehole.
3. Tamp down the bentonite chips to prevent bridging.
4. Using a ratio of 1 gallon of water to 12.5 pounds of bentonite chips, add potable water to the borehole and allow 15 to 30 minutes to elapse to ensure proper hydration of the bentonite chips.
5. Adjust these instructions as necessary in accordance with the manufacturer's instructions, providing that the resulting seal will have an effective hydraulic conductivity of no more than  $1 \times 10^{-7}$  cm/s.
6. The process should be repeated until the boring is filled 1 to 2 feet from the ground surface.

7. The remainder of the borehole should be backfilled with material to match the surrounding cover and must not include the use of a coal-tar product.

Further details are provided in 21 DCMR §§ 1831.4 through 1831.6 and 1831.8 through 1831.14.

An infiltration test does not require a well permit in accordance with the current well construction, maintenance, and abandonment regulations set forth in 21 DCMR, Chapter 18 if the following apply:

- The test is conducted to a depth of 15 feet or less below the ground surface, and
- A Professional Engineer licensed in the District of Columbia certifies the hydraulic conductivity and that the test was carried out in compliance with this guidance and accepted professional standards.

Note: If the infiltration testing procedure reveals smells or visual indications of soil or groundwater contamination then the boring or test hole must be filled in accordance with wellhead protection best practices, unless laboratory analysis determines groundwater or soil is not contaminated, as defined in the District of Columbia Brownfield Revitalization Act of 2000, as amended (D.C. Official Code §§ 8-631 *et seq.*).

## **P.5 Saturated Hydraulic Conductivity Calculations**

To convert the field infiltration measurements to a saturated hydraulic conductivity value ( $K_{sat}$ ), the following calculations must be performed.

$$K_{sat} = \frac{\pi D}{11(t_2 - t_1)} \times \ln\left(\frac{H_1}{H_2}\right)$$

where:

$K_{sat}$	= saturated hydraulic conductivity (in/hr)
$D$	= casing diameter (in) (minimum 4 inches)
$t_2$	= recorded end time of test (hr)
$t_1$	= recorded beginning time of test (hr)
$H_1$	= head in casing measured at time $t_1$ (ft)
$H_2$	= head in casing measured at time $t_2$ (ft)

This equation was adapted by the U.S. Bureau of Reclamation in 1975 from Lambe and Whitman, 1969.

## **P.6 Infiltration Restrictions**

If a Phase I Environmental Site Assessment identifies a Recognized Environmental Concern at a site indicating that site contamination is likely or present; or if DOEE is aware of upgradient or downgradient contaminant plumes, the presence of a brownfield or historic hotspot use, such as any of the following current or previous uses, then an impermeable liner must be used for BMPs, and infiltration is prohibited:

- Leaking underground storage tank (LUST);
- Above ground storage tanks (AST);
- Gas stations;
- Vehicle maintenance or repair facility;
- Dry cleaner;
- Transformer sub-station;
- Waste transfer or holding facility;
- Print shop;
- Chemical storage warehouse;
- Illicit hazardous wastes generator;
- Greenhouse with unlined floor;
- Septic system;
- Cement or asphalt plant; or
- Dump or landfill.

If an ASTM Phase II Environmental Site Assessment is performed based on a DOEE-approved workplan in accordance with 21 DCMR, Chapter 19, Section 1901.1 and DOEE reviews the results and determines that stormwater infiltration BMPs may impact on-site contamination by the following means, then an impermeable liner must be used for BMPs, and infiltration is prohibited:

- Spreading of contamination vertically or horizontally at the site;
- Increasing on-site groundwater contamination by leaching contaminants from the soil;
- Causing or enhancing contaminant migration to go offsite;
- Interfering with contaminant remedial activities;
- Decreasing or reversing the natural degradation of contaminants; or
- Causing a pollutant discharge to a surface water body.

If DOEE concludes there is no evidence of a Recognized Environmental Condition based on ASTM Phase I and II Environmental Site Assessments conducted in accordance with 21 DCMR § 1901.1, and there is no current site use that could result in the foreseeable creation of a Recognized Environmental Concern, then impermeable liners are not required, and infiltration is not restricted.

See Figure P.1 for a graphic depiction of the process for determining infiltration restrictions.



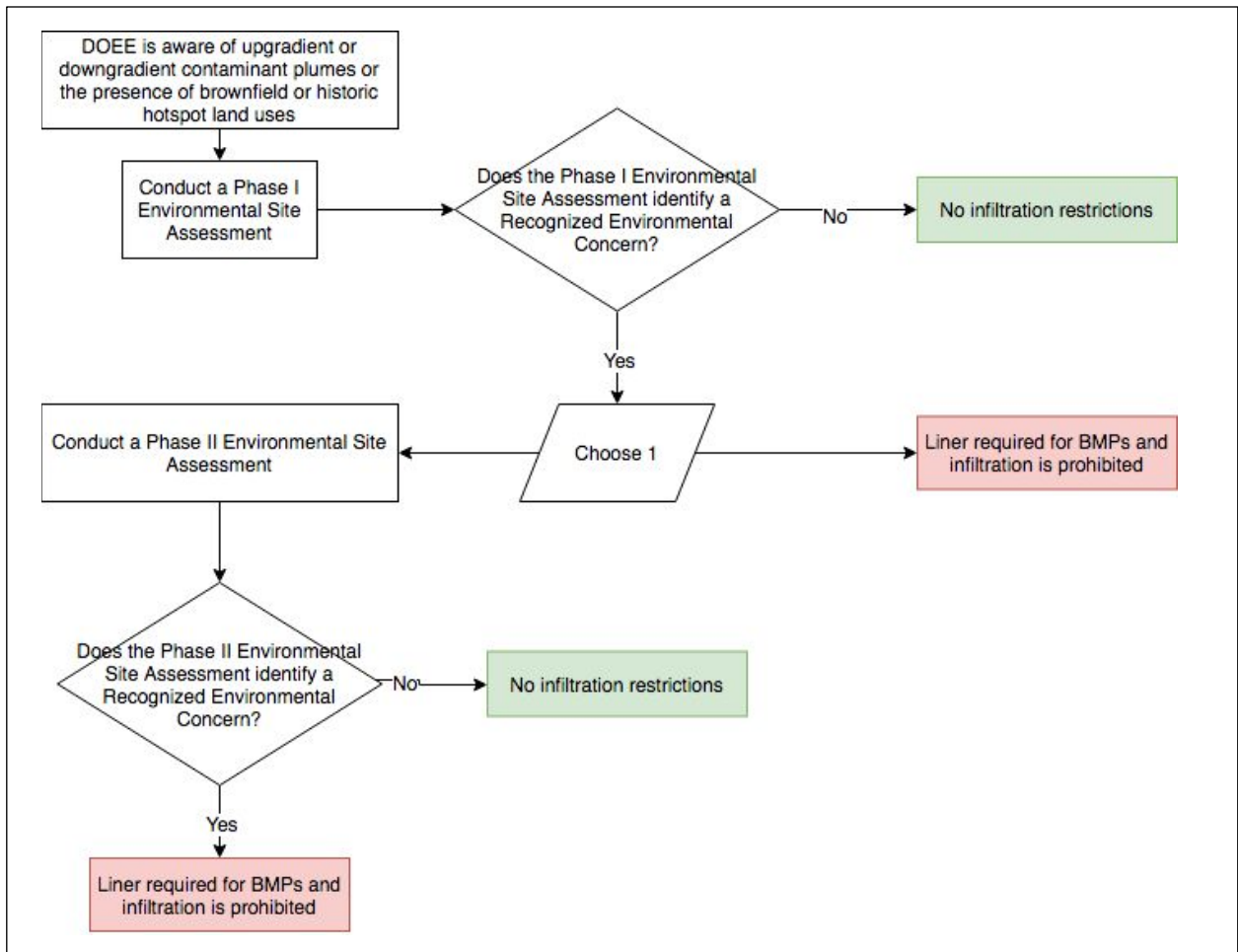


Figure P.1 Infiltration restrictions related to site contamination.



# Appendix Q Stormwater Hotspots

## Q.1 Stormwater Hotspots

Stormwater hotspots are defined as commercial, industrial, institutional, municipal, or transport-related operations that produce higher levels of stormwater pollutants, and/or present a higher potential risk for spills, leaks, or illicit discharges. The following operations are classified as stormwater hotspots operations in the District of Columbia:

H-1 Vehicle Maintenance and Repair

H-2 Vehicle Fueling

H-3 Vehicle Washing

H-4 Outdoor Materials Loading and Unloading

H-5 Outdoor or Bulk Material Storage

If any of the above operations are expected to occur in areas that will receive rainfall or runoff on the proposed site for which a Stormwater Management Plan (SWMP) is required, the Stormwater Hotspot Cover Sheet must be completed. Further, if a Construction General Permit Stormwater Pollution Prevention Plan (SWPPP) was not required or the SWPPP does not cover operational pollution prevention practices, then the Stormwater Hotspot Checklist must be submitted with the SWMP.

This appendix contains the following information:

- Stormwater Hotspot Cover Sheet
- Stormwater Hotspot Checklist
- Hotspot operation pollution prevention profile sheets for operations H-1 through H-5

## Q.2 Stormwater Hotspot Cover Sheet



**GOVERNMENT OF THE DISTRICT OF COLUMBIA**  
*Department of Energy and Environment*  
*1200 First Street NE, Fifth Floor, Washington DC 20002*

### *Stormwater Hotspot Cover Sheet*

---

*Project Name:* \_\_\_\_\_

*Applicant Name:* \_\_\_\_\_

*Date:* \_\_\_\_\_

*Please indicate the appropriate hotspot operations for your project (check all that apply). If none apply check N/A.*

#### **Hotspot Operations:**

- Vehicle Maintenance and Repair (H-1)
- Vehicle Fueling (H-2)
- Vehicle Washing (H-3)
- Outdoor Materials Loading and Unloading (H-4)
- Outdoor or Bulk Material Storage (H-5)
- N/A

*If "N/A" is checked, please include this sheet only with plan submittal.*

*Otherwise, please indicate which of the following items are being included with the submittal of the Stormwater Management Plan (SWMP). **Note: If a SWPPP has not been completed or the SWPPP does not cover operational pollution prevention practices, then the Stormwater Hotspot Checklist must be completed for the SWMP submittal to be considered complete.***

- A completed Construction General Permit Stormwater Pollution Prevention Plan (SWPPP)
- A completed **Stormwater Hotspot Checklist**

**Q.3 Stormwater Hotspot Checklist**

***Stormwater Hotspot Checklist***

*Instructions: Complete the following site information:*

	<b>Requirement</b>	<b>Description</b>
<b>Site Description</b>	List the type of facility and facility address	
<b>Site Operations</b>	Describe the operations to be conducted on site.	
<b>Receiving Waters</b>	Name(s) of the receiving water(s). If drains to a municipal storm sewer system, include ultimate receiving waters.	
<b>Site Materials</b>	Significant materials to be stored on-site (specify indoor or outdoor storage)	
<b>Stormwater Management Practices</b>	List the stormwater BMPs being used to treat runoff from the site. Where appropriate, include description of design modifications appropriate for treatment of hotspot runoff.	
<b>Spill Prevention and Response</b>	Describe methods to prevent spills along with clean-up and notification procedures.	
<b>Employee Education Program</b>	Description of employee orientation and education program.	

**Instructions:** Fill in the appropriate page number(s) from the site plans where the following site elements are clearly indicated.

Site Elements	Site Plan Sheet Number(s)	Check if N/A	Approved (for official use only)
Material loading and access areas			
Material storage and handling areas			
Cleaning and maintenance areas			
Vehicle or machinery storage areas			
Vehicle or machinery maintenance/service areas			
Treatment or disposal areas for significant materials			
Hazardous waste storage areas			
Areas of outdoor manufacturing			
Stormwater management calculations			
Contributing drainage area outline for each stormwater inlet or structure			
Stormwater BMPs			
BMP maintenance schedules and agreements			
Spill Prevention and Response Kits			
Facility inspection agreements for inspections of areas where potential spills of significant materials or industrial activities can impact stormwater			
<i>For official use only:</i>			
<b>Date of Submission:</b> _____ <b>Date Received:</b> _____	<b>Reviewed by:</b> _____ <b>Reviewed on:</b> _____		<b>Plan Accepted:</b> Y / N

**Instructions:** Complete this table only if operation H-1 was checked on Page P.2.

<b>H-1 Vehicle Maintenance and Repair</b>			
<b>Description of Operation</b>			
<b>Requirement</b>	<b>Description of pollution prevention mechanism or BMP to be implemented</b>	<b>Site Plan Sheet Number(s)</b>	<b>Approved (for official use only)</b>
Provide locations for recycling collection of used antifreeze, oil, grease, oil filters, cleaning solutions, solvents, batteries, and hydraulic and transmission fluids			
Cover all vehicle and equipment repair areas with a permanent roof or canopy.			
Connect outdoor vehicle storage areas to a separate stormwater collection system with an oil/grit separator, sand filter, or other accepted pretreatment device or BMP.			
Designate a specific location for outdoor maintenance activities that is designed to prevent stormwater pollution (paved, away from storm drains, and with stormwater containment measures)			
Stencil or mark storm drain inlets with "No Dumping, Drains to _____" message			

<i>For official use only:</i>		
<b><i>Date of Submission:</i></b> _____	<b><i>Reviewed by:</i></b> _____	<b><i>Plan Accepted: Y / N</i></b>
<b><i>Date Received:</i></b> _____	<b><i>Reviewed on:</i></b> _____	

**Instructions:** Complete this table only if operation H-2 was checked on Page Q.2.

<b>H-2 Vehicle Fueling</b>			
<b>Description of Operation</b>			
<b>Requirement</b>	<b>Description of pollution prevention mechanism or BMP to be implemented</b>	<b>Site Plan Sheet Number(s)</b>	<b>Approved (for official use only)</b>
Cover fueling stations with a canopy or roof to prevent direct contact with rainfall.			
Design fueling pads to prevent the run-on of stormwater and pretreat any runoff with an oil/grit separator, sand filter, or other accepted pretreatment device or BMP.			
Locate storm drain inlets away from the immediate vicinity of the fueling area			
Stencil or mark storm drain inlets with "No Dumping, Drains to _____" message.			
Pave fueling stations with concrete rather than asphalt.			

<i>For official use only:</i>		
<b><i>Date of Submission:</i></b> _____	<b><i>Reviewed by:</i></b> _____	<b><i>Plan Accepted: Y / N</i></b>
<b><i>Date Received:</i></b> _____	<b><i>Reviewed on:</i></b> _____	



**Instructions:** Complete this table only if operation H-3 was checked on Page Q.2.

<b>H-3 Vehicle Washing</b>			
Description of Operation			
Requirement	Description of pollution prevention mechanism or BMP to be implemented	Site Plan Sheet Number(s)	Approved (for official use only)
Include flow-restricted hose nozzles that automatically turn off when left unattended.			
Provide a containment system for washing vehicles such that wash water does not flow into storm drain system.			
Label storm drain inlets with “No Dumping, Drains to _____” signs to deter disposal of wash water in the storm drain system.			
Design facilities with designated areas for indoor vehicle washing where no other activities are performed (e.g., fluid changes or repair services).			

<i>For official use only:</i>		
<b><i>Date of Submission:</i></b> _____	<b><i>Reviewed by:</i></b> _____	<b><i>Plan Accepted: Y / N</i></b>
<b><i>Date Received:</i></b> _____	<b><i>Reviewed on:</i></b> _____	

*Instructions: Complete this table only if operation H-4 was checked on Page Q.2.*

<b>H-4 Outdoor Materials Loading and Unloading</b>			
<b>Description of Operation</b>			
<b>Requirement</b>	<b>Description of pollution prevention mechanism or BMP to be implemented</b>	<b>Site Plan Sheet Number(s)</b>	<b>Approved (for official use only)</b>
Design liquid storage areas with impervious surfaces and secondary containment.			
Minimize stormwater run-on by covering storage areas with a permanent canopy or roof.			
Slope containment areas to a drain with a positive control (lock, valve, or plug) that leads to the sanitary sewer (if permitted) or to a holding tank.			
Provide permanent cover for building materials stored outside.			
Direct runoff away from building material storage areas.			
Install a high-level alarm on storage tanks to prevent overfilling.			
<i>For official use only:</i>			
<b><i>Date of Submission:</i></b> _____	<b><i>Reviewed by:</i></b> _____	<b><i>Plan Accepted: Y / N</i></b>	
<b><i>Date Received:</i></b> _____	<b><i>Reviewed on:</i></b> _____		

**Instructions:** Complete this table only if operation H-5 was checked on Page Q.2.

<b>H-5 Outdoor or Bulk Material Storage</b>			
<b>Description of Operation</b>	(Include methods of storage, usage, treatment, and disposal.)		
<b>Requirement</b>	<b>Description of pollution prevention mechanism or BMP to be implemented</b>	<b>Site Plan Sheet Number(s)</b>	<b>Approved (for official use only)</b>
Grade the designated loading and unloading to prevent run-on or pooling of stormwater.			
Cover the loading and unloading areas with a permanent canopy or roof.			
Install an automatic shutoff valve to interrupt flow in the event of a liquid spill.			
Install a high-level alarm on storage tanks to prevent overfilling.			
Pave the loading and unloading area with concrete rather than asphalt.			
Position roof downspouts to direct stormwater away from loading and unloading areas.			
<i>For official use only:</i>			
<b><i>Date of Submission:</i></b> _____	<b><i>Reviewed by:</i></b> _____		<b><i>Plan Accepted: Y / N</i></b>
<b><i>Date Received:</i></b> _____	<b><i>Reviewed on:</i></b> _____		

### **Q.4 Hotspot Operation Pollution Prevention Profile Sheets**

The profile sheets include the following:

H-1 Vehicle Maintenance and Repair

H-2 Vehicle Fueling

H-3 Vehicle Washing

H-4 Outdoor Materials Loading and Unloading

H-5 Outdoor or Bulk Material Storage

## H-1 Vehicle Maintenance and Repair

Vehicle maintenance and repair operations can exert a significant impact on water quality by generating toxins such as solvents, waste oil, antifreeze, and other fluids. Often, vehicles that are wrecked or awaiting repair can be a stormwater hotspot if leaking fluids are exposed to stormwater runoff (Figure Q.1). Vehicle maintenance and repair can generate oil and grease, trace metals, hydrocarbons, and other toxic organic compounds.



**Figure Q.1 Vehicle yard.**

The following summarizes a series of simple pollution prevention techniques for vehicle maintenance and repair operations that can prevent stormwater contamination. Consult the Resources section below for a more comprehensive review of pollution prevention practices for vehicle maintenance and repair operations.

- Avoid hosing down work or fueling areas.
- Clean all spills immediately using dry cleaning techniques.
- Collect used antifreeze, oil, grease, oil filters, cleaning solutions, solvents, batteries, and hydraulic and transmission fluids, and recycle with appropriate agencies.
- Conduct all vehicle and equipment repairs indoors or under a cover (if done outdoors).
- Connect outdoor vehicle storage areas to a separate stormwater collection system with an oil/grit separator that discharges to a dead holding tank, the sanitary sewer, or a stormwater treatment practice.
- Designate a specific location for outdoor maintenance activities that is designed to prevent stormwater pollution (i.e., paved, away from storm drains, and with stormwater containment measures).
- Inspect the condition of all vehicles and equipment stored outdoors frequently.

- Use tarps, ground cloths, or drip pans beneath vehicles or equipment being repaired outdoors to capture all spills and drips.
- Seal service bay concrete floors with an impervious material so cleanup can be done without using solvents. Do not wash service bays to outdoor storm drains.
- Store cracked batteries in a covered secondary containment area until they can be disposed of properly.
- Wash parts in a self-contained solvent sink rather than outdoors.

Pollution prevention practices should be applied to any facility that maintains or repairs vehicles. Examples include car dealerships, body shops, service stations, quick lubes, school bus depots, trucking companies, and fleet maintenance operations at larger industrial, institutional, municipal, or transport-related operations.

Employee training is essential to successfully implement vehicle repair pollution prevention practices. The connection between the storm drain system and local streams should be emphasized so that employees understand why any fluids need to be properly disposed of. It is also important to understand the demographics of the work force; in some communities, it may require a multilingual education program. See Table Q.1 for employee training implementation considerations.

**Table Q.1 Pollution Prevention Considerations for Vehicle Maintenance and Repair**

Consideration	Description
Primary Targets for Employee Training	Owners, fleet operation managers, service managers, maintenance supervisors, mechanics, and other employees are key targets for training.
Feasibility of Prevention Techniques	Pollution prevention techniques for vehicle repair facilities broadly apply to all regions and climates. These techniques generally rely on changes to basic operating procedures, after an initial inspection of facility operations. The inspection relies on a standard operations checklist that can be completed in a few hours.
Cost	Employee training is generally inexpensive, since training can be done using posters, pamphlets, or videos. Structural practices can vary based on what equipment is required. For instance, solvent sinks to clean parts can cost from \$1,500 to \$15,000, while spray cabinets may cost more than \$50,000. In addition, proper recycling/disposal of used or spilled fluids usually requires outside contractors that may increase costs.

**Resources**

*Auto Body Shops Pollution Prevention Guide. Peaks to Prairies Pollution Prevention Information Center.* <http://peakstoprairies.org/p2bande/autobody/abguide/index.cfm>

*California Stormwater Quality Association. 2003 California Stormwater BMP Handbook: Industrial and Commercial.* <http://www.cabmphandbooks.com/>

*City of Los Angeles Bilingual Poster of BMPs for Auto Repair Industry.* [http://www.lastormwater.org/wp-content/files\\_mf/bmp\\_auto\\_poster\\_8.5x14.pdf](http://www.lastormwater.org/wp-content/files_mf/bmp_auto_poster_8.5x14.pdf)

*City of Santa Cruz. Best Management Practices for Vehicle Service Facilities (in English and Spanish).* <http://www.cityofsantacruz.com/home/showdocument?id=6038>

*Coordinating Committee For Automotive Repair (CCAR) Source: US EPA CCAR-GreenLink®, the National Automotive Environmental Compliance Assistance Center CCAR-GreenLink® Virtual Shop* <http://www.ccar-greenlink.org/>

*Massachusetts Office of Technical Assistance (OTA). Crash Course for Compliance and Pollution Prevention Toolbox.*  
<http://www.mass.gov/eea/grants-and-tech-assistance/education-and-training/education-and-outreach/ota-publications/guidance-docs/crash-course.html>

*Model Urban Runoff Program: A How-To Guide for Developing Urban Runoff Programs for Small Municipalities.* [http://www.swrcb.ca.gov/water\\_issues/programs/stormwater/murp.shtml](http://www.swrcb.ca.gov/water_issues/programs/stormwater/murp.shtml)

*Stormwater Management Manual for Western Washington: Volume IV -- Source Control BMPs.*  
<http://www.ecy.wa.gov/biblio/9914.html>

*US EPA. Facility Regulatory Tour: Vehicle Maintenance.*  
<https://www.fedcenter.gov/assistance/facilitytour/vehicle/>

## H-2 Vehicle Fueling

Spills at vehicle fueling operations have the potential to directly contribute oil, grease, and gasoline to stormwater, and can be a significant source of lead, copper, zinc, and petroleum hydrocarbons. Delivery of pollutants to the storm drain can be sharply reduced by well-designed fueling areas and improved operational procedures. The risk of spills depends on whether the fueling area is covered and has secondary containment. The type, condition, and exposure of the fueling surface can also be important. The following describes common pollution prevention practices for fueling operations. Consult the Resources section below for a more comprehensive review of pollution prevention practices for vehicle fueling.

- Maintain an updated spill prevention and response plan on premises of all fueling facilities.
- Cover fueling stations with a canopy or roof to prevent direct contact with rainfall.
- Design fueling pads for large mobile equipment to prevent the run-on of stormwater and collect any runoff in a dead-end sump.
- Keep suitable cleanup materials on the premises to promptly clean up spills.
- Install slotted inlets along the perimeter of the “downhill” side of fueling stations to collect fluids and connect the drain to a waste tank or stormwater treatment practice. The collection system should have a shutoff valve to contain a large fuel spill event.
- Locate storm drain inlets away from the immediate vicinity of the fueling area.
- Clean fuel-dispensing areas with dry cleanup methods. Never wash down areas before dry cleanup has been done. Ensure that wash water is collected and disposed of in the sanitary sewer system or approved stormwater treatment practice.
- Pave fueling stations with concrete rather than asphalt.
- Protect above ground fuel tanks using a containment berm with an impervious floor of Portland cement. The containment berm should have enough capacity to contain 110% of the total tank volume.
- Use fuel-dispensing nozzles with automatic shutoffs, if allowed.
- Consider installing a perimeter sand filter to capture and treat any runoff produced by the station.

These practices can be applied to any facility that dispenses fuel. Examples include retail gas stations, bus depots, marinas, and fleet maintenance operations (Figure Q.2). In addition, these practices also apply to temporary above-ground fueling areas for construction and earthmoving equipment.





**Figure Q.2 Covered Retail Gas Operation Without Containment for Potential Spills.**

Employee training is essential to successfully implement vehicle fueling pollution prevention practices. See Table Q.2 for employee training implementation considerations.

**Table Q.2 Pollution Prevention Considerations for Fueling Operation Areas**

Consideration	Description
Primary Targets for Employee Training	Training efforts should be targeted to owners, operators, attendants, and petroleum wholesalers.
Feasibility of Prevention Techniques	Vehicle fueling pollution prevention practices apply to all geographic and climatic regions. The practices are relatively low-cost, except for structural measures that are installed during new construction or station remodeling.
Fueling Area Covers	Fueling areas can be covered by installing an overhanging roof or canopy. Covers prevent exposure to rainfall and are a desirable amenity for retail fueling station customers. The area of the fueling cover should exceed the area where fuel is dispensed. All downspouts draining the cover or roof should be routed to prevent discharge across the fueling area. If large equipment makes it difficult to install covers or roofs, fueling islands should be designed to prevent stormwater run-on through grading, and any runoff from the fueling area should be directed to a dead-end sump.
Surfaces	Fuel dispensing areas should be paved with concrete; the use of asphalt should be avoided, unless the surface is sealed with an impervious sealant. Concrete pads used in fuel dispensing areas should extend to the full length that the hose and nozzle assembly can be pulled, plus an additional foot.
Grading	Fuel dispensing areas should be graded with a slope that prevents ponding and is separated from the rest of the site by berms, dikes, or other grade breaks that prevent run-on of urban runoff. The recommended grade for fuel dispensing areas is 2%–4%.
Cost	Costs to implement pollution prevention practices at fueling stations will vary, with many of the costs coming upfront during the design of a new fueling facility. Once a facility has implemented, the ongoing maintenance costs should be low.

**Resources**

*Alachua County, FL Best Management Practices for Controlling Runoff from Gas Stations*  
<http://www.alachuacounty.us/Depts/EPD/Documents/WaterResources/Gas%20Stations.pdf>

*Best Management Practice Guide – Retail Gasoline Outlets.* Prepared by Retail Gasoline Outlet Work Group.  
[http://www.waterboards.ca.gov/rwqcb4/water\\_issues/programs/stormwater/municipal/los\\_angeles\\_ms4/tentative/rgo%20bmp%20guide\\_03-97\\_.pdf](http://www.waterboards.ca.gov/rwqcb4/water_issues/programs/stormwater/municipal/los_angeles_ms4/tentative/rgo%20bmp%20guide_03-97_.pdf)

*California Stormwater Quality Association. 2003 California Stormwater BMP Handbook: New Development and Redevelopment.* <http://www.cabmphandbooks.com/>

*California Stormwater Regional Control Board Retail Gasoline Outlets: New Development Design Standards For Mitigation Of Stormwater Impacts*  
[http://www.waterboards.ca.gov/rwqcb4/water\\_issues/programs/stormwater/municipal/los\\_angeles\\_ms4/tentative/rgopaper.pdf](http://www.waterboards.ca.gov/rwqcb4/water_issues/programs/stormwater/municipal/los_angeles_ms4/tentative/rgopaper.pdf)

[http://www.waterboards.ca.gov/rwqcb4/water\\_issues/programs/stormwater/municipal/los\\_angeles\\_ms4/tentative/rgopapersupplement\\_12-01\\_.pdf](http://www.waterboards.ca.gov/rwqcb4/water_issues/programs/stormwater/municipal/los_angeles_ms4/tentative/rgopapersupplement_12-01_.pdf)

*Canadian Petroleum Products Institute Best Management Practices Stormwater Runoff from Petroleum Facilities*  
<http://canadianfuels.ca/userfiles/file/CPPI%20-%20BMP%20Stormwater%20runoff%20-%20March-04.pdf>

*City of Los Angeles, CA Best Management Practices for Gas Stations*  
[http://www.lacitysan.org/watershed\\_protection/pdfs/gasstation.pdf](http://www.lacitysan.org/watershed_protection/pdfs/gasstation.pdf)

*City of Dana Point Tips for the Automotive Industry*  
<http://www.danapoint.org/Modules/ShowDocument.aspx?documentid=3309>

*Pinole County, CA Typical Stormwater Violations Observed in Auto Facilities and Recommended Best Management Practices (BMPs)*  
<http://www.ci.pinole.ca.us/publicworks/downloads/AutoStormwater.pdf>

*Stormwater Management Manual for Western Washington: Volume IV -- Source Control BMPs.*  
<http://www.ecy.wa.gov/biblio/9914.html>

### H-3 Vehicle Washing

Vehicle washing pollution prevention practices apply to many commercial, industrial, institutional, municipal, and transport-related operations. Vehicle wash water may contain sediments, phosphorus, metals, oil and grease, and other pollutants that can degrade water quality. When vehicles are washed on impervious surfaces such as parking lots or industrial areas, dirty wash water can contaminate stormwater that ends up in streams.

Improved washing practices can be used at any facility that routinely washes vehicles. Examples include commercial car washes, bus depots, car dealerships, rental car companies, trucking companies, and fleet operations. In addition, washing dump trucks and other construction equipment can be a problem. The following provides some of the pollution prevention techniques available for vehicle washing operations. Consult the Resources section below for a more comprehensive review of pollution prevention practices for vehicle washing.

- Wash vehicles at indoor car washes that recycle, treat, or convey wash water to the sanitary sewer system.
- Use biodegradable, phosphate-free, water-based soaps.
- Use flow-restricted hose nozzles that automatically turn off when left unattended.
- Wash vehicles on a permeable surface or a washpad that has a containment system.
- Prohibit discharge of wash water into the storm drain system or ground by using temporary berms, storm drain covers, drain plugs, or other containment system.
- Label storm drains with “No Dumping” signs to deter disposal of wash water in the storm drain system.
- Pressure and steam clean offsite to avoid runoff with high pollutant concentrations.
- Obtain permission from sewage treatment facilities to discharge to the sanitary sewer.

The ideal practice is to wash all vehicles at commercial car washes or indoor facilities that are specially designed for washing operations. The following offers tips for indoor car wash sites:

- Facilities should have designated areas for indoor vehicle washing where no other activities are performed (e.g., fluid changes or repair services).
- Indoor vehicle wash areas should have floor drains that receive only vehicle washing wastewater (not floor washdown or spill removal wash waters) and be connected to a holding tank with a gravity discharge pipe, to a sump that pumps to a holding tank, or to an oil/grit separator that discharges to a municipal sanitary sewer.
- The floor of indoor vehicle wash bays should be completely bermed to collect wash water.
- Aromatic and chlorinated hydrocarbon solvents should be eliminated from vehicle-washing operations.
- Vehicle-washing operations should use vehicle rinse water to create new wash water using recycling systems that filter and remove grit.

When washing operations are conducted outside, a designated wash area should have the following characteristics:

- Paved with an impervious surface, such as Portland cement concrete.
- Bermed to contain wash water.
- Sloped so that wash water is collected and discharged to the sanitary sewer system, holding tank, or dead-end sump.
- Operated by trained workers to confine washing operations to the designated wash area.

Outdoor vehicle washing facilities should use pressurized hoses without detergents to remove most dirt and grime. If detergents are used, they should be phosphate-free to reduce nutrient loading. If acids, bases, metal brighteners, or degreasing agents are used, wash water should be discharged to a treatment facility, sanitary sewer, or a sump. In addition, waters from the pressure washing of engines and vehicle undercarriages must be disposed of using the same options.

Discharge to pervious areas may be an option for washing operations that generate small amounts of relatively clean wash water (water only—no soaps, no steam cleaning). The clean wash water should be directed as sheet flow across a vegetated area to infiltrate or evaporate before it enters the storm drain system. This option should be exercised with caution, especially in environmentally sensitive areas or protected groundwater recharge areas.

The best way to avoid stormwater contamination during washing operations is to drain the wash water to the sanitary sewer system. Operations that produce high volumes of wash water should consider installing systems that connect to the sewer. Other options for large and small operations include containment units to capture the wash water prior to transport away for proper disposal (Figure Q.3). If vehicles must be washed on an impervious surface, a storm drain filter should be used to capture solid contaminants.



**Figure Q.3 Containment System Preventing Wash Water from Entering the Storm Drain.**

Employee training is essential to successfully implement vehicle washing pollution prevention practices. See Table Q.3 for employee training implementation considerations.

**Table Q.3 Pollution Prevention Considerations for Vehicle Washing Areas**

Consideration	Description
Primary Targets for Employee Training	Owners, fleet managers, and employees of operations that include car washes are the primary training target.
Feasibility of Prevention Techniques	<p>Vehicle washing practices can be applied to all regions and climates. Vehicle washing tends to occur more frequently in summer months and in drier regions of the country. Sound vehicle washing practices are not always used at many sites because operators are reluctant to change traditional cleaning methods. Additionally, the cost of specialized equipment to manage high volumes of wash water can be too expensive for small businesses.</p> <p>Improved vehicle washing practices are relatively simple to implement and are very effective at preventing stormwater contamination. Training is essential to get owners and employees to adopt these practices, and should be designed to overcome cultural and social barriers to improved washing practices.</p>
Cost	<p>The cost of using vehicle-washing practices can vary greatly and depends on the size of the operation (Table Q.4). The cost of constructing a commercial grade system connected to the sanitary sewer can exceed \$100,000. Disposal fees and frequency of washing can also influence the cost.</p> <p>Training costs can be minimized by using educational materials available from local governments, professional associations, or EPA's National Compliance Assistance Centers (<a href="http://www.assistancecenters.net/">http://www.assistancecenters.net/</a>). Temporary, portable containment systems can be shared by several companies that cannot afford specialized equipment independently.</p>

**Table Q.4 Sample Equipment Costs for Vehicle Washing Practices**

Item	Cost
Bubble Buster	\$2,000–\$2,500*
Catch basin insert	\$65*
Containment mat	\$480–\$5,840**
Storm drain cover (24-in. drain)	\$120**
Water dike/ berm (20 ft)	\$100**
Pump	\$75–\$3,000**
Wastewater storage container	\$50–\$1,000+**

Source: \*U.S. EPA, 1992 \*\*Robinson, 2003

### Resources

*Alachua County BMP for Outdoor Car Washing.*

<http://www.alachuacounty.us/Depts/EPD/WaterResources/StormwaterPollutionAndSolutions/Reducing%20Stormwater%20Pollution%20Documents/Carwash%20BMP.pdf>

*California Stormwater Quality Association. 2003 California Stormwater BMP Handbook: Industrial and Commercial.* <http://www.cabmphandbooks.com/>

*EPA FedSite Facility Regulatory Tour:*

<http://www.fedcenter.gov/assistance/facilitytour/vehicle/washing/>

*Kitsap County Sound Car Wash Program.* <http://www.kitsapgov.com/sswm/carwash.htm>.

*Robinson, C., Proprietor, "Latimat" portable wastewater containment system. Personal Communication June 2, 2003.* [http://www.chappellsupplyoftexas.com/latimat\\_systems.htm](http://www.chappellsupplyoftexas.com/latimat_systems.htm)

*Washington Department of Ecology. 1995. Vehicle and Equipment Wash Water Discharges: Best Management Practices Manual. Olympia, Washington.* <http://www.ecy.wa.gov/pubs/95056.pdf>

*U.S. Environmental Protection Agency. Pollution Prevention/Good Housekeeping for Municipal Operations.* <http://water.epa.gov/polwaste/npdes/swbmp/Pollution-Prevention-Good-Housekeeping-for-Municipal-Operators.cfm>

*U.S. EPA. 1992. Storm Water Management for Industrial Activities: Developing Pollution Prevention Plans and Best Management Practices. US EPA Office of Wastewater Management. Washington, D.C. EPA 832-R-92-006*

## H-4 Outdoor Materials Loading and Unloading

Outdoor loading and unloading normally takes place on docks or terminals at many commercial, industrial, institutional, and municipal operations. Materials spilled or leaked during this process can either be carried away in stormwater runoff or washed off when the area is cleaned. As a result, many different pollutants can be introduced into the storm drain system, including sediment, nutrients, trash, organic material, trace metals, and an assortment of other pollutants. Many simple and effective pollution prevention practices can be used at loading and unloading areas to prevent runoff contamination, as listed below. Consult the Resources section below for a more comprehensive review of pollution prevention practices for outdoor materials loading and unloading.

- Use seals, overhangs, or door skirts on docks and terminals to prevent contact with stormwater.
- Avoid loading and unloading materials in the rain.
- Close adjacent storm drains during loading and unloading operations.
- Surround the loading and unloading area with berms or grading to prevent run-on or pooling of stormwater. If possible, cover the area with a canopy or roof.
- Ensure that a trained employee is always present to handle and clean up spills.
- Inspect the integrity of all containers before loading and unloading.
- Inspect equipment such as valves, pumps, flanges, and connections regularly for leaks, and repair as needed.
- Install an automatic shutoff valve to interrupt flow in the event of a catastrophic liquid spill.
- Install a high-level alarm on storage tanks to prevent overfilling.
- Pave the loading and unloading area with concrete rather than asphalt.
- Place drip pans or other temporary containment devices at locations where leaks or spills may occur, and always use pans when making and breaking connections.
- Position roof downspouts to direct stormwater away from loading and unloading areas and into stormwater treatment facilities.
- Prepare and implement an Emergency Spill Cleanup Plan for the facility.
- Sweep loading and unloading area surfaces frequently to remove material that could otherwise be washed off by stormwater.
- Train all employees, especially fork lift operators, on basic pollution prevention practices and post signs.

While nearly every commercial, industrial, institutional, municipal, and transport-related site has a location where materials or products are shipped or received, the risk of stormwater pollution is greatest for operations that transfer high volumes of material or liquids, or unload potentially hazardous materials. Some notable examples include distribution centers, grocery stores, building supply outlets, lawn and garden centers, petroleum wholesalers, warehouses, landfills, ports, solid waste facilities, and maintenance depots (Figure P.4). Attention should also be paid

to industrial operations that process bulk materials and any operations regulated under industrial stormwater NPDES permits.



**Figure P.4 Unloading Area of Warehouse.**

Loading and unloading pollution prevention practices should be integrated into the overall stormwater pollution prevention plan for a facility. Employee training should focus on proper techniques to transfer materials, using informational signs at loading docks and material handling sites and during routine safety meetings. See Table P.5 for employee training implementation considerations.

**Table P.5 Pollution Prevention Considerations for Loading and Unloading Areas**

Consideration	Description
Primary Targets of Employee Training	Owners, site managers, facility engineers, supervisors, and employees of operations with loading and unloading facilities are the primary training target.
Feasibility of Prevention Techniques	Loading and unloading pollution prevention practices can be applied in all geographic and climatic regions, and work most effectively at preventing sediment, nutrients, toxic materials, and oil from encountering stormwater runoff or run-on. Few impediments exist to using this practice, except for the cost to retrofit existing loading and unloading areas with covers or secondary containment.
Cost	Costs to implement loading and unloading pollution prevention practices consist of one-time construction costs to retrofit new or existing loading areas; annual maintenance costs are relatively low thereafter. Exceptions include industries that elect to use air pressure or vacuum systems for loading and unloading facilities, which can also be expensive to maintain (U.S. EPA, 1992). Ongoing costs include employee training and periodic monitoring of loading and unloading activities.



**Resources**

*California Stormwater Quality Association. 2003 California Stormwater BMP Handbook: Industrial and Commercial.* <http://www.cabmphandbooks.com/>

*City of Los Angeles, CA Reference Guide For Stormwater Best Management Practices*  
[http://www.lacitysan.org/watershed\\_protection/pdfs/bmp\\_refguide.pdf](http://www.lacitysan.org/watershed_protection/pdfs/bmp_refguide.pdf)

*Stormwater Management Manual for Western Washington: Volume IV -- Source Control BMPs.*  
WA Dept. of Ecology 99-14 <http://www.ecy.wa.gov/biblio/9914.html>

*U.S. EPA. 1992. Storm Water Management for Industrial Activities: Developing Pollution Prevention Plans and Best Management Practices.* US EPA Office of Wastewater Management. Washington, D.C. EPA 832-R-92-006.

*Ventura County Flood Control District Clean Business Program Fact Sheet*  
<http://www.vcstormwater.org/index.php/clean-business-fact-sheets>

### H-5 Outdoor or Bulk Material Storage

Protecting outdoor storage areas is a simple and effective pollution prevention practice for many commercial, industrial, institutional, municipal, and transport-related operations. The underlying concept is to prevent runoff contamination by avoiding contact between outdoor materials and stormwater. Unprotected outdoor storage areas can generate a wide range of stormwater pollutants, such as sediment, nutrients, toxic materials, and oil and grease (see Figure P.5).



**Figure P.5 Mulch Stored Outdoors at a Garden Center.**

Materials can be protected by installing covers, secondary containment, and other structures to prevent accidental release. Outdoor storage areas can be protected on a temporary basis (tarps or plastic sheeting) or permanently through structural containment measures such as roofs, buildings, or concrete berms. The following summarizes pollution prevention practices available for outdoor storage areas. Consult the Resources section below for a more comprehensive review of pollution prevention practices for outdoor or bulk material storage.

- Emphasize employee education regarding storage area maintenance.
- Keep an up-to-date inventory of materials stored outdoors, and try to minimize them.
- Store liquids in designated areas on an impervious surface with secondary containment.
- Inspect outdoor storage containers regularly to ensure they are in good condition.
- Minimize stormwater run-on by enclosing storage areas or building a berm around them.
- Slope containment areas to a drain with a positive control (lock, valve, or plug) that leads to the sanitary sewer (if permitted) or to a holding tank.
- Schedule regular pumping of holding tanks containing stormwater collected from secondary containment areas.

Many businesses store materials or products outdoors. The risk of stormwater pollution is greatest for operations that store large quantities of liquids or bulk materials at sites that are connected to the storm drain system. Several notable operations include nurseries and garden centers, boat building/repair, auto recyclers/body shops, building supply outlets, landfills, ports, recycling centers, solid waste and composting facilities, highway maintenance depots, and power plants. Attention should also be paid to industrial operations that process bulk materials, which are often regulated under industrial stormwater NPDES permits.

Employee training on outdoor storage pollution prevention should focus on the activities and site areas with the potential to pollute stormwater and the proper techniques to manage material storage areas to prevent runoff contamination (see Table P.6). Training can be conducted through safety meetings and the posting of on-site informational signs. Employees should also know the on-site person who is trained in spill response.

**Table P.6 Pollution Prevention Considerations for Outdoor Storage Areas**

Consideration	Description
Primary Targets for Employee Training	Owners, site managers, facility engineers, supervisors, and employees of operations with outdoor storage facilities are the primary training target.
Feasibility of Prevention Techniques	<p>Outdoor storage protection can be widely applied in all regions and climate zones and requires routine monitoring by employees. Many operations have used covering as the major practice to handle outdoor storage protection. The strategy is to design and maintain outdoor material storage areas so that they comply with the following:</p> <ul style="list-style-type: none"> <li>▪ Reduce exposure to stormwater and prevent run-on.</li> <li>▪ Use secondary containment to capture spills.</li> <li>▪ Can be regularly inspected.</li> <li>▪ Have an adequate spill response plan and cleanup equipment.</li> </ul>
Covers	The use of impermeable covers is an effective pollution prevention practice for non-hazardous materials. Covers can be as simple as plastic sheeting or tarps, or more elaborate roofs and canopies. Site layout, available space, affordability, and compatibility with the covered material all dictate the type of cover needed for a site. In addition, the cover should be compatible with local fire and building codes and OSHA workplace safety standards. Care should be taken to ensure that the cover fully protects the storage site and is firmly anchored into place.

Consideration	Description
Secondary Containment	<p>Secondary containment is designed to contain possible spills of liquids and prevent stormwater run-on from entering outdoor storage areas. Secondary containment structures vary in design, ranging from berms and drum holding areas to specially designed solvent storage rooms (see Figure P.6).</p> <p>Secondary containment can be constructed from a variety of materials, such as concrete curbs, earthen berms, plastic tubs, or fiberglass or metal containers. The type of material used depends on the substance contained and its resistance to weathering. In general, secondary containment areas should be sized to hold 110% of the volume of the storage tank or container unless other containment sizing regulations apply (e.g., fire codes).</p> <p>If secondary containment areas are uncovered, any water that accumulates must be collected in a sanitary sewer, a stormwater treatment system, or a licensed disposal facility. Water quality monitoring may be needed to determine whether the water is contaminated and dictate the method of disposal. If the stormwater is clean, or an on-site stormwater treatment practice is used, a valve should be installed in the containment dike so that excess stormwater can be drained out of the storage area and directed either to the storm drain (if clean) or into the stormwater treatment system (if contaminated). The valve should always be kept closed except when stormwater is drained, so that any spills that occur can be effectively contained. DC Water may not allow discharges from a large containment area into the sewer system, and permission must be obtained before discharging.</p> <p>If discharges to the sanitary sewer system are prohibited, containment should be provided, such as a holding tank that is regularly pumped out.</p>
Cost	<p>Many storage protection practices are relatively inexpensive to install (Table P.7). Actual costs depend on the size of the storage area and the nature of the pollution prevention practices. Other factors include whether practices are temporary or permanent and the type of materials used for covers and containment. Employee training can be done in connection with other safety training to reduce program costs. Training costs can also be reduced by using existing educational materials from local governments, professional associations, or from EPA’s National Compliance Assistance Centers (<a href="http://www.assistancecenters.net">http://www.assistancecenters.net</a>).</p>



**Figure P.6 Secondary Containment of Storage Drums Behind a Car Repair Shop.**

**Table P.7 Sample Equipment Costs for Outdoor Storage Protection**

Storage Protection Device	Cost
Concrete Slab (6 inches)	\$3.50 to \$5.00 per ft <sup>2</sup>
Containment Pallets	\$50 to \$350 based on size and number of barrels to be stored
Storage Buildings	\$6 to \$11 per ft <sup>2</sup>
Tarps & Canopies	\$25 to \$500 depending on size of area to cover
<i>Sources: Costs were derived from a review of Ferguson et al., 1997 and numerous websites that handle proprietary spill control or hazardous material control products</i>	

**Resources**

*Alameda Countywide Clean Water Program Outdoor Storage of Liquid Materials*  
<http://alamedaca.gov/go-green/clean-water-resources>

*California Stormwater Quality Association. 2003 California Stormwater BMP Handbook: Industrial and Commercial.* <http://www.cabmphandbooks.com/>

*California Stormwater Quality Association Factsheet: Outdoor Storage of Raw Materials*  
<https://www.casqa.org/>

*EPA Office of Wastewater Management Storm Water Management Fact Sheet: Coverings*  
<http://www.epa.gov/owm/mtb/covs.pdf>

*Ferguson, T., R. Gigac, M. Stoffan, A. Ibrahim, and H. Aldrich. 1997. Rouge River National Wet Weather Demonstration Project. Wayne County, MI.*

*Rouge River National Wet Weather Demonstration Project. Wayne County, MI.*  
<http://www.rougeriver.com/proddata/catalog7ad4.html?category=overview#PI-PAPER-01.00>

*Storm Water Management Fact Sheet: Coverings. USEPA, Office of Water,*  
[http://water.epa.gov/scitech/wastetech/upload/2002\\_06\\_28\\_mtb\\_covs.pdf](http://water.epa.gov/scitech/wastetech/upload/2002_06_28_mtb_covs.pdf)

*Washtenaw County, MI Community Partners for Clean Streams Fact Sheet Series #1: Housekeeping Practices*  
[http://www.ewashtenaw.org/government/drain\\_commissioner/dc\\_webWaterQuality/dc\\_cpcs/cpcs-handbook/cpcs-series-1-housekeeping-practices.pdf](http://www.ewashtenaw.org/government/drain_commissioner/dc_webWaterQuality/dc_cpcs/cpcs-handbook/cpcs-series-1-housekeeping-practices.pdf)



# Appendix R Pollution Prevention Through Good Housekeeping

## R.1 Pollution Prevention

This appendix is meant to complement Appendix Q Stormwater Hotspots and an Erosion and Sediment Control Plan (ESCP), but not reiterate EPA's Construction General Permit requirements. These notes shall appear as stamped notes on Stormwater Management Plans (SWMPs) where land disturbance is greater than 5,000 square feet and less than 1 acre. These notes shall constitute a minimum Stormwater Pollution Prevention Plan and provide guidance on good housekeeping practices to prevent potential construction site pollutants from interacting with stormwater.

## R.2 Stormwater Management Plan (SWMP) Good Housekeeping Stamp Notes

**Fuels and Oils.** On-site refueling will be conducted in a dedicated location away from access to surface waters. Tanks fabricated with double walls do not require an additional bermed area. Install containment berms and/or secondary containments around refueling areas and storage tanks. Spills will be cleaned up immediately and contaminated soils disposed of in accordance with all federal and District of Columbia regulations. Petroleum products will be stored in clearly labeled tightly sealed containers. All vehicles on-site will be monitored for leaks and receive regular preventive maintenance activities. Any asphalt substances used on-site will be applied according to manufacturer's recommendations. Spill kits will be included with all fueling sources and maintenance activities.

**Solid Waste.** No solid materials shall be discharged to surface water. Solid materials including building materials, garbage, and paint debris shall be cleaned up daily and deposited into dumpsters, which will be periodically removed and deposited into a landfill. A cover is required for all dumpsters when the dumpster is not actively being loaded with waste materials.

**Abrasive Blasting.** Water blasting, sandblasting, and other forms of abrasive blasting on painted surfaces built prior to 1978 may only be performed if an effective containment system prevents dispersal of paint debris.

**Fertilizer.** Fertilizers will be applied only in the minimum amounts recommended by the manufacturer, worked into the soil to limit exposure to stormwater, and stored in a covered shed. Partially used bags will be transferred to a sealable bin to avoid spills.

**Paint and Other Chemicals.** All paint containers and curing compounds will be tightly sealed and stored when not required for use. Excess paint will not be discharged to the storm sewers, but will be properly disposed of according to manufacturer's recommendations. Spray guns will be cleaned on a removable tarp. Chemicals used on-site are kept in small quantities and in closed

containers undercover and kept out of direct contact with stormwater. As with fuels and oils, any inadvertent spills will be cleaned up immediately and disposed of according federal and District of Columbia regulations.

**Concrete.** Concrete trucks will not be allowed to wash out or discharge surplus concrete or drum wash on-site, except in a specially designated concrete disposal area. Form release oil for decorative stone work will be applied over a pallet covered with an absorbent material to collect excess fluid. The absorbent material will be replaced and disposed of properly when saturated.

**Water Testing.** When testing and/or cleaning water supply lines, the discharge from the tested pipe will be collected and conveyed to a completed stormwater conveyance system for ultimate discharge into a stormwater best management practice (BMP).

**Sanitary Waste.** Portable lavatories located on-site will be serviced on a regular basis by a contractor. Portable lavatories will be located in an upland area away from direct contact with surface waters. Any spills occurring during servicing will be cleaned immediately and contaminated soils disposed of in accordance with all federal and District of Columbia regulations.



# Appendix S Integrated Pest Management

## S.1 Integrated Pest Management

This appendix is in support of the District of Columbia's legislation B19-745, The Anacostia Waterfront Environmental Standards Amendment Act of 2012. This legislation requires regulated projects in the AWDZ governed by this legislation to receive a DOEE approved Integrated Pest Management Plan (see Figure S.1 for a sample plan).


Integrated Pest Management (IPM) is an approach that applies biological, cultural, mechanical, and chemical controls to manage pests at acceptable levels. The following are general guidelines to encourage a more considered use of fertilizers, herbicides, and pesticides.

## S.2 Components of an Integrated Pest Management Plan

1. **Identification.** Identify the pest and understand its life cycle. Correctly identify the pest to determine an appropriate control strategy. For assistance with pest identification, contact the Maryland Home & Garden Information Center at Maryland Cooperative Extension.
2. **When to Take Action.** Insects are an integral part of the local ecology; thus, their presence alone is not reason for taking action. First, monitor pest numbers and determine if preventative maintenance measures can be employed to remediate the situation. Take action only when alternative preventative methods are no longer feasible and when pest activity threatens the long-term health of the plant.
3. **Prevention in Design:**
  - (a) Choose the right plant for the right location.
  - (b) Assess species' suitability to site soils, moisture, wind, and sun exposure. Well-selected species require less maintenance.
  - (c) Select plant species and cultivars resistant to disease.
  - (d) Select a diverse plant palette to ensure ongoing survival of remaining plant material.
  - (e) Inspect delivered plant material at the nursery and again prior to installation. Material delivered from the nursery may carry pathogens or insects. Reject any material that is diseased.
4. **Prevention in Maintenance and Construction.** Proper cultural management practices can reduce plant stress and thus decrease their susceptibility to pests. Prior to applying pesticide or herbicides, consider your current landscape management practices. Soils are the foundation for healthy plants; it is important to provide the proper moisture, fertility, organic matter, and drainage.
  - (a) **Soil Testing.** Submit a soil sample to a soil testing laboratory for analysis. The results will determine the appropriate soil amendments to be applied.

- (b) **Fertilizers.** Organic fertilizers are derived from natural sources such as cottonseed meal, blood meal, fish emulsion, and manure. Slow-release inorganic fertilizers supply nutrients over the growing season with less nutrient loss than quick-release fertilizers. Fertilizer grade and rate should be determined by test results. Apply fertilizer only as indicated by a soil test. Do not apply fertilizer prior to a heavy rainfall event and do not apply between December and February.
  - (c) **Trees and Shrubs.** Place mulch underneath the root zone of trees and shrubs to reduce competition with turf and weeds for water and nutrients. Topdress planting beds with compost to improve soil structure, biological activity, and fertility.
  - (d) **Lawn Areas.** Increased mowing height can reduce weed germination by limiting the amount of sunlight that reaches the soil level. Topdressing with organic matter increases soil moisture and enables turf to withstand drought conditions. Regular monitoring and over-seeding of bare spots prevents weed establishment. After mowing, grass clippings should be left in place. These above-mentioned strategies will reduce symptoms of disease and weed pressure, thus decreasing herbicide and fertilizer usage.
- 5. Develop a Treatment Plan.** When pest activity exceeds acceptable levels, choose a control method appropriate to observed conditions. This may include biological, cultural, mechanical, and chemical controls.
- (a) **Biological Control.** Uses the introduction of a predator. Introduce additional natural predators where existing populations are too few to effectively control pests. Consult with your local Cooperative Extension office prior to introducing any biological controls.
  - (b) **Cultural Control.** Uses pruning and removal of diseased branches. Sanitize all tools after use. Properly amend soils and irrigate plantings as necessary.
  - (c) **Mechanical Control.** Conduct weeding by hand, tool, or heat solarization. Remove insect pests by hand or using traps.
  - (d) **Chemical Control.** Uses non-toxic, non-residual pesticide or herbicide products where necessary.
    - ◆ Narrow-spectrum contact pesticides target the pest directly and preserve beneficial predator species. Broad-spectrum pesticides also eliminate beneficial predators and thus the natural controls on pest populations. Only certified individuals can apply restricted-use pesticides.
    - ◆ Insecticidal soaps are used to penetrate the insect's outer covering, causing the cells to collapse. Horticultural oils coat and suffocate the offending insect.
    - ◆ To maximize effectiveness, apply pesticides at the appropriate point in the life cycle of the pest. Herbicide application also requires consideration of the seasonal growth pattern of the targeted weed.

### S.3 Sample Form for an Integrated Pest Management Plan



**GOVERNMENT OF THE DISTRICT OF COLUMBIA**  
**DEPARTMENT OF ENERGY AND ENVIRONMENT**  
**INSPECTION AND ENFORCEMENT DIVISION**  
**CONSTRUCTION AND MAINTENANCE BRANCH**

**Integrated Pest Management Plan**

This document/submission will serve as your integrated pest management (IPM) plan. **It must be printed and distributed to the owner of the property and to any person or company who is given responsibility for on-site pest management, landscaping, or facility maintenance (i.e. homeowners, property managers, maintenance companies).** Per the Stormwater Management Plan (SWMP) that this IPM plan supports, the owner of the property and their agents are legally required to comply with this plan.

IPM is a continuous system of controlling pests (weeds, diseases, insects, or others) where pests are identified, action thresholds are considered, all possible control options are evaluated, and selected control(s) is implemented. Control options (biological, cultural, manual, mechanical, and chemical methods) are used to prevent or remedy unacceptable pest activity or damage. Choice of control option(s) is based on effectiveness, environmental impact, site characteristics, worker/public health and safety, and economics. IPM takes advantage of all appropriate pest management options.

**PROJECT INFORMATION**

Project Name:  
Street Number:  
Street Name:  
Zip Code:  
Email Address:  
Project Developer Information (Name & Title):  
Contact:  
Company:  
Address:  
Phone:  
Fax:

**JUSTIFICATION FOR IPM PLAN**  
Ordinance Requirement  
Yes No

This development is a publically owned, privately developed property within the boundaries of the Anacostia Watershed Development Zone.

The property requires a Certificate of Occupancy and falls within the regulations of Green Area Ratio.

1

**Figure S.1 Sample form for an Integrated Pest Management Plan.**

Environmental Criteria Manual requirement  
(If site has existing or planned BMP stormwater management structures, refer to the DOEE Stormwater Management Guidebook for maintenance requirements.)

Critical Environmental Features and Buffers (List any that exist - must be shown on the site plan)

Yes	No	
<input type="radio"/>	<input type="radio"/>	Streambank
<input type="radio"/>	<input type="radio"/>	Wetland
Other		<input type="text"/>

**ANTICIPATED LANDSCAPE PESTS and SOLUTIONS**  
The Maryland Home and Garden Information Center offers regionally appropriate guidelines for preventative landscape maintenance and control of landscape pests. Refer to the following guidelines in the **Maryland Home & Garden Information Center**: <http://extension.umd.edu/hgic>.

**Check all boxes to indicate you have read the guidelines in the Maryland Home & Garden Information Center website.**

- Insects
- Invasives
- Lawns
- Plant Diagnostics
- Soils
- Trees & Shrubs
- Weeds

**ADDITIONAL IPM SUBMITTAL REQUIREMENTS – SITES WITH GREEN AREA RATIO OBLIGATION**  
Where applicable to Green Area Ratio requirements, submit the IPM plan within Green Area Ratio drawings for review by DOEE. Include the following in the submitted plans:

- Seasonal schedule of all landscape management activities for the below categories.
- A paragraph for each category describing the following: materials, methods, preventative maintenance, and pest management practices as applies to each CATEGORY listed below. To protect our water resources, you are required to start with the least toxic options before using chemical treatment applications.

CATEGORIES required for submittal in the IPM plan:

- Soil preparation
- Use of compost
- Plant replacement
- Irrigation
- Weed control
- Insect/disease control
- Control of noxious or invasive species

2

Figure S.1 (continued)

**MAINTENANCE DOCUMENTATION**

The property owner will maintain records of all Service Provider visits and pest control treatments for at least 3 years. Information regarding pest management activities will be made available to the public at the property owner’s administrative office. Requests to be notified of pesticide applications may also be made to this office. All guardians will be informed of their option to receive notification of all pesticide applications at enrollment and once annually.

Maintain the following records for all pesticide, herbicide, and fertilizer application.

- For pesticide and herbicide application:
  - Target pest and description of infestation severity
  - Prevention activities and non-chemical methods applied prior to chemical control
  - Type and quantity of pest/weed control used
  - Location of pesticide or herbicide application
  - Date of treatment application
  - Name and certification number of pesticide applicator
  - Application equipment used
  - Summary of results
- For fertilizer application:
  - Landscape type (lawn, ornamental planting beds, trees, other)
  - Location of fertilizer application within site
  - Soil report from lab with nutrient analysis and application recommendations
  - Fertilizer product description including product name and grade
  - Application rate (lb/1000 ft<sup>2</sup>)
  - Date of fertilizer application
  - Name of individual applicator and associated landscape business
  - Summary of results

**PROGRAM OUTREACH TO PROPERTY OWNER**

Developer agrees to inform the owner(s) of the property that they are required to apply less-toxic, non-chemical pest management options as described by the Maryland Home & Garden Information Center. IPM guidelines can be found at <http://extension.umd.edu/hgic>.

As the person preparing the IPM Plan, I am aware that this IPM plan is required to be filed as an exhibit in the declaration of covenants. If this is a government property or a project where covenants are not filed then this IPM plan must be an element included in the project’s SWMP (and/or Green Area Ratio) maintenance partnership agreement or memorandum of understanding. These are legal instruments requiring the use of IPM on this site.

**By checking all boxes, I certify that I have read the requirements listed here and agree to carry out an Integrated Pest Management strategy for the above-listed property**

Signature: \_\_\_\_\_

Date: \_\_\_\_\_

**Figure S.1 (continued)**



# Appendix T Proprietary Practices Approval Process

## T.1 Proprietary Practice Consideration Overview

This appendix provides details on the DOEE approval process for the use of a proprietary stormwater best management practice (BMP). If a proposed BMP is not listed in Chapter 3, “Stormwater Best Management Practices (BMPs)” of this guidebook, or deviates significantly from the specifications listed in this guidebook, an application with or prior certified approvals sufficient to demonstrate compliance with the stormwater performance standards of the District’s stormwater program must be submitted to DOEE. To differentiate between a traditional stormwater BMP, a proprietary practice, or manufactured BMP, the term Manufactured Treatment Device (MTD) will be utilized for the class of practices that require an approval from DOEE.

DOEE recognizes the value of innovative stormwater pollutant removal technologies, especially in the ultra-urban landscape of the District, where available site area is limited and often constrained by utilities and other factors. However, DOEE also acknowledges that the resources required to develop and implement a testing program for the purposes of evaluating the performance of new MTDs are beyond the current capacity of DOEE’s Regulatory Review Division. Further, DOEE recognizes that there are other state and potentially national programs being developed to provide for this testing. Therefore, until such time that DOEE develops a MTD performance testing and verification program, DOEE will accept performance testing and compliance with the New Jersey Department of Environmental Protection’s (NJDEP) Protocol for Total Suspended Solids Removal as outlined in this appendix.

## T.2 Types of Manufactured Treatment Devices

There are numerous MTDs currently available. The various configurations and stormwater treatment objectives represented by this general category of stormwater BMPs will continue to evolve and expand along with stormwater regulations and land development trends. It is not expected that a standard categorization of MTDs here can accommodate this growing industry. However, in order to best address the current regulations and foreseeable regulatory framework, the following represents the types of MTDs and performance goals that will be considered by DOEE’s stormwater program:

- **Hydrodynamic Treatment Devices.** The term “hydrodynamic” has been used to describe a family of MTDs that rely on a wet chamber or manhole to encourage gravity separation or dynamic settling of solids during flow conditions (as opposed to quiescent settling within vaults or chambers sized comparably to wet ponds). In most cases the total area of the wet chamber has been reduced through the application of dynamic settling, or vortex (as borrowed from technology applied to remove coarse solids from combined sewer overflows). The term “hydrodynamic” has therefore been loosely applied to the entire category of

practices that are designed to achieve physical settling within a small treatment area, with or without a vortex component. DOEE considers these practices to be applicable as pretreatment devices to be placed in series upstream of a primary (filtering) MTD or a retention or pollutant removal practice included in Chapter 3, “Stormwater Best Management Practices (BMPs)” of this guidebook. Pretreatment is typically an essential element of the primary BMP’s performance and designed maintenance interval and therefore no additional retention or pollutant removal credit is awarded.

- **Filtering Treatment Devices.** A broad category of MTDs utilize a filter media contained within an engineered structure. In some cases, the filter media itself may be the proprietary product, while others may also include the media container (cartridges, tubes, etc.), and/or the overall structure geometry and hydraulic components as the proprietary product. When necessary, DOEE will determine if the design, sizing, filter media, or other characteristics deviate significantly from the specifications listed in this guidebook and therefore requires an approval.
- **Retention Devices.** The current category of retention devices is limited to storage chambers, vaults, perforated pipes, and other forms of supplemental storage volume. These devices generally serve to supplement a primary retention practice such as infiltration, bioretention, etc., by providing additional storage within or adjacent to the practice. Alternatively, these devices may also supplement a pollutant removal practice by creating additional runoff storage volume. In either case, the devices are not considered treatment MTDs. Rather, these storage elements allow the primary BMP to capture and retain or treat a larger volume of runoff and are therefore considered part of the primary BMP, and not an additional treatment mechanism. Therefore, no additional pollutant removal is credited.

### **T.3 Proprietary Practice Approval Process – Background**

DOEE has reviewed different testing protocols and state sponsored MTD performance verification programs. In general, the evaluation and approval of MTD performance has traditionally been based on a combination of field monitoring and a rigorous review of the resulting data. While the consensus is that there is no substitute for field monitoring through the seasonal variations in rainfall, pollutant loading, temperature, and other factors to evaluate the performance of a stormwater BMP, there is anecdotal evidence that these studies can take a long time, be very expensive, and in some cases, be inconclusive.

The process and experience in New Jersey was derived from a multi-state testing protocol and reciprocity agreement: The Technology Acceptance Reciprocity Partnership (TARP, 2003). TARP refers to a testing protocol that outlines the standard methods and procedures to be employed when testing a stormwater MTD. The concept was based on the belief that if a manufacturer followed the TARP protocol to test the MTD, then the data would be acceptable to all the partner states. The New Jersey Department of Environmental Protection (NJDEP), in partnership with the New Jersey Corporation for Advanced Technology (NJCAT), is a TARP member state that has developed a formal evaluation and acceptance process for MTDs. Unfortunately, the “reciprocity” element of the process did not evolve primarily due to the different partner states having established different treatment objectives and performance goals. The New Jersey program established TSS as the treatment objective, while other states included nutrients or other parameters in addition to TSS.



The MTD performance certification program in New Jersey, implemented by NJDEP and NJCAT, provides a continuous evaluation of the effectiveness of the testing and verification protocol and, in an effort to establish a more reliable and consistent process, are currently transitioning to a prescriptive laboratory testing protocol. The laboratory testing of filter products may be supplemented by optional field testing to demonstrate system longevity and corresponding expected maintenance intervals.

The new protocol, entitled “New Jersey Department of Environmental Protection Process for Approval of Use for Manufactured Treatment Devices January 25, 2013” (NJDEP, 2013a), requires that MTD’s obtain Verification through NJCAT. The NJCAT Verification process, entitled “Procedure for Obtaining Verification of a Stormwater Manufactured Treatment Device from New Jersey Corporation for Advanced Technology January 25, 2013” (NJCAT, 2013), and the NJDEP protocol can be found on NJDEP’s website, <http://www.njstormwater.org/treatment.html>.

The new protocol includes a formal transition process that recognizes existing MTD certification and allows sufficient time for recertification under the new protocol. In addition, the new NJ protocol remains consistent with the DOEE stormwater program’s treatment objectives (TSS) and performance goals (80% reduction). To allow for the use of effective MTDs in the District immediately and include an opportunity to transition to a more reliable and consistent testing protocol, DOEE will accept the existing NJDEP certifications, and implement the same expiration schedule of those existing certifications and accompanying verification/certification renewal as required by NJDEP’s new protocol. DOEE will apply the District’s SWRv treatment requirements (1.2-inch rainfall, or when overtreating, up to 1.7-inch rainfall) to the specific MTD unit sizing formula as verified and certified by NJCAT and NJDEP, respectively.

#### **T.4 MTD Current Approval Status**

DOEE will accept MTDs for use in the District that have a current NJDEP verification/certification as conditioned upon those items referenced in Transition for Manufactured Treatment Devices dated July 15, 2011 (NJDEP, 2011) as follows:

- All MTDs that have a MTD Laboratory Test Certification for 80% TSS removal will be approved for use by DOEE until the NJDEP published certification expiration date (determined in conjunction with NJDEP’s January 25, 2013 adoption of the new testing protocols; NJDEP, 2013b);
- All MTD’s that have a MTD Laboratory Test Certification for 50% TSS removal will be approved for use by DOEE for pretreatment upstream of MTDs and, on a case by case basis, upstream of applicable practices listed in Chapter 3, “Stormwater Best Management Practices (BMPs)” until the NJDEP published certification expiration date (determined in conjunction with NJDEP’s January 25, 2013 adoption of the new testing protocols; NJDEP, 2013c);
- All MTDs that have a MTD Field Test Certification for 80% TSS removal will be approved for use by DOEE until the NJDEP published certification expiration date (determined in conjunction with NJDEP’s January 25, 2013 adoption of the new testing protocols; NJDEP, 2013b).

All manufacturers seeking acceptance for use in the District based on certification by NJDEP must submit evidence of NJDEP Verification/Certification (Certification Letter) and documentation representing how the MTD design and sizing is affected by the application of the District's stormwater performance standards as detailed in Chapter 2, "Minimum Control Requirements" and as compared to that of the NJDEP. The application of a specific MTD sizing criteria or model on a given development site must be rated for a Treatment Flow Rate (as defined by the 2013 protocol) greater than or equal to the District's Stormwater Retention Volume (SWRv) design storm peak flow rate. Refer to Appendix I - - Acceptable Hydrologic Methods and Models for guidance on the computational methodology for computing the District's SWRv design peak flow rate. Developers and consultants may review available products that have been certified by the NJDEP and select the one most appropriate for their site. For most recent MTD approvals consult NJDEP website <http://www.njstormwater.org/treatment.html>.

## **T.5 MTD Approval Status Renewal**

Prior to the expiration of the NJDEP verification/certification, as noted in Section S.4, all MTDs that wish to continue to be accepted for water quality treatment in the District shall formally request acceptance by DOEE and submit evidence of approval through NJDEP's 2013 MTD Laboratory Test Certification/Verification process.

## **T.6 MTD Application Fees**

Submission of evidence of verification/certification through NJDEP's MTD Certification Program does not require a review fee. However, any requests for acceptance of an MTD for other treatment parameters, including but not limited to pathogens, metals, oil and grease, or runoff volume may be subject to alternate submittal requirements and a review fee commensurate with the services required for reviewing and approving the MTD.

## **T.7 References**

MDE. 2011. Facts About Maryland's Stormwater Program & Proprietary Practices. Maryland Department of the Environment.

The National Environmental Laboratory Accreditation Conference (NELAC) Institute (TNI)  
Available at: <http://www.nelac-institute.org/>

New Jersey Corporation for Advanced Technology (NJCAT) Technology Verification Program and Testing Protocols available at: <http://www.njcat.org/>

NJCAT 2013. Procedure for Obtaining Verification of a Stormwater Manufactured Treatment Device from New Jersey Corporation for Advanced Technology January 25, 2013. Available at: <http://www.njstormwater.org/pdf/njcat-mtd-process-1-25-13.pdf>

New Jersey Department of Environmental Protection (NJDEP) 2011 Transition for Manufactured Treatment Devices, July 15, 2011. Available at: <http://www.njstormwater.org/pdf/mtd-certification-process-7-13.pdf>

NJDEP 2013a. Process for Approval of Use for Manufactured Treatment Devices January 25, 2013 Available at: <http://www.njstormwater.org/pdf/njdep-mtd-process-1-25-13.pdf>

NJDEP 2013b. Laboratory Protocol to Assess Total Suspended Solids Removal by a Filtration Manufactured Treatment Device January 25, 2013. Available at: <http://www.njstormwater.org/pdf/filter-protocol-1-25-13.pdf>

NJDEP 2013c. Laboratory Protocol to Assess Total Suspended Solids Removal by a Hydrodynamic Sedimentation Manufactured Treatment Device January 25, 2013. Available at: <http://www.njstormwater.org/pdf/hds-protocol-1-25-13.pdf>

TARP. 2003. Stormwater Best Management Practice Demonstrations (TARP Tier II Protocols). The Technology Acceptance Reciprocity Partnership. Available at: <http://www.mass.gov/eea/docs/dep/water/laws/i-thru-z/swprotoc.pdf>

U.S. EPA. 2002. Guidance for Quality Assurance Project Plans. United States Environmental Protection Agency. EPA QA/G-5. Available at: <https://www.epa.gov/quality/guidance-quality-assurance-project-plans-epa-qag-5>

U.S. EPA. 2006. Data Quality Assessment: Statistical Methods for Practitioners. United States Environmental Protection Agency. EPA QA/G-9S. Available at: <https://www.epa.gov/quality/guidance-data-quality-assessment>



# Appendix U    Underground Sand Filter Design Example

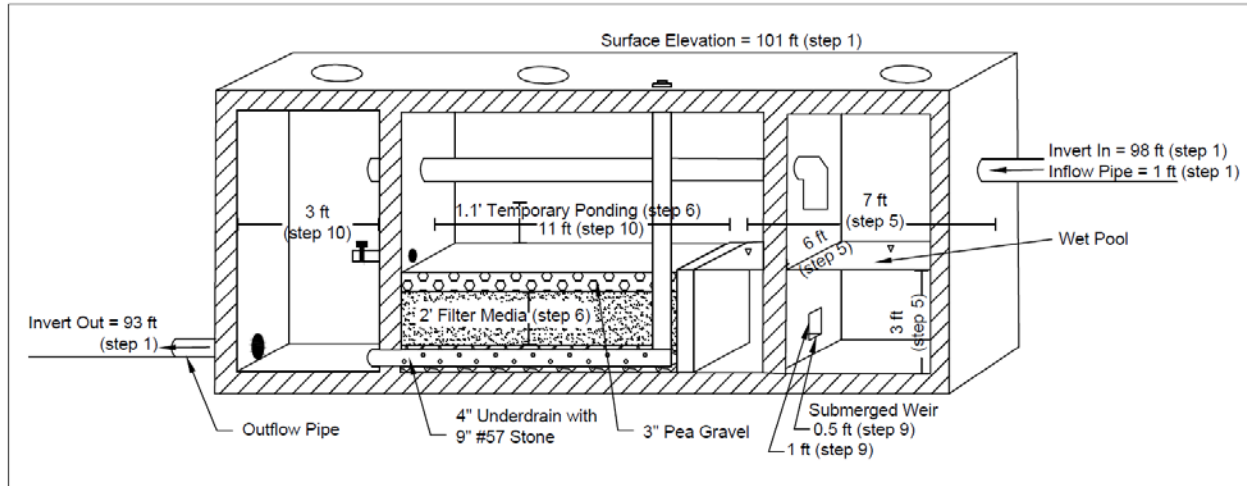
Design of underground sand filters requires proper application of a number of equations to ensure the resulting stormwater best management practice (BMP) provides adequate treatment for the design storm. This appendix illustrates the step-by-step process for designing a three-chamber underground sand filter (see Figure T.1 for sand filter schematic).

## Data Required

- Storm frequency = 15 years
- Time of concentration =  $T_c = 6$  minutes
- From District rainfall intensity - duration - frequency curve:
  - ◆ Intensity,  $i = 7.56$  inches per hour

## Assumptions

- The site is a parking lot with area,  $A = 10,000 \text{ ft}^2$ .
- The sand filter will outfall to a storm sewer.
- The distance is 50 feet from the sand filter's invert-out to the storm sewer pipe connection.
- The invert of the city storm sewer = 92 feet at the proposed connection point (note: allow a 2% slope in the pipe connecting the invert-out of the sand filter to the city storm sewer invert).
- The contributing drainage area (CDA) is 100% impervious.
- One half of the SWRV (based on a 1.2-inch storm) must be treated by the sand filter.



**Figure U.1 Sand filter schematic with steps shown.**

The following steps show how to calculate the sand filter dimensions.

**Step 1:** Determine Design Invert Elevations

Determine the final surface elevation, invert in, invert out, and bottom invert elevation of the structure.

- Invert in = 98 feet
- Invert out = 93 feet or higher (based on 2% slope for 50 feet to city storm sewer connection)

Actual head difference available within the filter between invert-in and invert-out is

$$98 \text{ ft} - 93 \text{ ft} = 5 \text{ ft}$$

- Assume inflow pipe diameter = 1 foot
- Assume over the crown pipe cover = 2 feet
- Final surface elevation above sand filter = 98 ft + 2 ft + 1 ft = 101 ft
- Minimum depth of filter layer (Section 3.7.4):  $df\text{-min} = 1 \text{ foot}$

**Step 2:** Peak Discharge Calculation for Bypass Flow

The District uses the 15-year storm (with  $T_c = 6$  minutes) for post-development runoff.

Using the Rational Method:

$$Q_{p15} = C \times I \times A$$

where:

$Q_{p15}$	=	bypass peak flow (cfs)
$C$	=	runoff coefficient = 1.0
$I$	=	rainfall intensity = 7.56 in./hr
$A$	=	drainage area = 0.23 acres
$T_c$	=	time of concentration (used in selecting rainfall intensity) = 6 min

$$Q_{p15} = 1.0 \times 7.56 \frac{\text{in}}{\text{hr}} \times 0.23 \text{ ac} = 1.74 \text{ cfs}$$

**Step 3:** Determine Design Volume

The Stormwater Retention Volume (SWR<sub>v</sub>) is determined by Equation 2.1:

**Equation 2.1 Stormwater Retention Volume**

$$SWR_v = \frac{P \times [(Rv_I \times I) + (Rv_C \times C) + (Rv_N \times N)] \times 7.48}{12}$$

where:

$SWR_v$	=	volume required to be retained (gallons)
$P$	=	selection of District rainfall event varies based on regulatory trigger: <ul style="list-style-type: none"> <li>• 90th percentile (1.2 inches) for major land-disturbing activity,</li> <li>• 85th percentile (1.0 inch) for major substantial improvement activity in the AWDZ and governed by the Anacostia Waterfront Environmental Standards Amendment Act of 2012,</li> <li>• 80th percentile (0.8 inch) for other major substantial improvement activities</li> </ul>
$Rv_I$	=	runoff coefficient for impervious cover (0.95)
$I$	=	impervious cover surface area (ft <sup>2</sup> )
$Rv_C$	=	runoff coefficient for compacted cover (0.25)
$C$	=	compacted cover surface area (ft <sup>2</sup> )
$Rv_N$	=	runoff coefficient for natural cover (0.00)
$N$	=	natural cover surface area (ft <sup>2</sup> )
7.48	=	conversion factor, converting cubic feet to gallons
12	=	conversion factor, converting inches to feet

$$SWR_v = \frac{1.2 \times [(0.95 \times 10,000) + (0.25 \times 0) + (0.00 \times 0)] \times 7.48}{12} = 7,106 \text{ gallons (950 cubic feet)}$$

In this example, the sand filter must treat half the SWR<sub>v</sub>, so the design volume is 3,553 gallons, or 475 cubic feet.

**Step 4:** Determine the Required Ponding Volume

Use the following equation:

**Equation 3.9 Required Ponding Volume for Filtering Practices**

$$V_{ponding} = 0.50 \times DesignVolume$$

where:

$$\begin{aligned} V_{ponding} &= \text{storage volume required prior to filtration (ft}^3\text{)} \\ DesignVolume &= \text{design storm volume (ft}^3\text{)} \end{aligned}$$

$$V_{ponding} = 0.50 \times 475 \text{ ft}^3 = 238 \text{ ft}^3$$

As shown in Equation 3.9, the total ponding volume must be at least 50% of the design volume. The ponding volume consists of two components:

- Pretreatment volume, which must be at least 25% of the design volume (at least 50% of the ponding volume)
- Temporary ponding volume above the pretreatment level in the first chamber and above the filter media in the second chamber

The pretreatment volume must be at least 25% of the **design volume**, so in this example, at least 119 cubic feet must be captured in the first chamber for pretreatment. The remaining ponding volume should be provided as temporary ponding above the pretreatment level in the first chamber and above the filter media in the second chamber.

**Step 5:** Determine the First Chamber Dimensions

This step will be iterative with Step 6 below, as the depth of the first chamber will be equal to the filter media depth ( $df$ ) selected in Step 6.

First Chamber Pretreatment Volume:

$$V_1 = L_1 \times W \times (d_f + 1)$$

where:

$$\begin{aligned} V_1 &= \text{permanent pretreatment volume of first chamber} = 119 \text{ ft}^3 \\ L_1 &= \text{length of first chamber (ft)} \\ W &= \text{width of chamber (ft), use 6 feet} \\ d_f + 1 &= \text{depth of permanent pretreatment, use 2 feet for } d_f \text{ from Step 6 plus} \\ &\quad \text{1 foot for underdrain and pea gravel depths} \end{aligned}$$



therefore:

$$L_1 = \frac{V_1}{W \times (d_f + 1)} = \frac{119 \text{ ft}^3}{6 \text{ ft} \times (2 \text{ ft} + 1 \text{ ft})} = 6.61 \text{ ft}$$

Use:  $L_1 = 7 \text{ ft}$

With  $L_1$  equal to 7 feet, the permanent pretreatment volume is 126 cubic feet. This means that at least 112 cubic feet must be provided in temporary ponding above the first and second chamber.

**Step 6:** Determine Sand Filter Area ( $SA_{filter}$ )

Solving Equation 3.8 below will require an iterative solution to determine the best combination of height of water ( $hf$ ), filter depth ( $df$ ) and area of the filter  $SA_{filter}$  that lead to the required ponding volume.

**Equation 3.8 Minimum Filter Surface Area for Filtering Practices**

$$SA_{filter} = \frac{DesignVolume \times d_f}{k \times (h_{avg} + d_f) \times t_d}$$

where:

- $SA_{filter}$  = area of the filter surface (ft<sup>2</sup>)
- $DesignVolume$  = design storm volume, typically the  $SWR_v$  (ft<sup>3</sup>)
- $d_f$  = filter media depth (thickness) (ft), with a minimum of 1 ft
- $k$  = coefficient of permeability (ft/day) (3.5 ft/day for partially clogged sand)
- $h_f$  = height of water above the filter bed (ft), with a maximum of 5 ft
- $h_{avg}$  = average height of water above the filter bed (ft), one half of the filter height ( $hf$ )
- $t_d$  = allowable drawdown time (1.67 days)

With a filter depth of 2 feet and a height of water of 1.1 feet:

$$SA_{filter} = \frac{475 \text{ ft}^3 \times 2 \text{ ft}}{3.5 \frac{\text{ft}}{\text{day}} \times (0.55 \text{ ft} + 2 \text{ ft}) \times 1.67 \text{ days}} = 64 \text{ ft}^2$$

A surface area of 64 square feet will yield 70 cubic feet of temporary ponding volume above the filter and 46 cubic feet of temporary ponding volume above the 6-foot by 7-foot first chamber, for a total of 116 cubic feet—enough to meet the 112-cubic-foot temporary ponding requirement.

**Step 7:** Check Design Inverts

$$D = h_f + d_f + 1 \text{ ft}$$

where:

- $D$  = depth of filter chamber (from bottom of filter to bypass pipe outlet invert) (ft)
- $h_f$  = height of water above filter bed, which vertical distance between top of filter layer and bypass pipe outlet invert = 1 foot
- $d_f$  = depth of filter layer (ft) = 2 feet
- 1 ft = additional depth for underdrain and pea gravel layers

Note:  $D$  must be equal to or smaller than the difference between the invert in and invert out (5 feet).

$$D = 1.1 \text{ ft} + 2 \text{ ft} + 1 \text{ ft} = 4.1 \text{ ft}$$

The result of 4.1 feet is less than 5 feet, which is good.

**Step 8:** Determine Size of Bypass Pipe

Determine the capacity of the bypass pipe:

$$D = \left[ \frac{2.16 \times n \times Q_{p15}}{\sqrt{S}} \right]^{0.375}$$

where:

- $D$  = estimated bypass pipe diameter (ft)
- $n$  = Manning's roughness coefficient = 0.011
- $Q_{p15}$  = bypass peak flow (cfs) = 1.74 cfs
- $S$  = pipe slope = assume 0.5% = 0.005

$$D = \left[ \frac{2.16 \times 0.011 \times 1.74}{\sqrt{0.005}} \right]^{0.375} = 0.82 \text{ ft}$$

Use:  $D = 1 \text{ ft}$  (12 in.)

**Step 9:** Determine Submerged Weir Opening in First Chamber

Since the weir opening in the first chamber is submerged, the orifice equation is used to calculate the dimensions of the weir opening:

$$Q_{p15} = C \times A_{wl} \times \sqrt{2gh_{max}}$$

therefore:

$$A_{wl} = \frac{Q_{p15}}{C \times \sqrt{2gh_{max}}}$$

where:

$A_{wl}$	= area of weir opening in first chamber (ft <sup>2</sup> ) = $h_{wl} \times l_{wl}$
$h_{wl}$	= weir height, assume 1 foot
$l_{wl}$	= weir length (ft)
$Q_{p15}$	= bypass peak flow (cfs) = 1.74 cfs
$C$	= 0.6
$g$	= gravitational acceleration (32.2 ft/s <sup>2</sup> )
$h_{max}$	= hydraulic head above the center line of weir (ft)
	= [(invert in - invert out) - ( $h_{wl}/2$ )]
	= [(98 ft - 95 ft) - 0.5 ft] = 2.5 ft

$$A_{wl} = 0.23 \text{ ft}^2 = h_{wl} \times l_{wl}$$

$$l_{wl} = \frac{A_{wl}}{h_{wl}} = \frac{0.23 \text{ ft}^2}{1 \text{ ft}} = 0.23 \text{ ft}$$

The minimum requirement is 0.23 ft.

Note: Assume 50% of the weir opening is clogged; therefore, use the following:

$$l_{wl} = 2 \times \left( \frac{A_{wl}}{h_{wl}} \right) = 2 \times \left( \frac{0.23 \text{ ft}^2}{1 \text{ ft}} \right) = 0.46 \text{ ft}$$

Use:  $l_{wl} = 0.5 \text{ ft}$

**Step 10:** Structure Dimensions (Internal Only)

Second Chamber:

$$A_f = L_2 \times W$$

where:

$A_f$	= surface area of filter layer (second chamber) = 64 ft <sup>2</sup>
$L_2$	= length of filter layer (second chamber) (ft)
$W$	= width of chamber, use 6 feet

$$L_2 = \frac{A_f}{W} = \frac{64 \text{ ft}^2}{6 \text{ ft}} = 10.7 \text{ ft}$$

Use:  $L_2 = 11 \text{ ft}$

First Chamber determined in Step 5:

$$\begin{aligned} L_1 &= 7 \text{ ft} \\ W &= 6 \text{ ft} \end{aligned}$$

Third Chamber:

Select  $L_3$ , length of third chamber = 3 ft

therefore:

$$\text{Length of structure, } L = L_1 + L_2 + L_3 = 7 \text{ ft} + 11 \text{ ft} + 3 \text{ ft} = 21 \text{ ft}$$

Total inner height inside sand filter:

$Dt$  = depth of filter chamber (Step 7) + inflow pipe diameter + free board

$$Dt = 5 \text{ ft} + 1 \text{ ft} + 2 \text{ ft} = 8 \text{ ft}$$

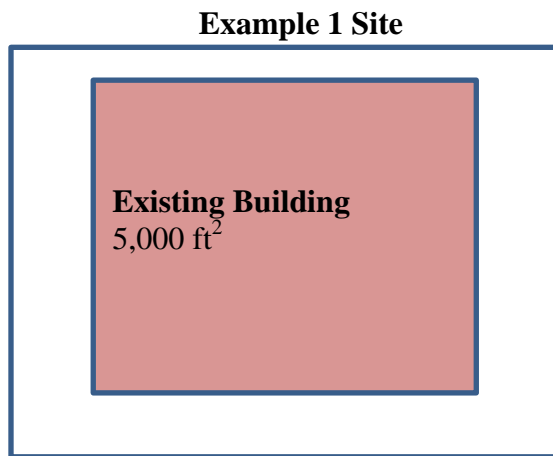
# Appendix V Examples of Regulated Activities

The following 15 examples help to clarify how the stormwater requirements apply in a variety of situations involving building renovations or additions and accompanying land disturbances, if any. The examples assume that a project is not located in the AWDZ. While many situations are discussed in these examples, this list is not intended to be exhaustive. Site owners are strongly encouraged to reach out to DOEE to help determine whether their project triggers stormwater management requirements. Diagrams are not to scale.

## **Example 1: Major Substantial Improvement Activity - Building Renovation**

An existing building with a footprint of 5,000 square feet is being renovated. The assessed value of the property is \$1,500,000. Renovation costs are estimated to be \$750,000. No additional land disturbing activity is planned.

Because the building footprint is 5,000 square feet and the renovation cost is at least 50% of its assessed value, this entire project is considered a major substantial improvement activity. A stormwater management plan is required. The required SWRv rainfall depth for the project is 0.8 inches.

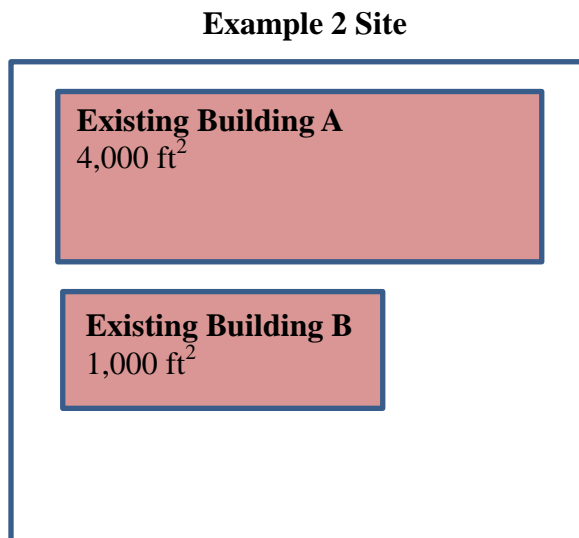


**Building Footprint** = 5,000 ft<sup>2</sup>  
**Assessed Property Value** = \$1,500,000  
**Renovation Cost** = \$750,000  
**Percent of Property Value** = 50%  
**Activity Type** = Major Substantial Improvement  
**SWRv Rainfall Depth** = 0.8 inch

**Example 2: Major Substantial Improvement Activity - Two Building Renovations on One Site**

Two existing buildings on one project site are being renovated. Building A has a footprint of 4,000 square feet; Building B has a footprint of 1,000 square feet. Building A's assessed property value is \$750,000; Building B's assessed property value is \$300,000. The estimated cost to renovate is \$500,000 for Building A and is \$175,000 for Building B. There is no additional land disturbing activity.

Both buildings are part of one project. The combined footprint of both buildings is 5,000 square feet. Additionally, the cost of the renovations for each building is equal to or greater than 50% of that building's assessed value. Therefore, the entire project constitutes a major substantial improvement activity. A stormwater management plan is required. The required SWRv rainfall depth for the project is 0.8 inch.



**Building A Footprint** = 4,000 ft<sup>2</sup>  
**Assessed Property Value A** = \$750,000  
**Renovation Cost A** = \$500,000  
**Percent of Property Value A** = 67%

**Building B Footprint** = 1,000 ft<sup>2</sup>  
**Assessed Property Value B** = \$300,000  
**Renovation Cost B** = \$175,000  
**Percent of Property Value B** = 50%

**Activity Type** = Major Substantial Improvement

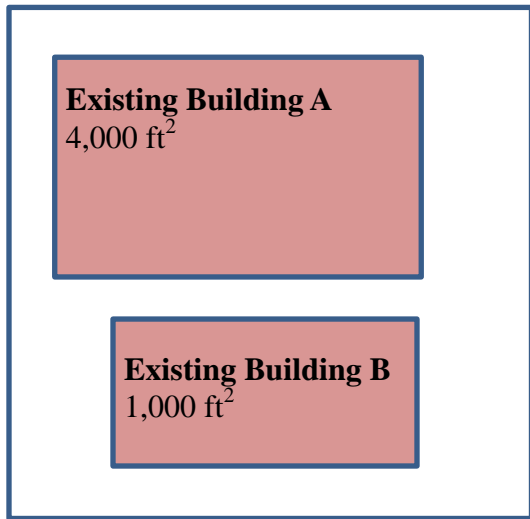
**SWRv Rainfall Depth for Project** = 0.8 inch

**Example 3: No Stormwater Regulated Activity - Two Building Renovations on One Site**

Two existing buildings on one project site are being renovated. Building A has a footprint of 4,000 square feet; Building B has a footprint of 1,000 square feet. Building A’s assessed property value is \$800,000; Building B’s assessed property value is \$400,000. The estimated cost of renovation for Building A is \$300,000 and is \$250,000 for Building B. No additional land disturbing activity is planned.

The cost of renovations for Building A is less than 50% of the building’s assessed value, while the cost of renovations for Building B is greater than 50% of the building’s value. Although the combined footprint of the two buildings is 5,000 square feet or greater, because the construction cost of one of the buildings is less than 50% of its pre-project assessed value, the project is not considered a major substantial improvement activity. A stormwater management plan is not required.

**Example 3 Site**



**Building A Footprint**= 4,000 ft<sup>2</sup>  
**Assessed Property Value A**=\$800,000  
**Renovation Cost A**= \$300,000  
**Percent of Property Value A** = 38%

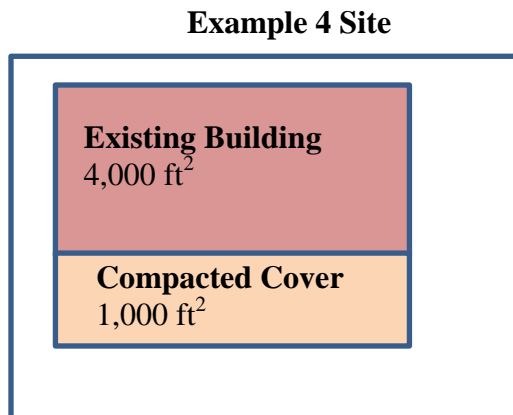
**Building B Footprint**= 1,000 ft<sup>2</sup>  
**Assessed Property Value B**=\$400,000  
**Renovation Cost B**= \$250,000  
**Percent of Property Value B** = 63%

**Activity Type** = N/A  
**SWRv Rainfall Depth for Project** = N/A

**Example 4: Major Substantial Improvement Activity – Building Renovation and Adjacent Land Disturbance.**

A building has a footprint of 4,000 square feet and an assessed value of \$800,000. The building is being renovated with an estimated cost of \$400,000. In addition, 1,000 square feet of adjacent land is being disturbed.

Since the total project footprint is equal to 5,000 square feet and the post-project impervious area is at least 2,500 square feet, the entire project, including adjacent land disturbance, constitutes a major substantial improvement activity and is regulated at the 0.8-inch standard. A stormwater management plan is required.



**Building Footprint** = 4,000 ft<sup>2</sup>  
**Assessed Property Value** = \$800,000  
**Renovation Cost** = \$400,000  
**Percent of Property Value** = 50%

**Land Disturbance Area** = 1,000 ft<sup>2</sup>  
**Total Compacted Cover Area** = 1,000 ft<sup>2</sup>

**Total Project Footprint** = 5,000 ft<sup>2</sup>  
**Post-Project Impervious cover** = 4,000 ft<sup>2</sup> > 2,500 ft<sup>2</sup>  
**Activity Type** = Major Substantial Improvement  
**SWRv Rainfall Depth for Project** = 0.8 inch

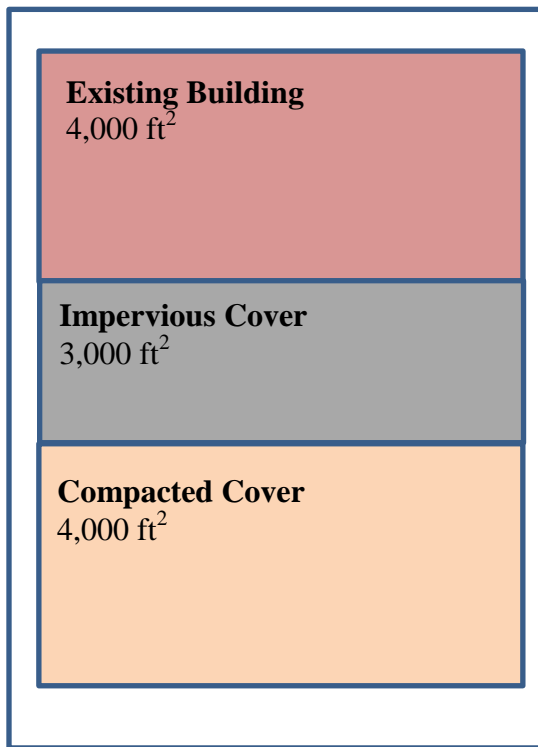


**Example 5: Major Substantial Improvement and Major Land Disturbing Activities - Building Renovation and Land Disturbance**

A building with a footprint of 4,000 square feet and an assessed value of \$800,000 is being renovated at a cost of \$400,000. In addition, 7,000 square feet of adjacent land is being disturbed that will include 3,000 square feet of impervious cover.

A stormwater management plan is required. The building renovation is considered a major substantial improvement. The renovation is part of a total project footprint that is at least 5,000 square feet; at least 2,500 square feet of the post-project land cover is impervious; and the cost of renovation is equal to or greater than 50% of its assessed value. The land disturbance is at least 5,000 square feet and includes at least 2,500 square feet of post-project impervious land cover. Therefore, the land disturbance is regulated as a major land-disturbing activity.

**Example 5 Site**



**Building Footprint** = 4,000 ft<sup>2</sup>

**Assessed Property Value** = \$800,000

**Renovation Cost** = \$400,000

**Percent of Property Value** = 50%

**Land Disturbance Area** = 7,000 ft<sup>2</sup>

**Total Compacted Cover** = 4,000 ft<sup>2</sup>

**Total Impervious Cover** = 3,000 ft<sup>2</sup>

**Total Project Footprint** = 11,000 ft<sup>2</sup>

**Activity Type for Building** =

Major Substantial Improvement

**Activity Type for Land Disturbance** =

Major Land Disturbing

**SWRv Rainfall Depth for Building** = 0.8 inch

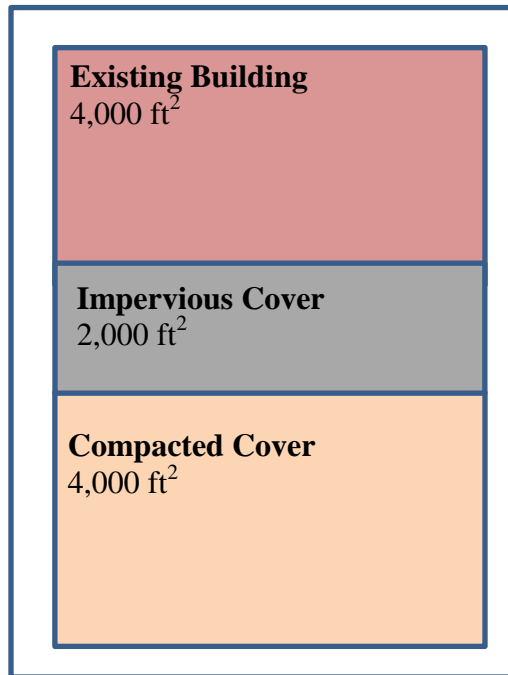
**SWRv Rainfall Depth for Land Disturbance** = 1.2 inches

**Example 6: Major Substantial Improvement - Building Renovation and Land Disturbance**

A building with a footprint of 4,000 square feet and an assessed value of \$800,000 is being renovated at a cost of \$400,000. In addition, 6,000 square feet of adjacent land is being disturbed that will include 2,000 square feet of impervious cover.

A stormwater management plan is required. The building renovation is considered a major substantial improvement activity. The total project footprint is at least 5,000 square feet; the post-project impervious area is at least 2,500 square feet; and the cost of the renovations is at least 50% of the building’s assessed value. While the land disturbance is greater than 5,000 square feet, it does not include at least 2,500 square feet of post-project impervious land cover (the existing building footprint is excluded from this total). Therefore, this project does not include a major land-disturbing activity. Instead, the land disturbance is considered part of the major substantial improvement activity.

**Example 6 Site**



**Building Footprint**= 4,000 ft<sup>2</sup>  
**Assessed Property Value** = \$800,000  
**Renovation Cost** = \$400,000  
**Percent of Property Value** = 50%

**Land Disturbance Area**= 6,000 ft<sup>2</sup>  
**Total Compacted Cover** = 4,000 ft<sup>2</sup>  
**Total Impervious Cover** = 2,000 ft<sup>2</sup>

**Total Project Footprint** = 10,000 ft<sup>2</sup>

**Activity Type for Total Project** =  
 Major Substantial Improvement

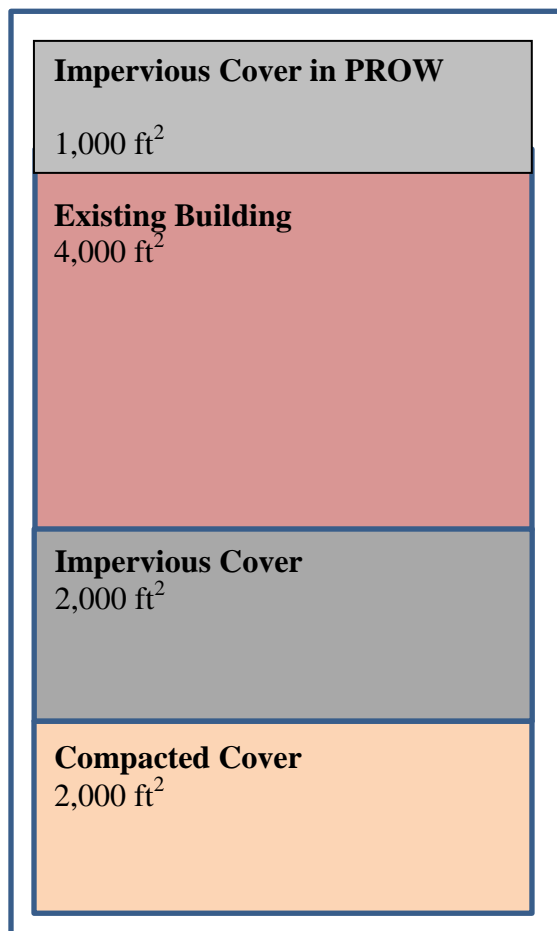
**SWRv Rainfall Depth for Building and Land Disturbance** = 0.8 inch

**Example 7: Major Substantial Improvement and Major Land Disturbance - Building Renovation, Land Disturbance, and Land Disturbance in the Existing PROW**

A building with a footprint of 4,000 square feet with an assessed value of \$700,000 is being renovated at a cost of \$350,000. In addition, 5,000 square feet of adjacent land is being disturbed (including both the private property and the existing PROW) that will include a total of 3,000 square feet of impervious cover post-project, 1,000 square feet of which is in the PROW.

A stormwater management plan is required. The building renovation is considered a major substantial improvement activity. The cost of the renovations is at least 50% of the building's assessed value and is part of a total project footprint of at least 5,000 square feet with at least 2,500 square feet of post-project impervious area. The land disturbance is regulated as a major land-disturbing activity. There is least 5,000 square feet of land disturbance, and includes at least 2,500 square feet of post-project impervious land cover. Land disturbance in the existing PROW that is associated with either a major substantial improvement activity or a major land-disturbing activity is always required to meet the 1.2-inch standard to the MEP.

**Example 7 Site**



**Building Footprint** = 4,000 ft<sup>2</sup>  
**Assessed Property Value** = \$700,000  
**Renovation Cost** = \$350,000  
**Percent of Property Value** = 50%

**Land Disturbance Area** = 5,000 ft<sup>2</sup>  
**Total Compacted Cover** = 2,000 ft<sup>2</sup>  
**Total Impervious Cover** = 3,000 ft<sup>2</sup>  
 (Includes PROW = 1,000 ft<sup>2</sup>)

**Total Project Footprint** = 9,000 ft<sup>2</sup>

**Activity Type for Building** =  
 Major Substantial Improvement

**Activity Type for Land Disturbance** =  
 Major Land Disturbing

**SWRv Rainfall Depth for Building** = 0.8 inch

**SWRv Rainfall Depth for Parcel Land Disturbance** = 1.2 inches

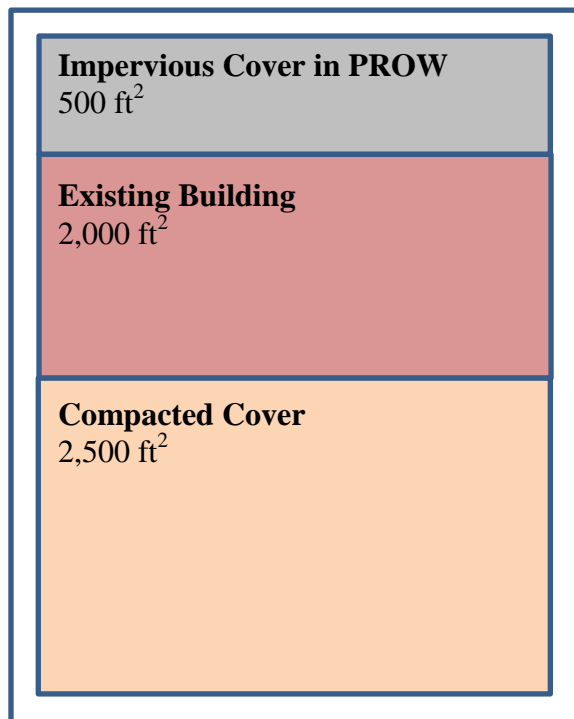
**SWRv Rainfall Depth for PROW Land Disturbance** = 1.2 inches (MEP)

**Example 8: Major Substantial Improvement - Building Renovation, Land Disturbance, and Land Disturbance in the Existing PROW**

A building with a footprint of 2,000 square feet with an assessed value of \$500,000 is being renovated at a cost of \$250,000. In addition, 3,000 square feet of adjacent land is being disturbed (including both the private property and the existing PROW) that will include a total of 3,000 square feet of impervious cover post-project, 500 square feet of which is in the PROW.

A stormwater management plan is required. The building renovation is considered a major substantial improvement activity. The cost of the renovations is at least 50% of its assessed value and is part of a total project footprint of at least 5,000 square feet with at least 2,500 square feet of post-project impervious area. In this scenario, impervious surface from both the PROW and existing building are counted together. Since the land disturbance is less than 5,000 square feet, the work is included in the major substantial improvement activity. Land disturbance in the existing PROW that is associated with either a major substantial improvement activity or a major land-disturbing activity is always required to meet the 1.2-inch standard to the MEP.

**Example 8 Site**



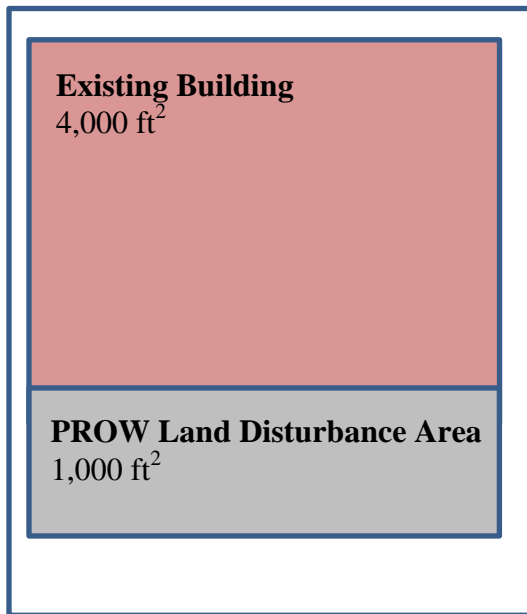
- Building Footprint** = 2,000 ft<sup>2</sup>
- Assessed Property Value** = \$500,000
- Renovation Cost** = \$250,000
- Percent of Property Value** = 50%
- Land Disturbance Area** = 3,000 ft<sup>2</sup>
- Total Compacted Cover** = 2,500 ft<sup>2</sup>
- Impervious in PROW** = 500 ft<sup>2</sup>
- Total Project Footprint** = 5,000 ft<sup>2</sup>
- Activity Type for Total Project**  
= Major Substantial Improvement
- SWRv Rainfall Depth for Building and Parcel Land Disturbance** = 0.8 inch
- SWRv Rainfall Depth for PROW Land Disturbance** = 1.2 inches (MEP)

**Example 9: Major Substantial Improvement - Building Renovation and Land Disturbance in Existing PROW.**

A building with a footprint of 4,000 square feet with an assessed value of \$700,000 is being renovated at a cost of \$350,000. In addition, 1,000 square feet of existing PROW is being disturbed.

A stormwater management plan is required. The building renovation is considered a major substantial improvement activity. The cost of the renovations is at least 50% of its assessed value; the building is part of a total project footprint of at least 5,000 square feet; and the project contains at least 2,500 square feet of post-project impervious area between the PROW and existing building. Since the land disturbance is less than 5,000 square feet, it is included in the major substantial improvement activity, including the land disturbance in the PROW. However, land disturbance in the PROW is always required to meet the 1.2-inch standard to the MEP.

**Example 9 Site**



**Building Footprint**= 4,000 ft<sup>2</sup>  
**Assessed Property Value** =\$700,000  
**Renovation Cost** = \$350,000  
**Percent of Property Value** = 50%

**PROW Land Disturbance Area**= 1,000 ft<sup>2</sup>

**Total Project Footprint** = 5,000 ft<sup>2</sup>

**Activity Type for Building and Land Disturbance** =  
 Major Substantial Improvement

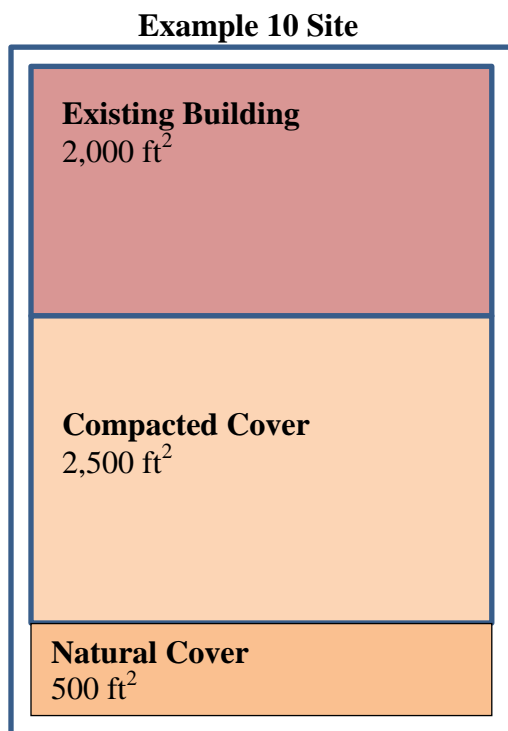
**SWRv Rainfall Depth for Building** = 0.8 inch

**SWRv Rainfall Depth for PROW Land Disturbance** = 1.2 inches (MEP)

**Example 10: Major Substantial Improvement - Building Renovation with Land Disturbance of Natural Cover**

A building with a footprint of 2,000 square feet with an assessed value of \$500,000 is being renovated at a cost of \$250,000. In addition, 3,000 square feet of adjacent land is being disturbed, including 500 square feet of natural cover.

A stormwater management plan is required. The building renovation is considered a major substantial improvement activity. The cost of the renovations is at least 50% of its assessed value and is part of a total project footprint of at least 5,000 square feet, in which some of the disturbance is pre-project natural cover. This project does not trigger a major land disturbing activity because the land disturbance is less than 5,000 square feet.



**Building Footprint**= 2,000 ft<sup>2</sup>  
**Assessed Property Value** = \$500,000  
**Renovation Cost** = \$250,000  
**Percent of Property Value** = 50%

**Land Disturbance Area**= 3,000 ft<sup>2</sup>  
**Total Compacted Cover** = 2,500 ft<sup>2</sup>  
**Total Natural Cover** = 500 ft<sup>2</sup>

**Total Project Footprint** = 5,000 ft<sup>2</sup>

**Activity Type for Total Project**  
 = Major Substantial Improvement

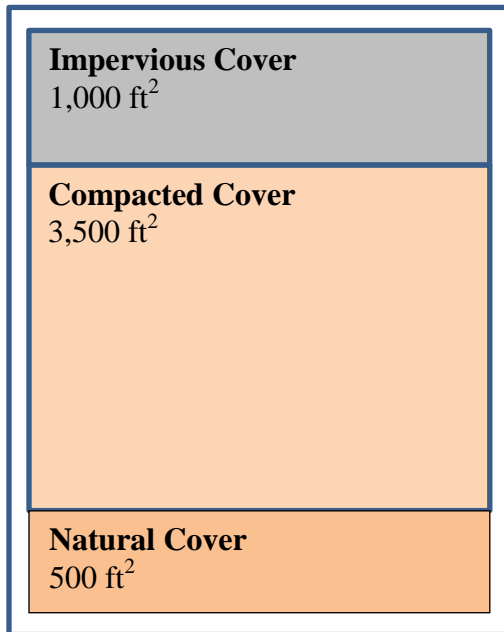
**SWRv Rainfall Depth for Building and Land Disturbance** = 0.8 inch

**Example 11: Major Land Disturbing Activity - Land Disturbance of Natural Cover.**

An area of 5,000 square feet is being disturbed (including 500 square feet of natural cover) that will include a total of 1,000 square feet of impervious cover post-project.

A stormwater management plan is required. The project is considered a major land disturbing activity. Although the post-project impervious land cover is less than 2,500 square feet, a portion of the pre-project land cover included natural cover and the total foot print of the project is at least 5,000 square feet.

**Example 11 Site**

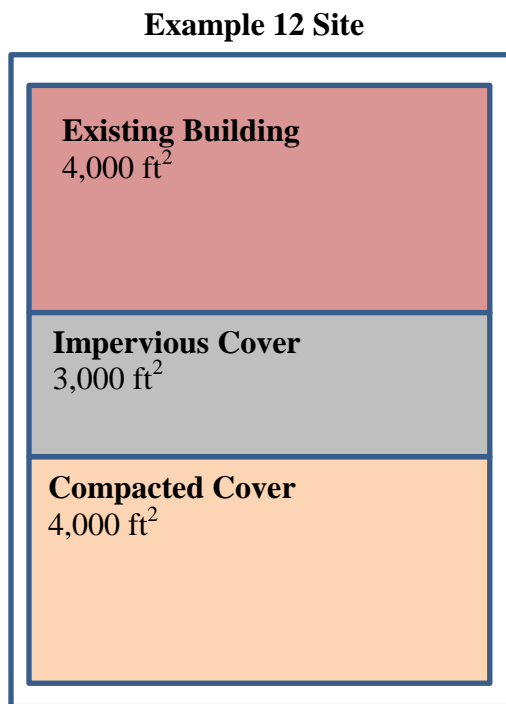


**Land Disturbance Area** = 5,000 ft<sup>2</sup>  
**Total Compacted Cover** = 3,500 ft<sup>2</sup>  
**Total Impervious Cover** = 1,000 ft<sup>2</sup>  
**Total Natural Cover** = 500 ft<sup>2</sup>  
**Total Project Footprint** = 5,000 ft<sup>2</sup>  
**Activity Type for Total Project**  
 = Major Land Disturbing  
**SWRv Depth for Land Disturbance** = 1.2 inches

**Example 12: Major Land Disturbing Activity - Building Renovation and Land Disturbance.**

A building with a footprint of 4,000 square feet and an assessed value of \$500,000 is being renovated at a cost of \$200,000. In addition, 7,000 square feet of adjacent land is being disturbed that will include a post-project total of 3,000 square feet of impervious cover.

A stormwater management plan is required. The building renovation is not considered a major substantial improvement activity. Although the footprint of the building and associated land disturbance exceeds 5,000 square feet, the cost of the renovation is less than 50% of its assessed value. However, the land disturbance is at least 5,000 square feet and includes at least 2,500 square feet of post-project impervious land cover; therefore, the land disturbance is considered a major land-disturbing activity. The building is not considered part of the regulated area for stormwater purposes.



**Building Footprint** = 4,000 ft<sup>2</sup>  
**Assessed Property Value** = \$500,000  
**Renovation Cost** = \$200,000  
**Percent of Property Value** = 40%

**Land Disturbance Area** = 7,000 ft<sup>2</sup>  
**Total Compacted Cover** = 4,000 ft<sup>2</sup>  
**Total Impervious Cover** = 3,000 ft<sup>2</sup>

**Activity Type for Total Project**  
 = Major Land Disturbing

**SWRv Rainfall Depth for Building** = N/A

**SWRv Rainfall Depth for Land Disturbance** = 1.2 inches

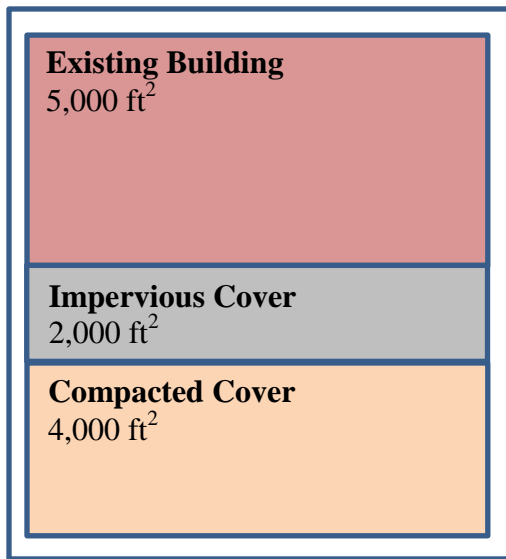


**Example 13: No Stormwater Regulated Activity - Building Renovations and Land Disturbance**

A building with a footprint of 5,000 square feet with an assessed value of \$500,000 is being renovated at a cost of \$200,000. In addition, 6,000 square feet of adjacent land is being disturbed that will include a total of 2,000 square feet of impervious cover post-project.

No stormwater management plan is required. The building renovation is not considered a major substantial improvement activity. Although the building’s footprint is at least 5,000 square feet, the cost of the renovations is less than 50% of its assessed value. The land disturbance is also not considered a major land-disturbing activity. Even though the land disturbance is at least 5,000 square feet, it includes less than 2,500 square feet of post-project impervious land cover.

**Example 13 Site**



**Building Footprint**= 5,000 ft<sup>2</sup>  
**Assessed Property Value** = \$500,000  
**Renovation Cost** = \$200,000  
**Percent of Property Value** = 40%

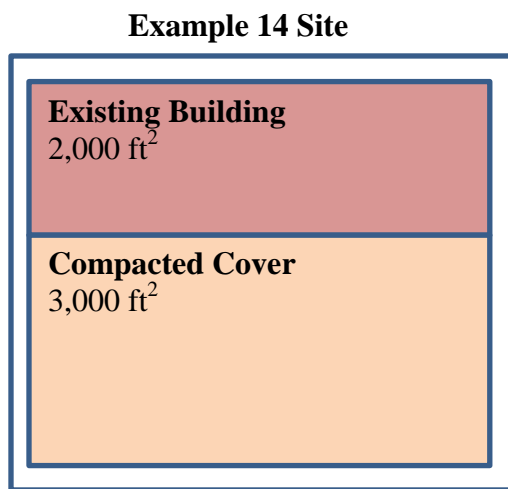
**Land Disturbance Area**= 6,000 ft<sup>2</sup>  
**Total Compacted Cover** = 4,000 ft<sup>2</sup>  
**Total Impervious Cover** = 2,000 ft<sup>2</sup>

**Activity Type for Total Project** = N/A

***Example 14: No Stormwater Regulated Activity - Building Renovations and Land Disturbance.***

A building with a footprint of 2,000 square feet and an assessed value of \$500,000 is being renovated at a cost of \$250,000. In addition, 3,000 square feet of adjacent land is being disturbed, but will have no impervious cover post-project.

No stormwater management plan is required. This project is neither a major land disturbing nor a major substantial improvement activity. Although the total project footprint is at least 5,000 square feet and the cost of the building renovations is at least 50% of its assessed value, the total impervious cover for the site is less than 2,500 square feet and there is no natural land cover being disturbed.



**Building Footprint = 2,000 ft<sup>2</sup>**  
**Assessed Property Value = \$500,000**  
**Renovation Cost = \$250,000**  
**Percent of Property Value = 50%**

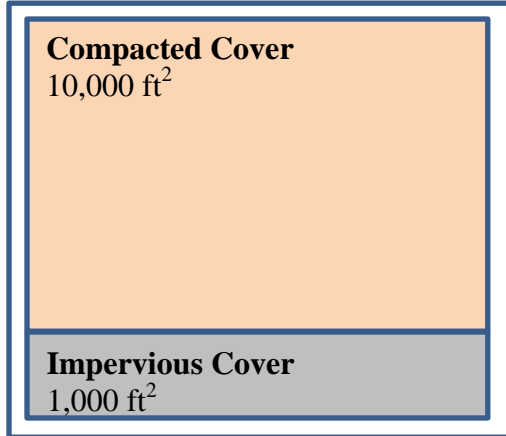
**Land Disturbance Area = 3,000 ft<sup>2</sup>**  
**Total Compacted Cover = 3,000 ft<sup>2</sup>**  
**Total Impervious Cover = 0 ft<sup>2</sup>**

**Total Project Footprint = 5,000 ft<sup>2</sup>**  
**Activity Type for Total Project = N/A**

***Example 15: No Stormwater Regulated Activity - Land Disturbance***

An 11,000 square foot area is being disturbed, of which only 1,000 square feet will be impervious. Since the post-project impervious cover is less than 2,500 square feet, the project is not considered a major land disturbing activity. No stormwater management plan is required.

**Example 15 Site**



**Land Disturbance Area**= 11,000 ft<sup>2</sup>  
**Total Compacted Cover** = 10,000 ft<sup>2</sup>  
**Total Impervious Cover** = 1,000 ft<sup>2</sup>

**Activity Type for Total Project** = N/A



# Appendix W Site Drainage Area and BMP Design Diagrams

## W.1 Design Diagram Overview

Section U.2 Site Drainage Area Diagrams illustrates how to determine a project's Site Drainage Areas (SDAs) when designing a Stormwater Management Plan (SWMP). Section V.3, "Determining When BMP Performance is Considered to be On-Site" illustrates how to determine whether the retention, treatment, and storage volumes achieved by a stormwater best management practice (BMP) should be considered "on-site" in determining compliance with performance requirements for the project.

Each diagram is intended to illustrate conceptual designs. The diagrams are not intended to illustrate preferred design options and are not drawn to scale.

## W.2 Site Drainage Area Diagrams

As described in Chapter 2, "Minimum Control Requirements," an SDA is the area that drains to a point of discharge (or sheet flow) from the site. These diagrams may be used to assist in defining SDAs. Each diagram represents a project with more than one discharge point. In many cases, a site will only have one discharge point, resulting in one SDA.

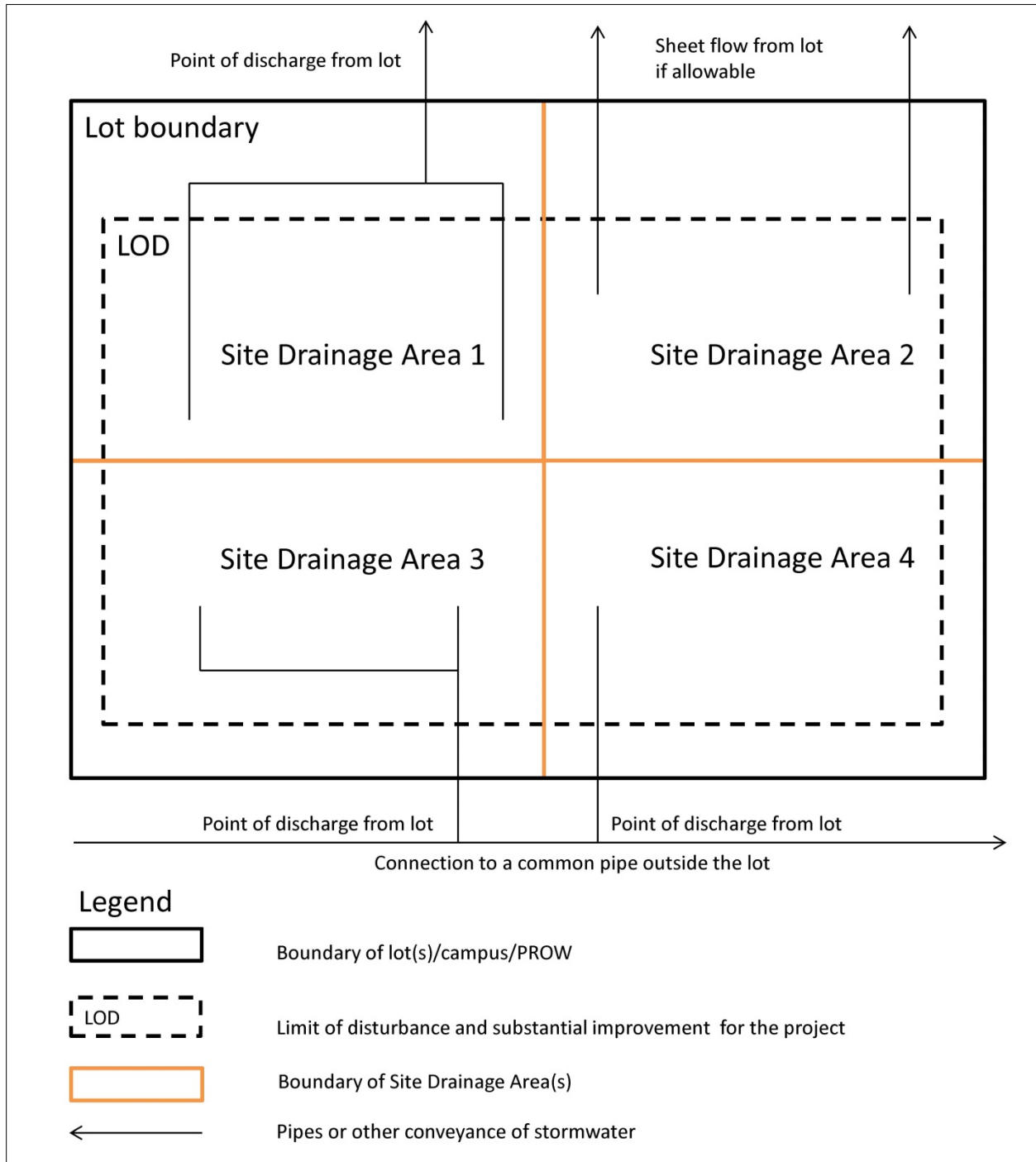
The following diagrams can be used to determine SDA boundaries based on the type of project:

**Projects Disturbing a Single Lot.** Each point of discharge (or sheet flow) will be determined based on the boundary of the lot.

**Projects Disturbing Many Lots (including common plans of development).** Each point of discharge (or sheet flow) will be determined based on the external boundaries of all lots. The internal lot boundaries between the disturbed lots may be disregarded when determining SDA points of discharge (or sheet flow).

**Projects Occurring on Campuses.** Each point of discharge (or sheet flow) will be determined based on the boundary of the limit of disturbance (LOD) and/or Major Substantial Improvement activity.

Figure W.1 shows the determination of SDA boundaries for projects occurring on a single lot. The site boundary is the same as the lot boundary, so each SDA is based on the point of departure or sheet flow from the lot (and not the LOD for the project). In SDA 1, although there are two points of discharge from the LOD, these pipes come together within the site and exit the site from a single point of departure, making it one SDA. Individual discharge points from the site that connect to a common pipe outside the lot are considered separate SDAs.



**Figure W.1 Site Drainage Areas on a single lot.**

Figure V.2 shows the determination of SDA boundaries for project occurring on multiple lots. The site boundary is the same as the external boundaries of the group of disturbed lots. The LOD and any internal lot boundaries are not considered in determining the SDA boundaries. For example, although stormwater may cross from one lot to another before departing the site, these are not considered separate SDAs. Individual discharge points from the site that connect to a common pipe outside the lots are considered separate SDAs.

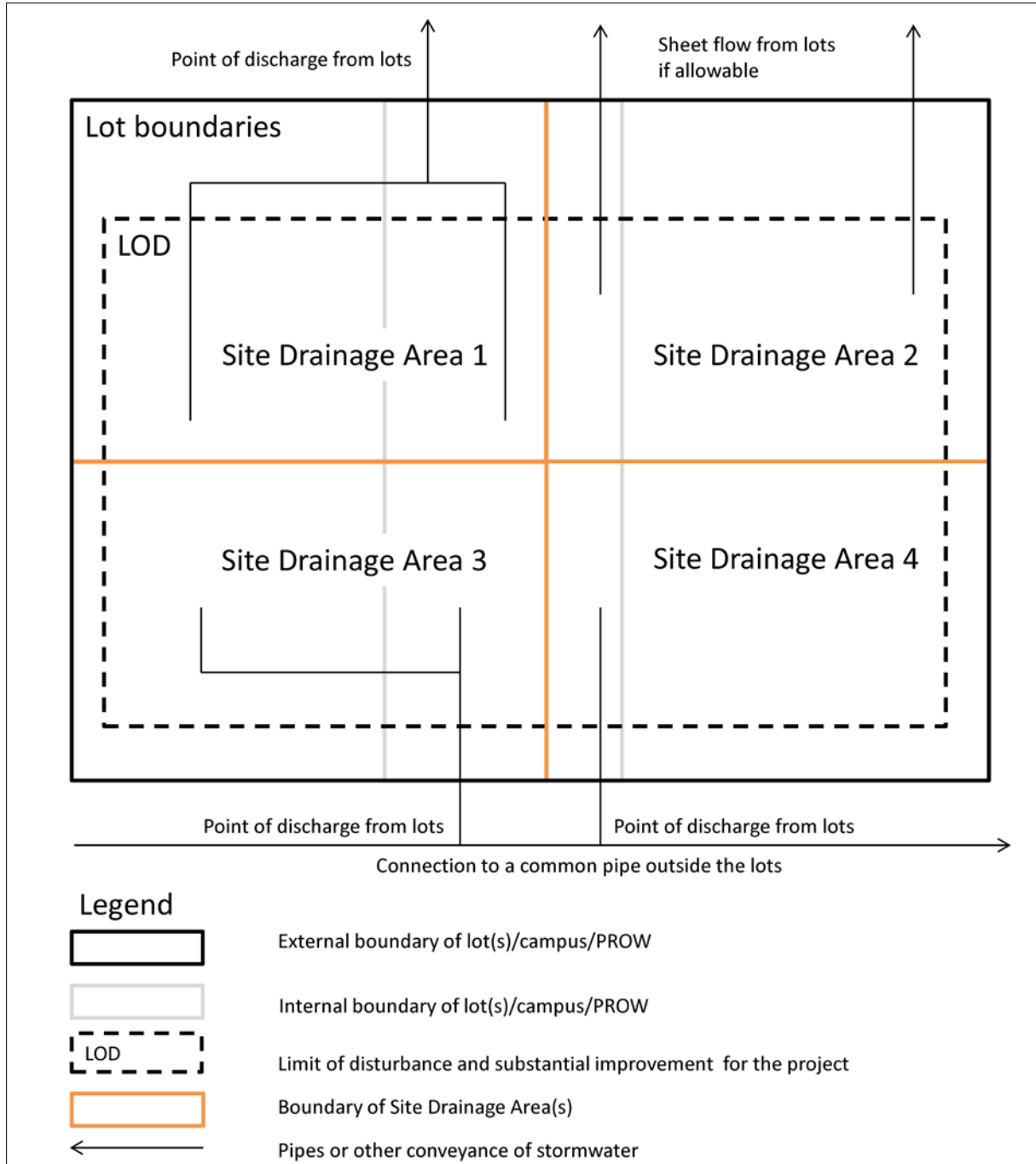


Figure W.2 Site Drainage Areas on projects with multiple lots.

Figure V.3 shows the determination of SDA boundaries on a campus. Each SDA is defined based on the point of departure or sheet flow from the LOD, rather than campus boundaries. Individual discharge points from the LOD that connect to a common pipe outside the LOD are considered separate SDAs.

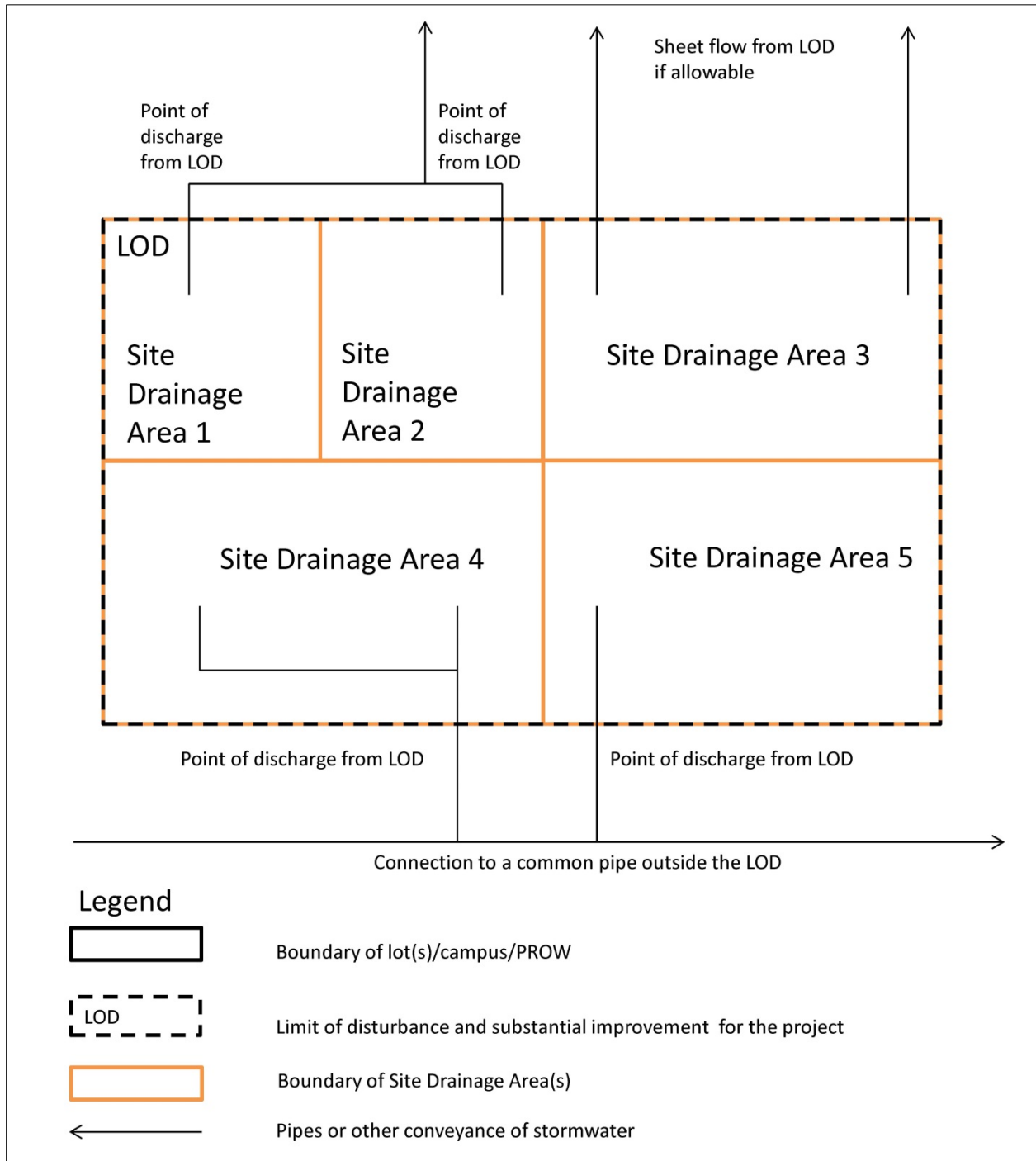


Figure W.3 Site Drainage Areas on campuses.



### W.3 Determining When BMP Performance is Considered to be On-Site

This section illustrates BMP design scenarios and clarifies whether the retention, treatment, and storage volumes achieved by a BMP may be considered “on-site” in determining compliance with performance requirements for the project. For simplicity, these diagrams only depict whether a single BMP’s performance may be considered on-site. The project must comply with all other regulatory requirements. This may include minimum performance requirements for SDAs or design of additional BMPs.

These diagrams assume that the BMPs depicted meet all other design requirements specified in this guidebook. For simplicity in illustrating these design scenarios, each diagram assumes there is only one SDA. Each diagram evaluates a single BMP, but additional BMPs may be necessary to meet the site’s performance requirements.

BMPs may achieve a retention, treatment, or storage volume that cannot be used to meet on-site performance requirements. In these cases, the volume that meets on-site performance requirements is proportional to the volume of runoff received by the BMP from qualifying contributing drainage area (CDA), as depicted in the design scenario. The volume that is not considered on-site may be eligible for SRC certification according to Chapter 7, “Generation, Certification, Trading, and Retirement of Stormwater Retention Credits” of this guidebook.

**Project Disturbing a Single Lot.** Figure V.4 through Figure V.12 depict design scenarios that are applicable to projects that disturb a single lot.

**Projects Disturbing Many Lots (including common plans of development).** Figure V.13 through Figure V.22 depict design scenarios that are applicable to projects that disturb many lots. In these examples, all of the disturbed lots are reviewed by DOEE on a single SWMP. This may be applicable for common plans of development. As the lots are developed under a common plan, the project’s performance requirements and compliance may be calculated jointly. However, the SWMP and covenant should state the portion of the performance requirement that is calculated for each lot. If at some point in the future, some of the lots are redeveloped or a BMP maintenance issue arises, each lot may be responsible for achieving compliance with its own portion of the performance requirements.

**Projects Occurring on Campuses.** Figure V.23 through Figure V.27 depict design scenarios that are applicable to projects that occur on campuses (universities, hospitals, or similar properties).

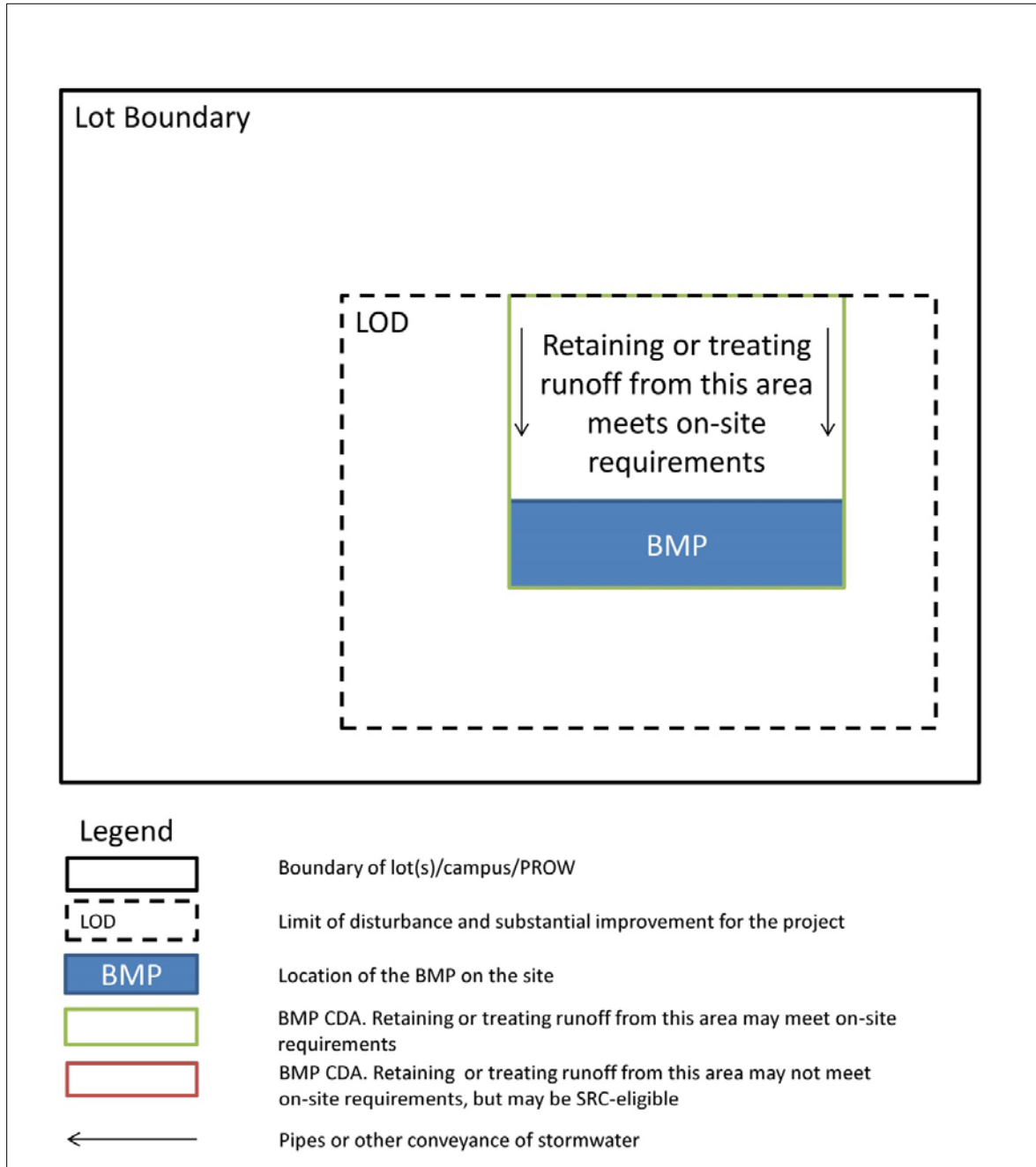
**Projects Occurring in the Public Right-of-Way (PROW).** Figure V.28 through Figure V.32 depict design scenarios that are applicable to projects, or portions of projects, that occur in the PROW.

**Shared BMPs.** In some cases, DOEE may approve the use of a shared BMP between two or more SWMPs. A shared BMP may meet on-site requirements for each SWMP that has CDA to the shared BMP, as shown in Figure V.33. The portion of the volume achieved by the shared BMP that meets on-site requirements for a project is proportional to the runoff volume received from the site where that project is occurring. Shared BMPs must be entered into the Stormwater

Database and represented on the SWMP as directed by DOEE, identifying the CDA to the shared BMP from each site.

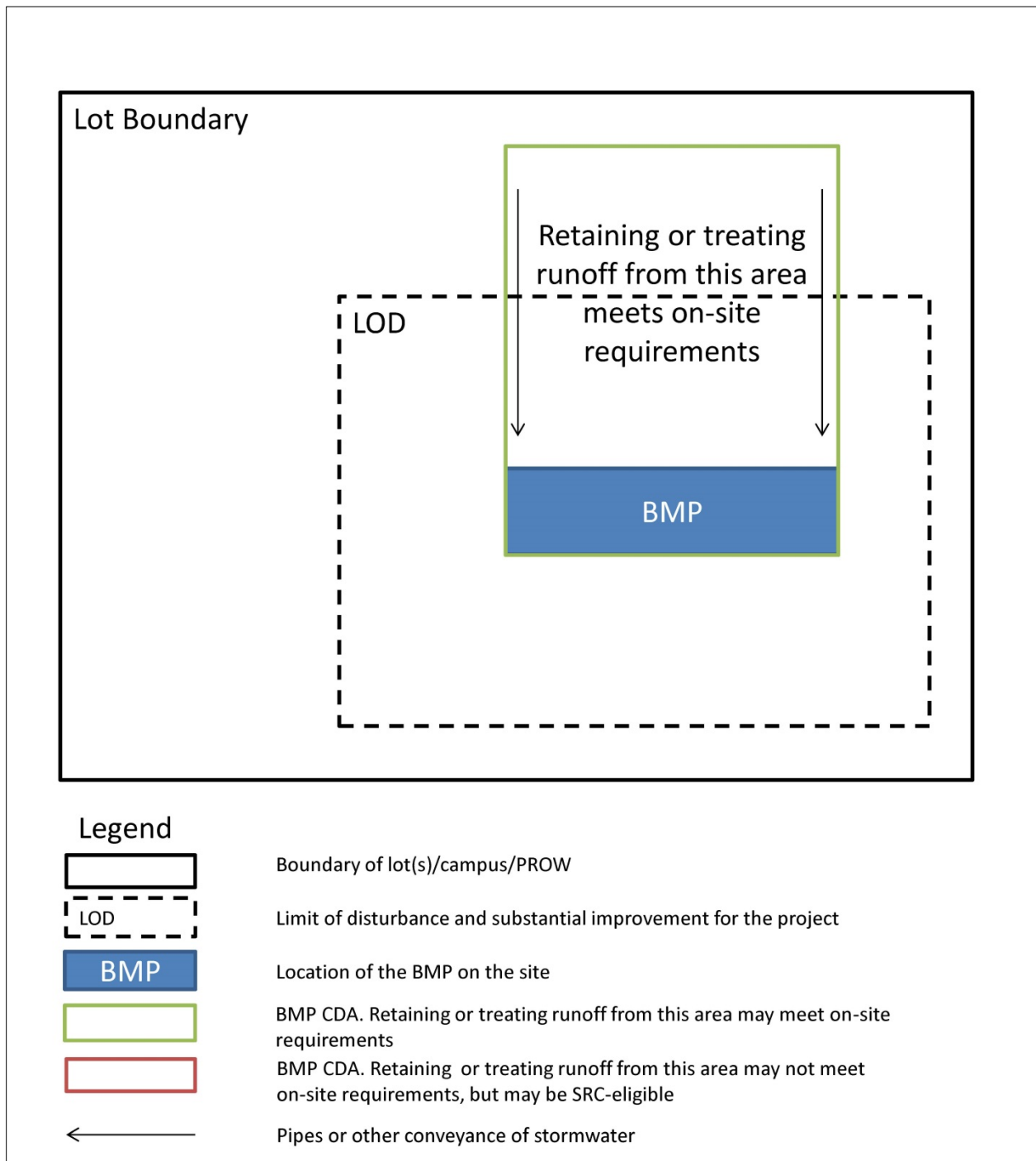
When a shared BMP is used, each project may have a maintenance obligation for the BMP and its CDA. If so, each SWMP and declaration of covenants must show this responsibility for maintaining the shared BMP. Furthermore, the SWMP and Declaration must show that if, at some point in the future, stormwater management is no longer provided by the shared BMP, the site is responsible for managing stormwater either on site or through a combination of on-site and off-site retention.

Figure W.4 shows that if a BMP and its entire CDA are within the LOD, any retention or treatment volume achieved by the BMP may meet on-site requirements.



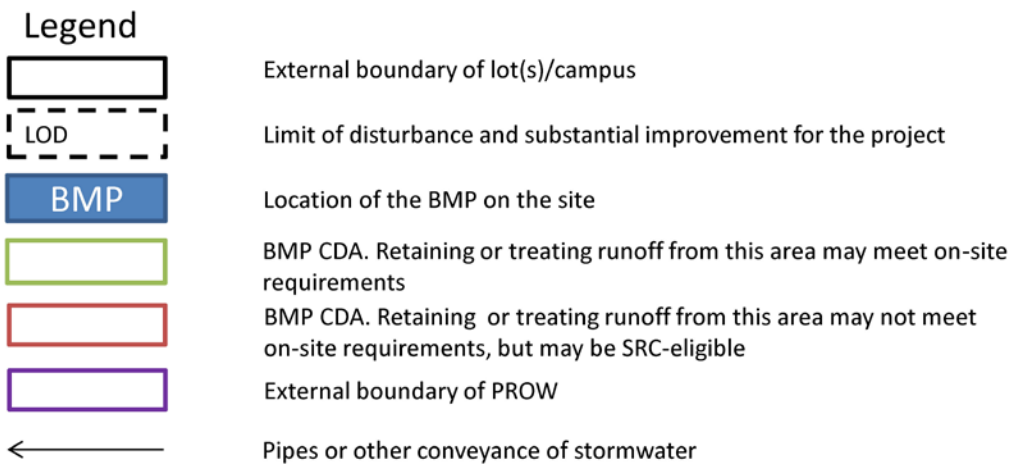
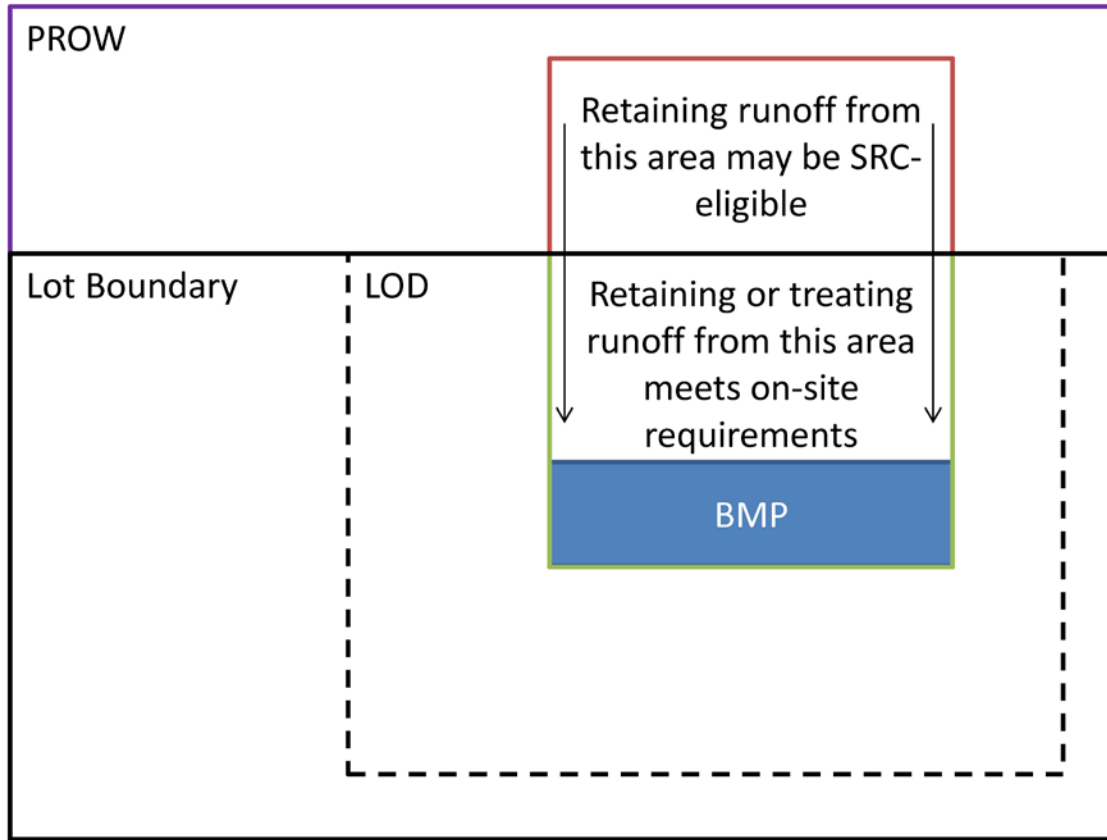
**Figure W.4 Single lot: BMP and CDA are entirely within the LOD.**

Figure W.5 shows that if a BMP is within the LOD and the entire CDA is within the lot that is being disturbed, any retention or treatment volume achieved by the BMP may meet on-site requirements.



**Figure W.5 Single lot: CDA is partially outside the LOD, but within the lot.**

Figure W.6 shows that if a BMP's CDA includes any area from the PROW, any retention or treatment volume achieved may partially meet on-site requirements.



**Figure W.6 Single lot: CDA is partially in the PROW.**

Figure W.7 shows that if a BMP's CDA includes any area from an adjacent lot that is not part of the project, any retention or treatment volume achieved by the BMP may partially meet on-site requirements.

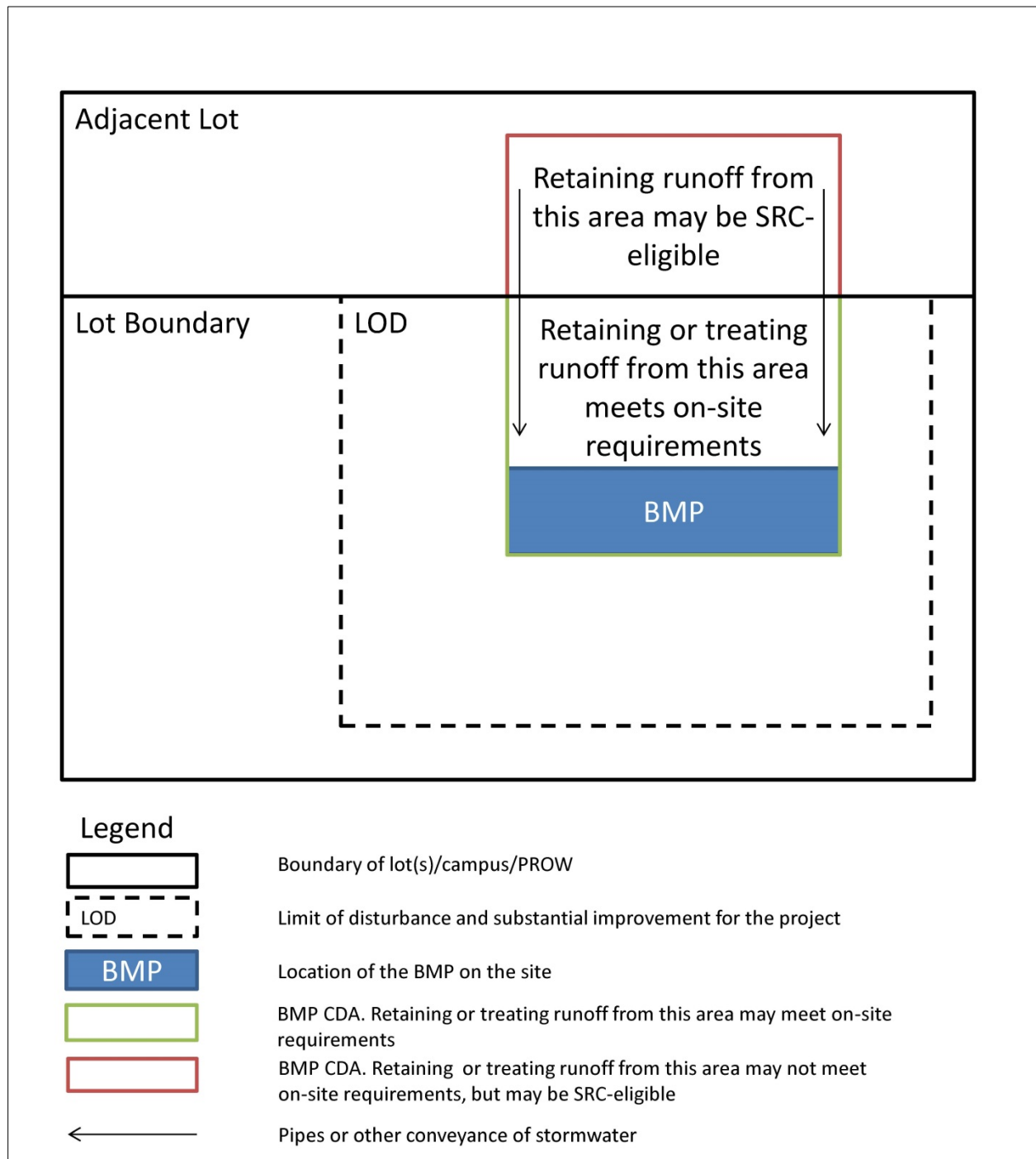
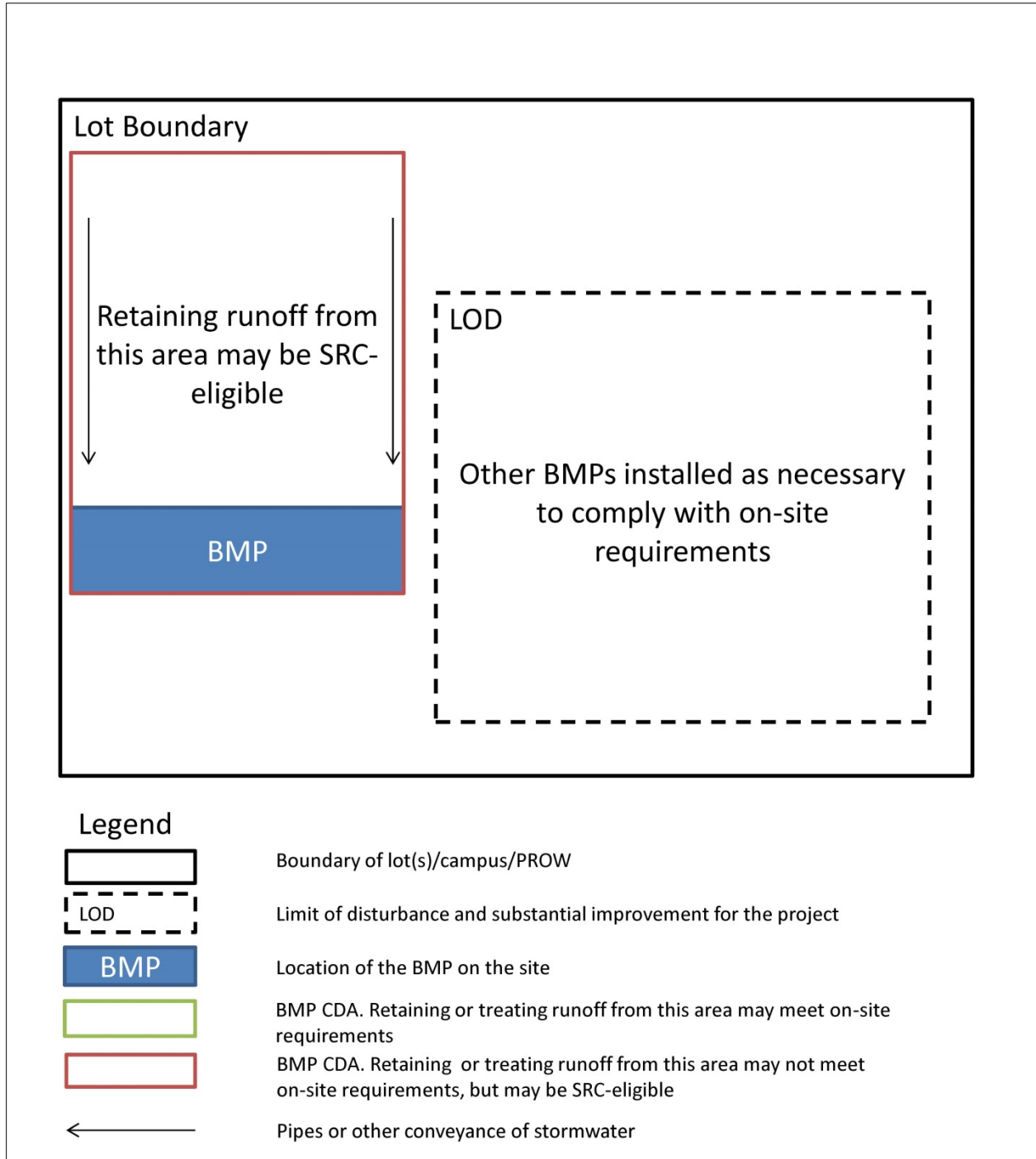


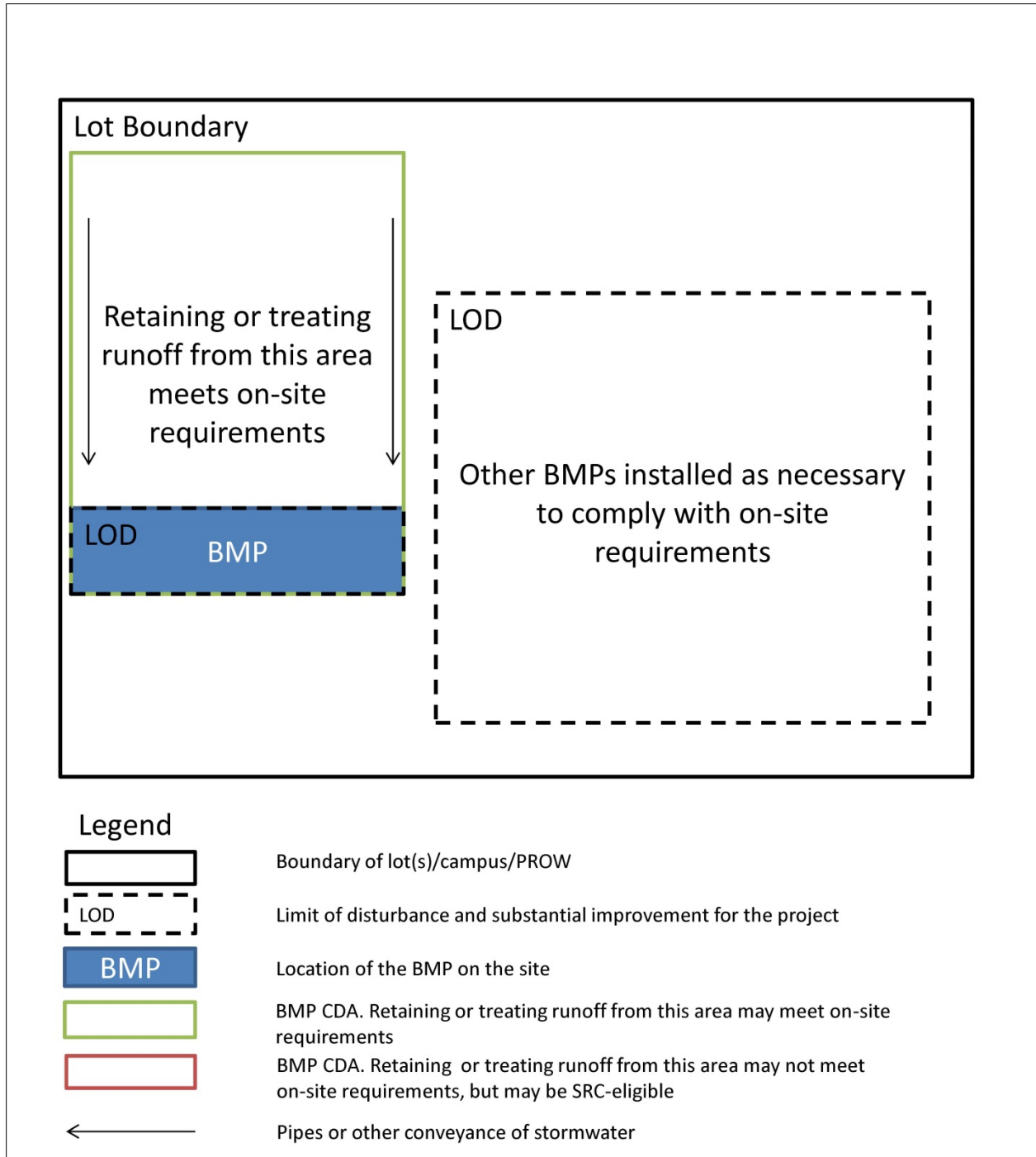
Figure W.7 Single lot: CDA includes area on an adjacent lot.

Figure W.8 shows that if a BMP is installed outside the LOD, and receives no runoff from the LOD, it may be considered voluntary and generate SRCs. However, no retention or treatment volume achieved may meet on-site performance requirements. If the applicant wishes to use the BMP to meet on-site requirements, refer to Figure W.9.



**Figure W.8 Single lot: BMP and CDA are entirely outside the LOD.**

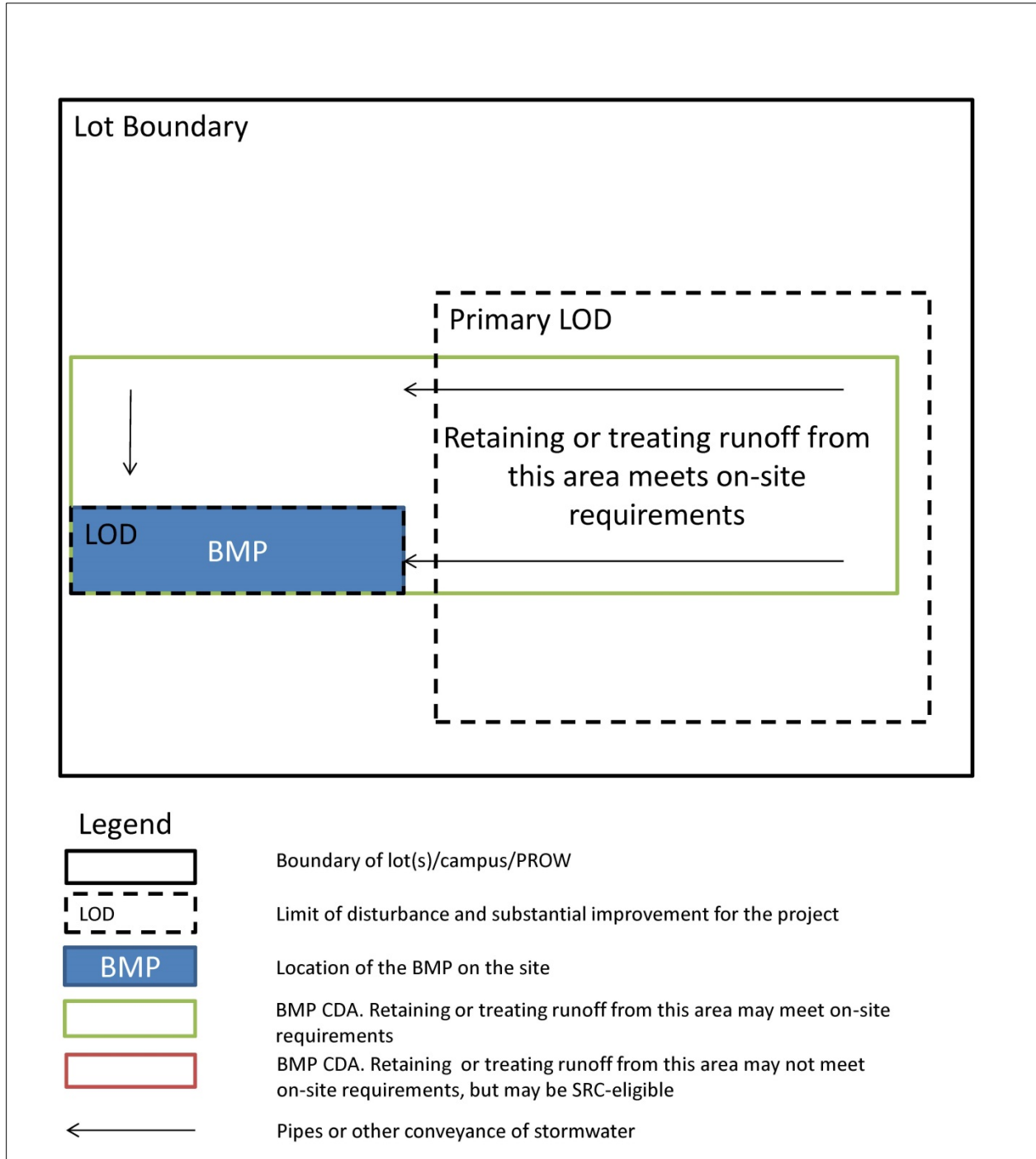
Figure W.9 shows that if a BMP is installed outside the LOD for a project, any retention or treatment volume achieved by the BMP may meet on-site requirements if the BMP's surface is considered part of the LOD. Performance requirements are calculated for this additional LOD. If the applicant wishes to install the BMP voluntarily without increasing the LOD, refer to Figure W.8.



**Figure W.9 Single lot: BMP and CDA are outside primary LOD.**

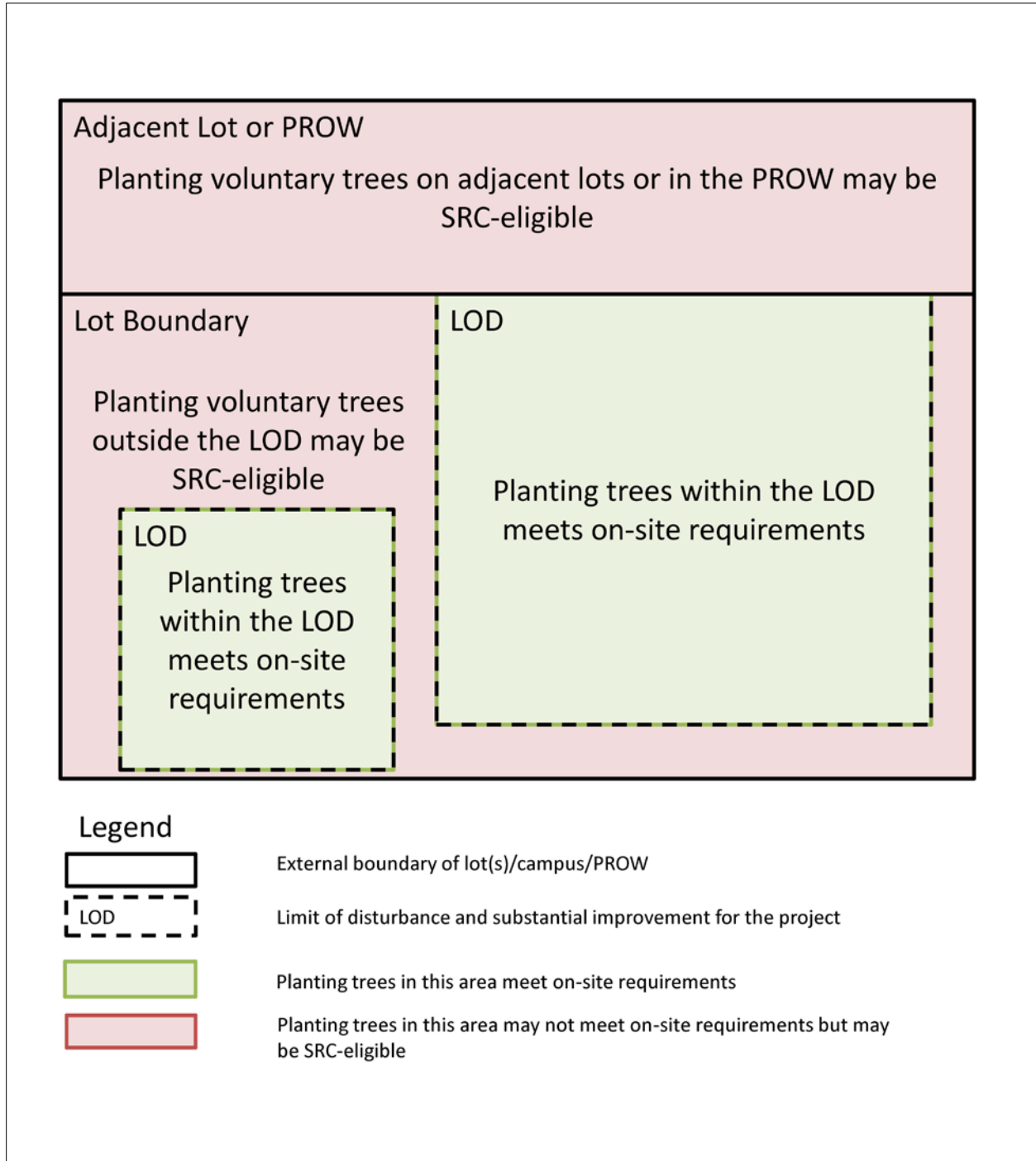


Figure W.10 shows that if a BMP is installed outside the LOD for a project, but receives runoff from within the LOD, DOEE will also consider the surface of the BMP to be part of the LOD. Performance requirements are calculated for this additional LOD. Any retention or treatment achieved by the BMP may meet on-site requirements.



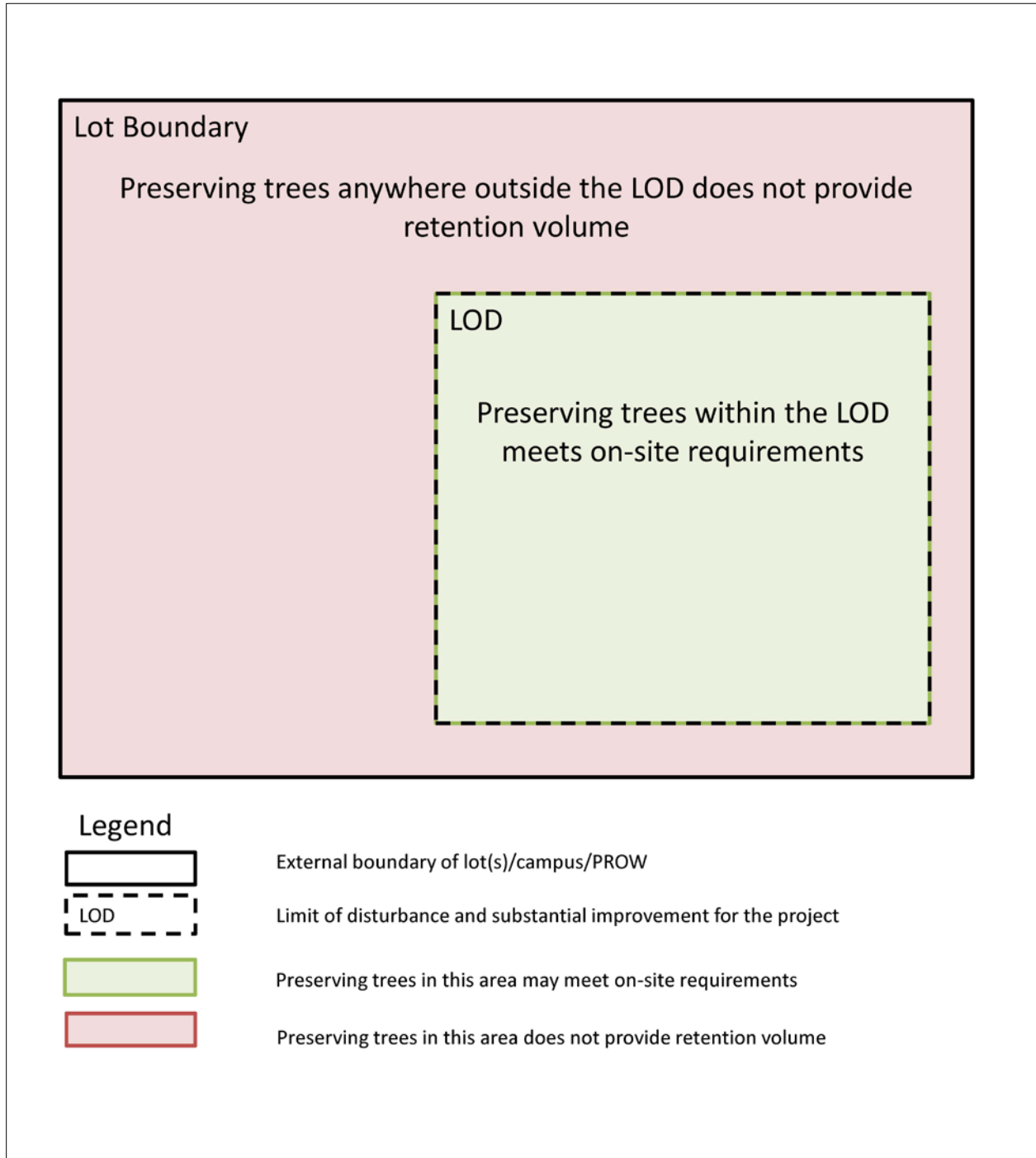
**Figure W.10 Single lot: BMP is outside primary LOD; CDA includes area within primary LOD.**

Figure W.11 shows that planting trees within the LOD may meet on-site requirements. Land disturbance associated with tree planting is considered part of the LOD for the project. Alternatively, trees may be planted outside of the LOD to generate SRCs without increasing the LOD, but these trees will not meet on-site requirements.



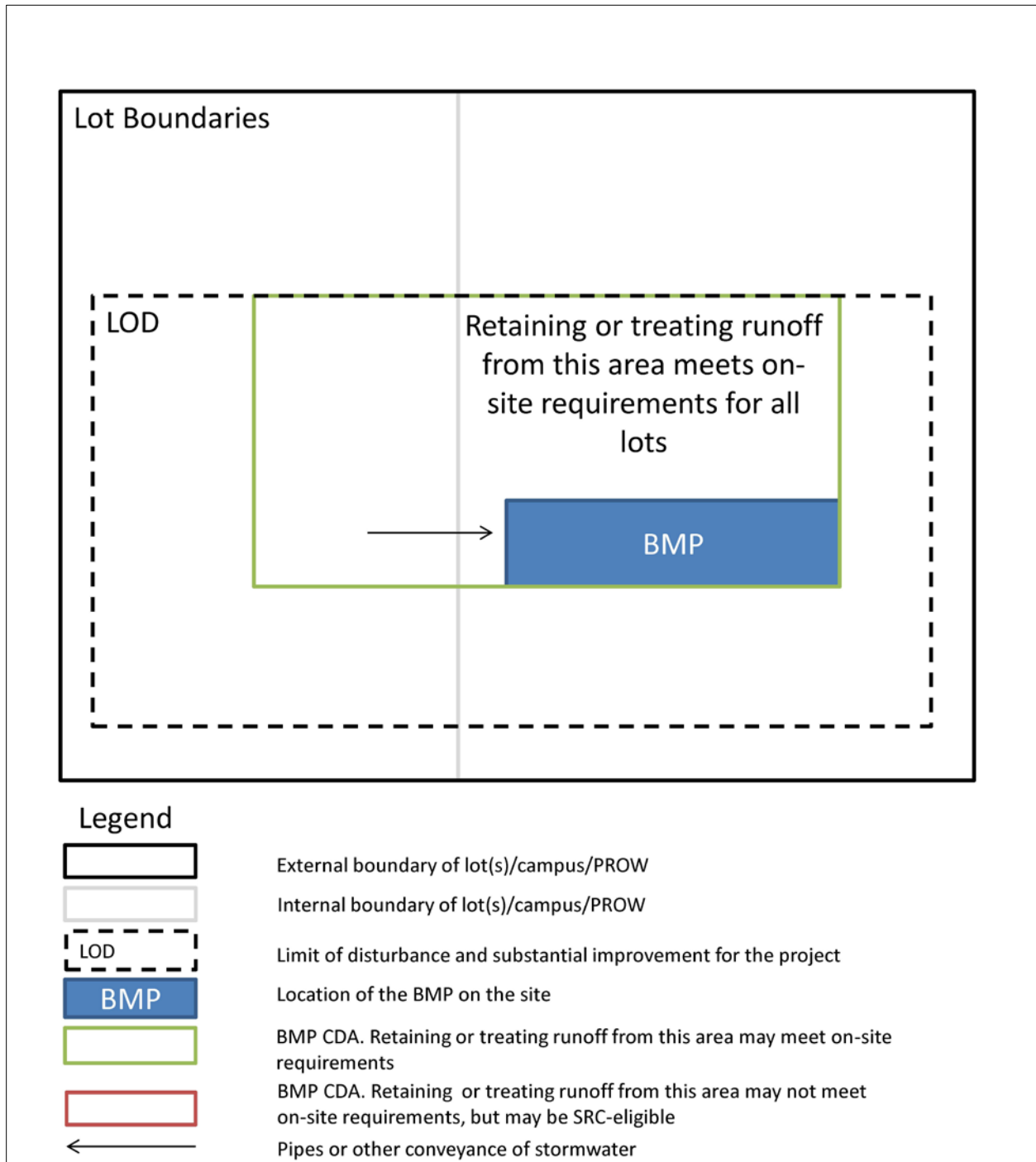
**Figure W.11 Single lot: Tree planting.**

Figure W.12 shows that preserving trees anywhere within the LOD may meet on-site requirements. Generally, preserving trees outside the LOD does not provide a retention volume.



**Figure W.12 Single lot: Tree preservation**

Figure W.13 shows that if a BMP and its entire CDA are within the LOD, any retention or treatment volume achieved by the BMP may meet on-site requirements for all lots.



**Figure W.13 Many lots: BMP and CDA are entirely within the LOD.**

Figure W.14 shows that if a BMP is within the LOD and the entire CDA is within the disturbed lots, any retention or treatment volume achieved by the BMP may meet on-site requirements for all lots.

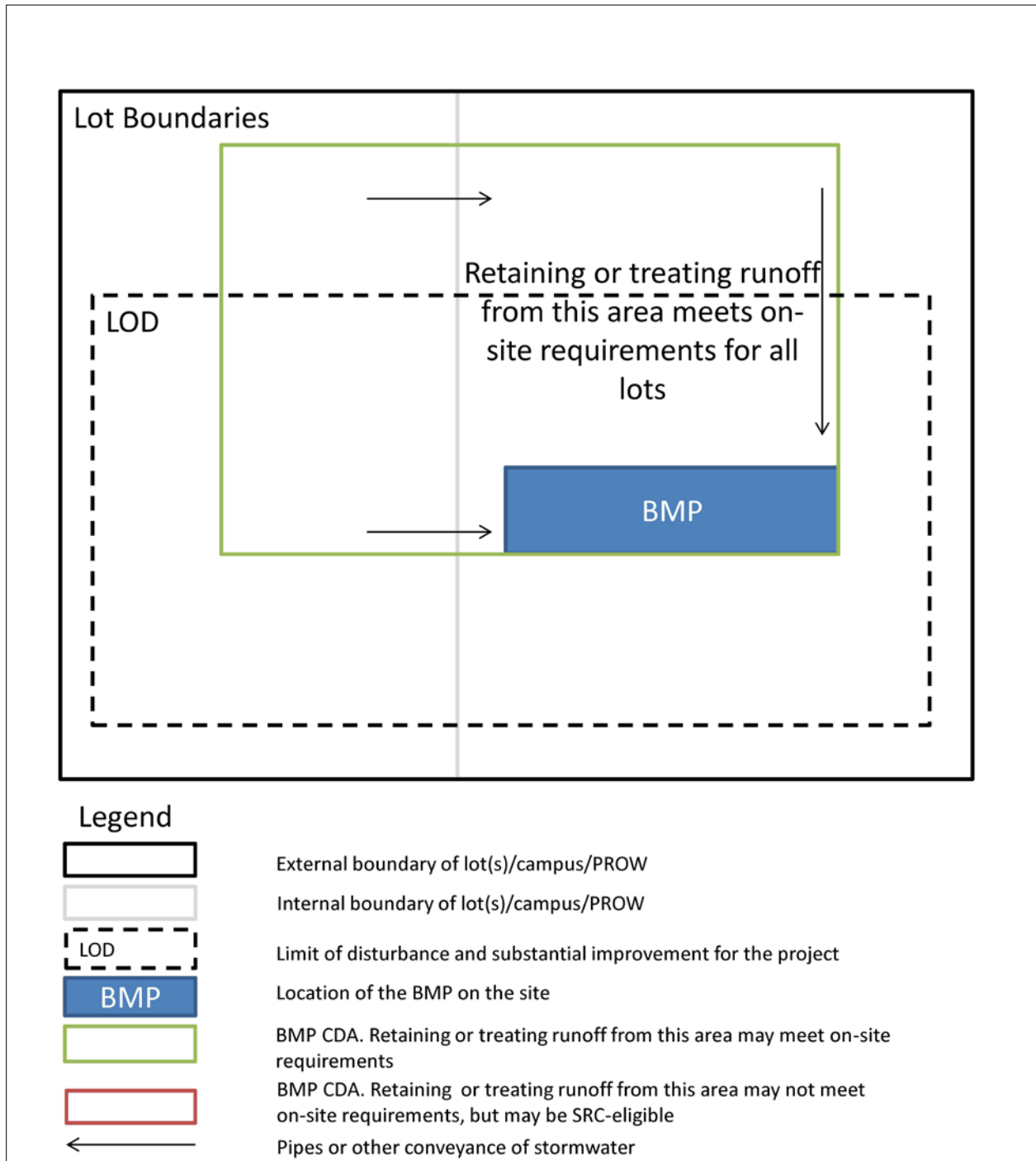
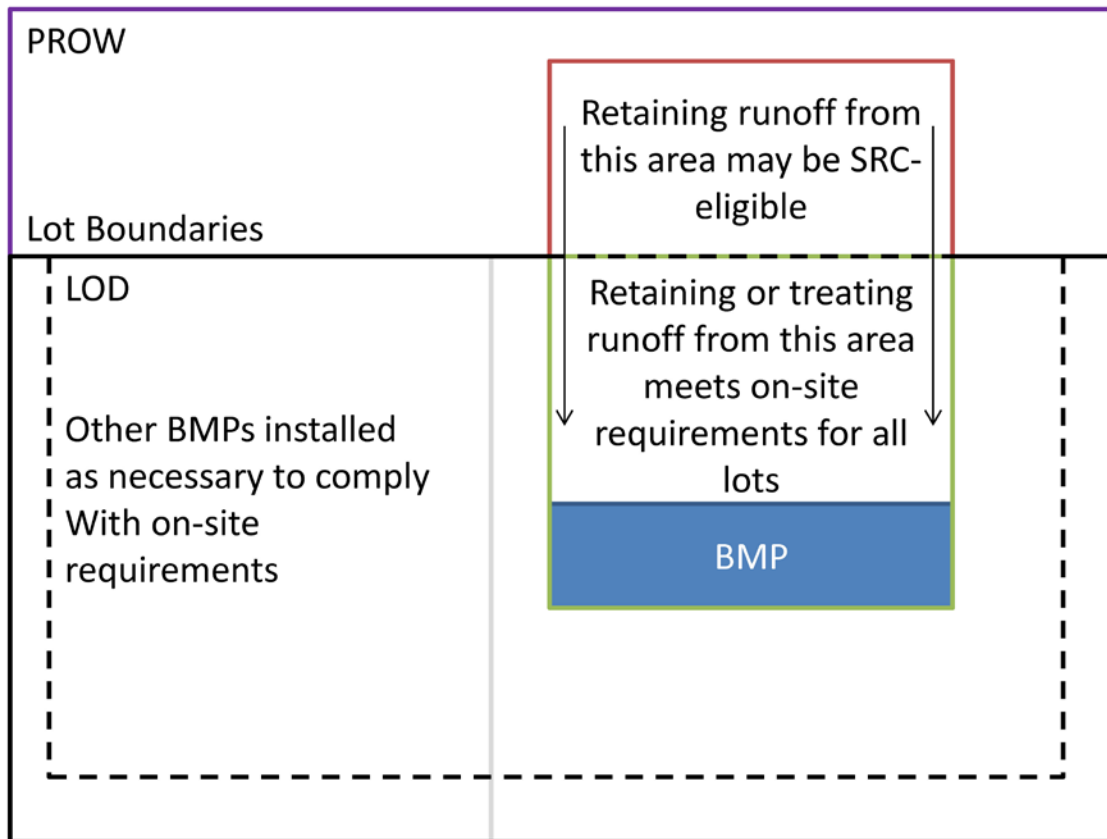
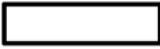
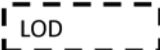







Figure W.14 Many lots: CDA is partially outside the LOD, but within the disturbed lots.

Figure W.15 shows that if a BMP's CDA includes any area from the PROW, the retention or treatment of runoff from the PROW does not meet on-site requirements.

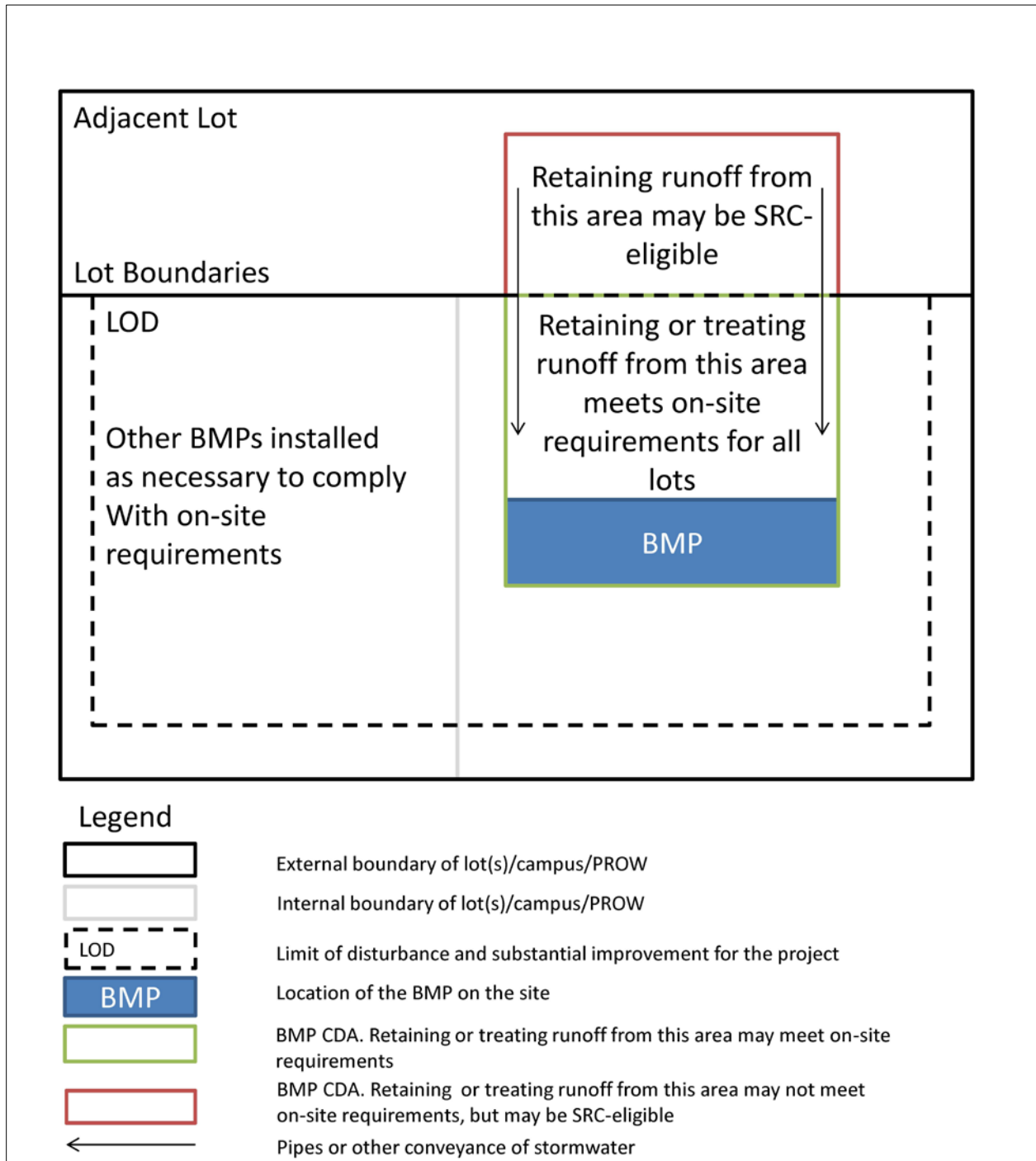


Legend

-  External boundary of lot(s)/campus
-  LOD
-  BMP
-  BMP CDA. Retaining or treating runoff from this area may meet on-site requirements
-  BMP CDA. Retaining or treating runoff from this area may not meet on-site requirements, but may be SRC-eligible
-  External boundary of PROW
-  Pipes or other conveyance of stormwater

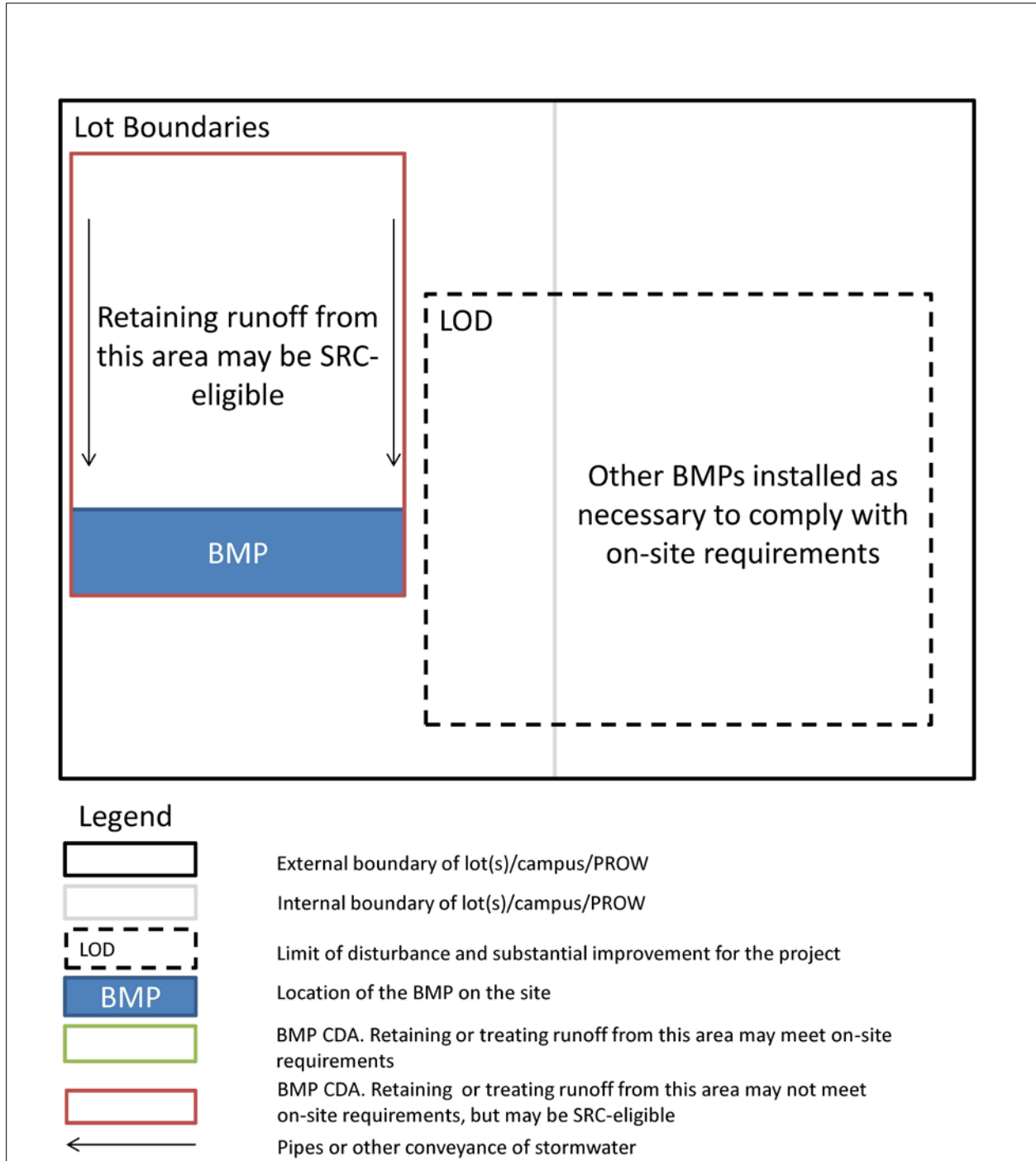
**Figure W.15 Many lots: CDA is partially in the PROW.**

Figure W.16 shows that if a BMP’s CDA includes any area from an adjacent lot that is not part of the project, the retention or treatment of runoff from the adjacent lot does not meet on-site requirements.



**Figure W.16 Many lots: CDA includes area on an adjacent lot.**

Figure W.17 shows that if a BMP is installed outside the LOD on one of the disturbed lots, and receives no runoff from the LOD, it may be considered voluntary and generate SRCs. However, no retention or treatment volume achieved may meet on-site requirements. If the applicant wishes to use the BMPs to meet on-site requirements, refer to Figure W.23.



**Figure W.17 Many lots: BMP and CDA are entirely outside the LOD.**



Figure W.18 shows that if a BMP is installed on an adjacent lot that is not part of the project, it may be considered voluntary and generate SRCs. However, no retention or treatment volume achieved by the BMP may meet on-site requirements. If the applicant wishes to use this BMP to meet on-site requirements, refer to Figure V.19.

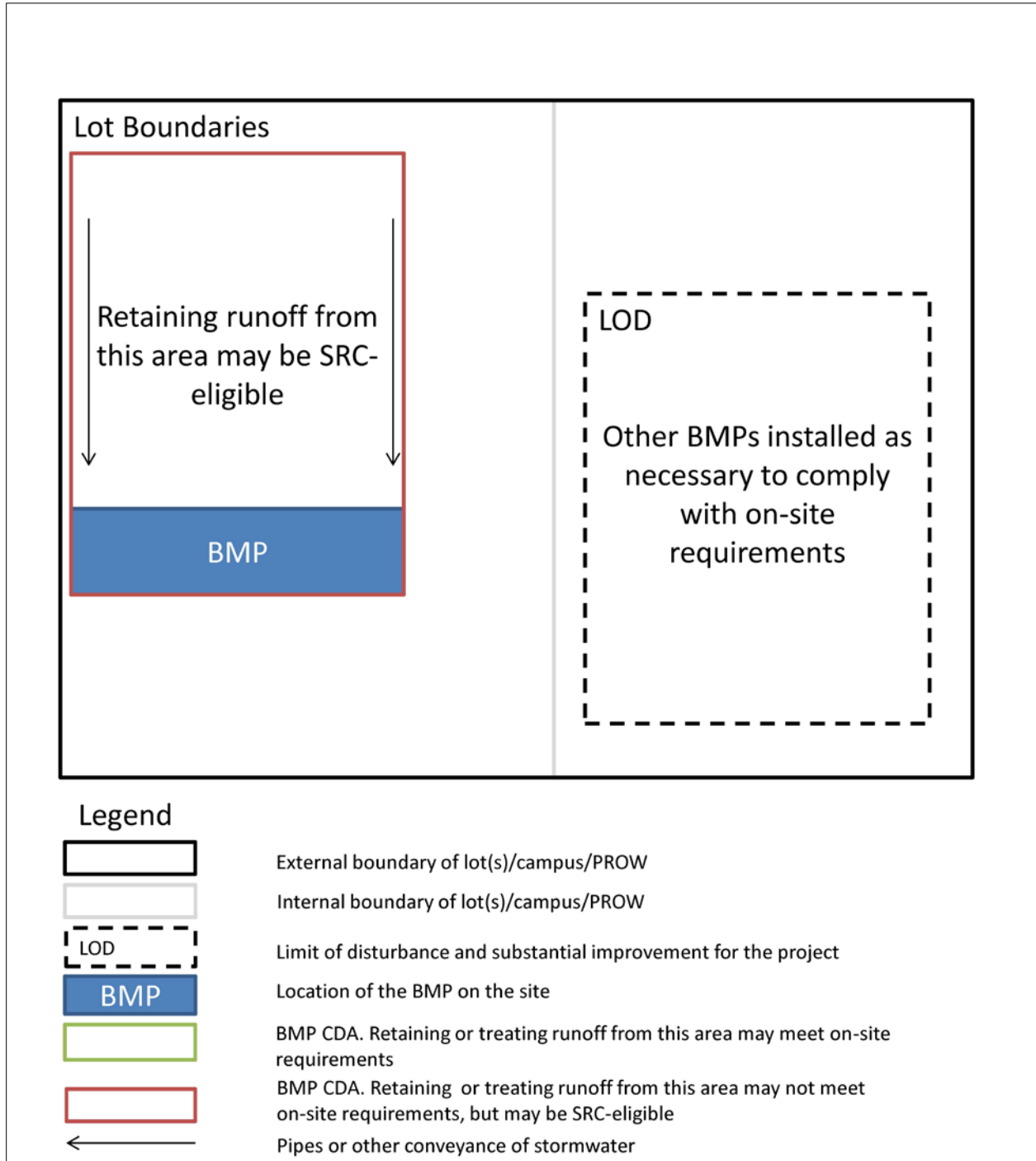
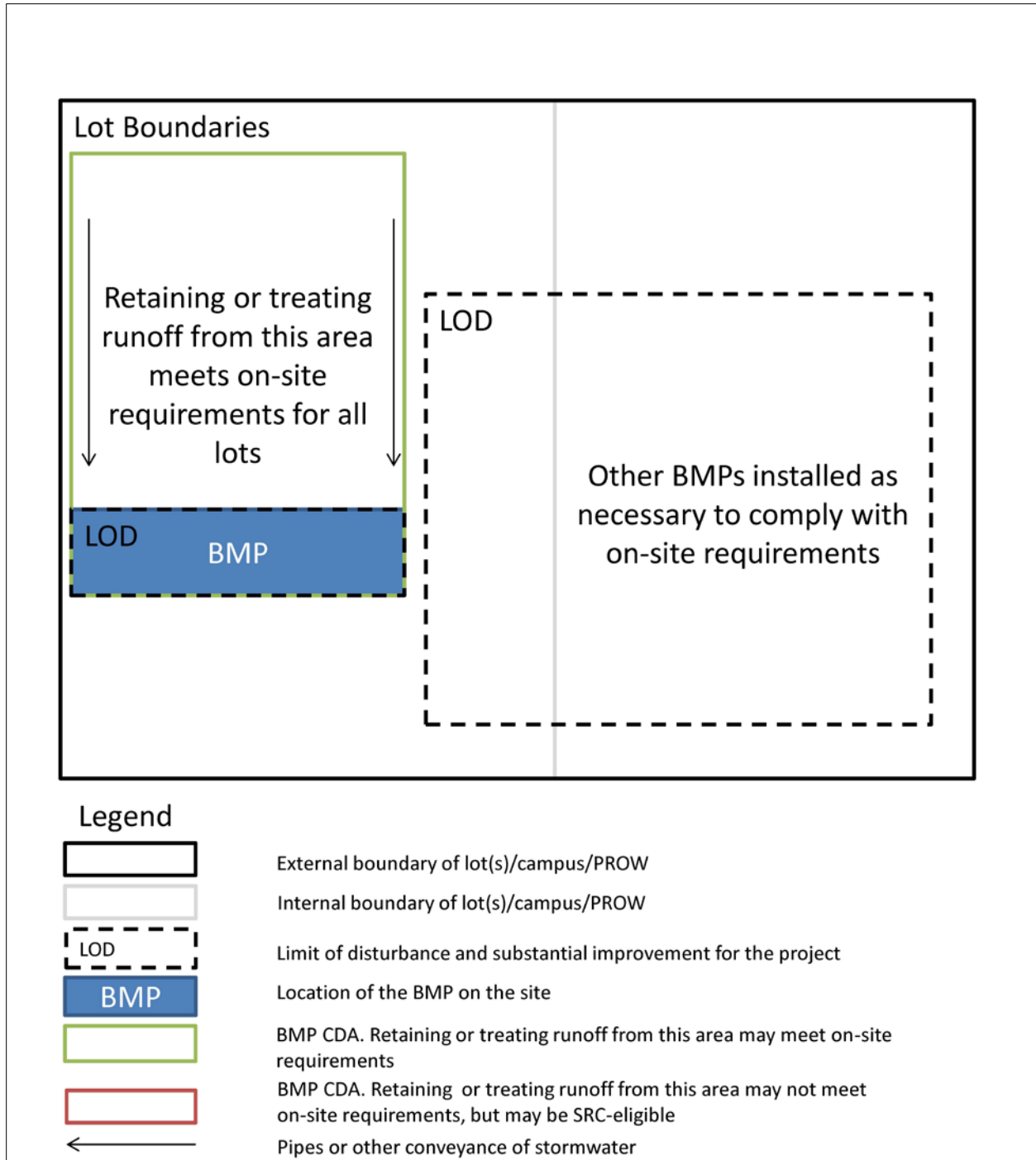


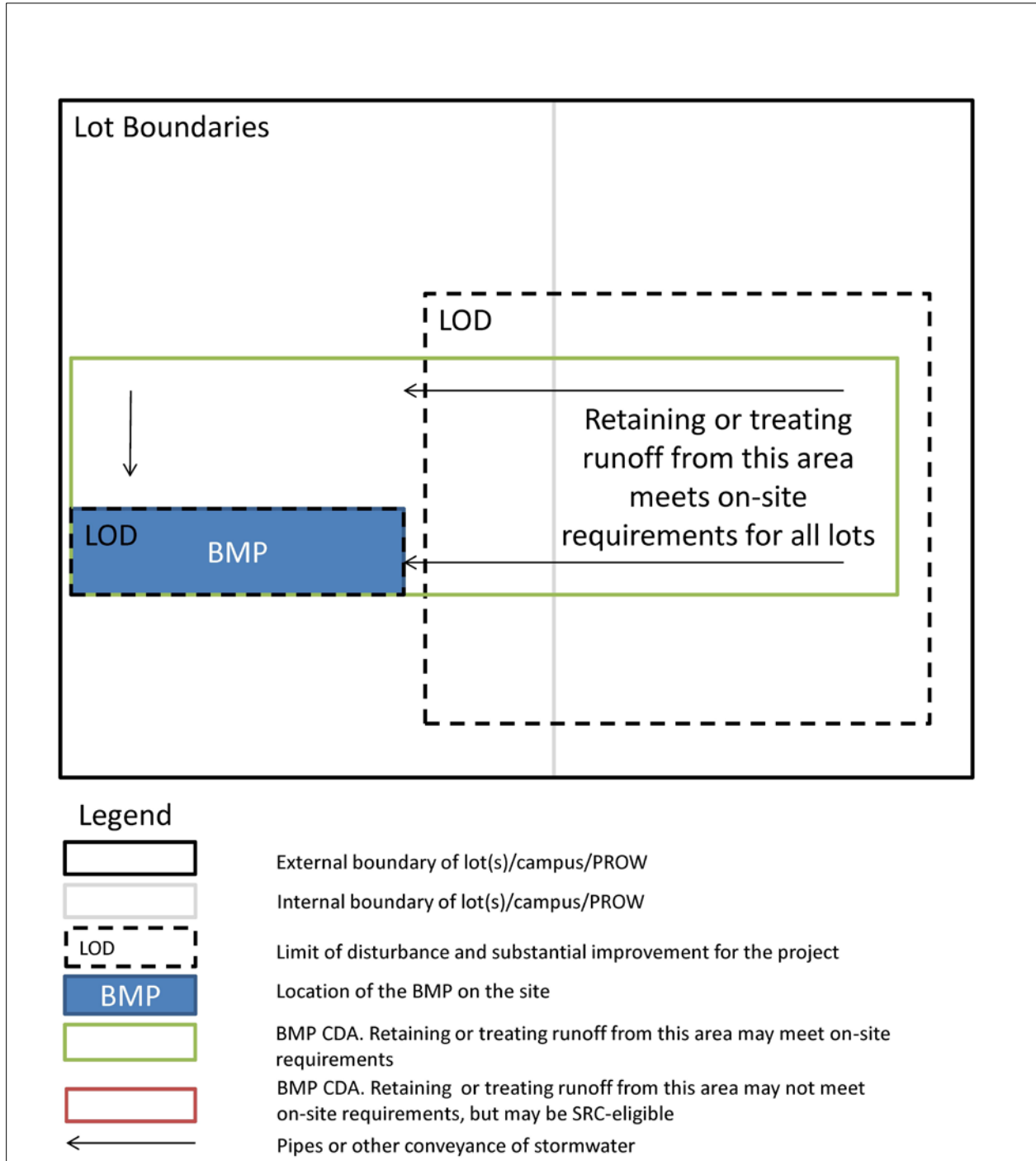
Figure W.18 Many lots: BMP and CDA are on an adjacent, undisturbed lot.

Figure W.19 shows that if a BMP is installed outside the LOD for a project on one of the disturbed lots, any retention or treatment volume achieved by the BMP may meet on-site requirements if the BMP's surface is considered part of the LOD. Performance requirements are calculated for this additional LOD. If the applicant wishes to install the BMPs voluntarily without increasing the LOD, refer to Figure W.17.



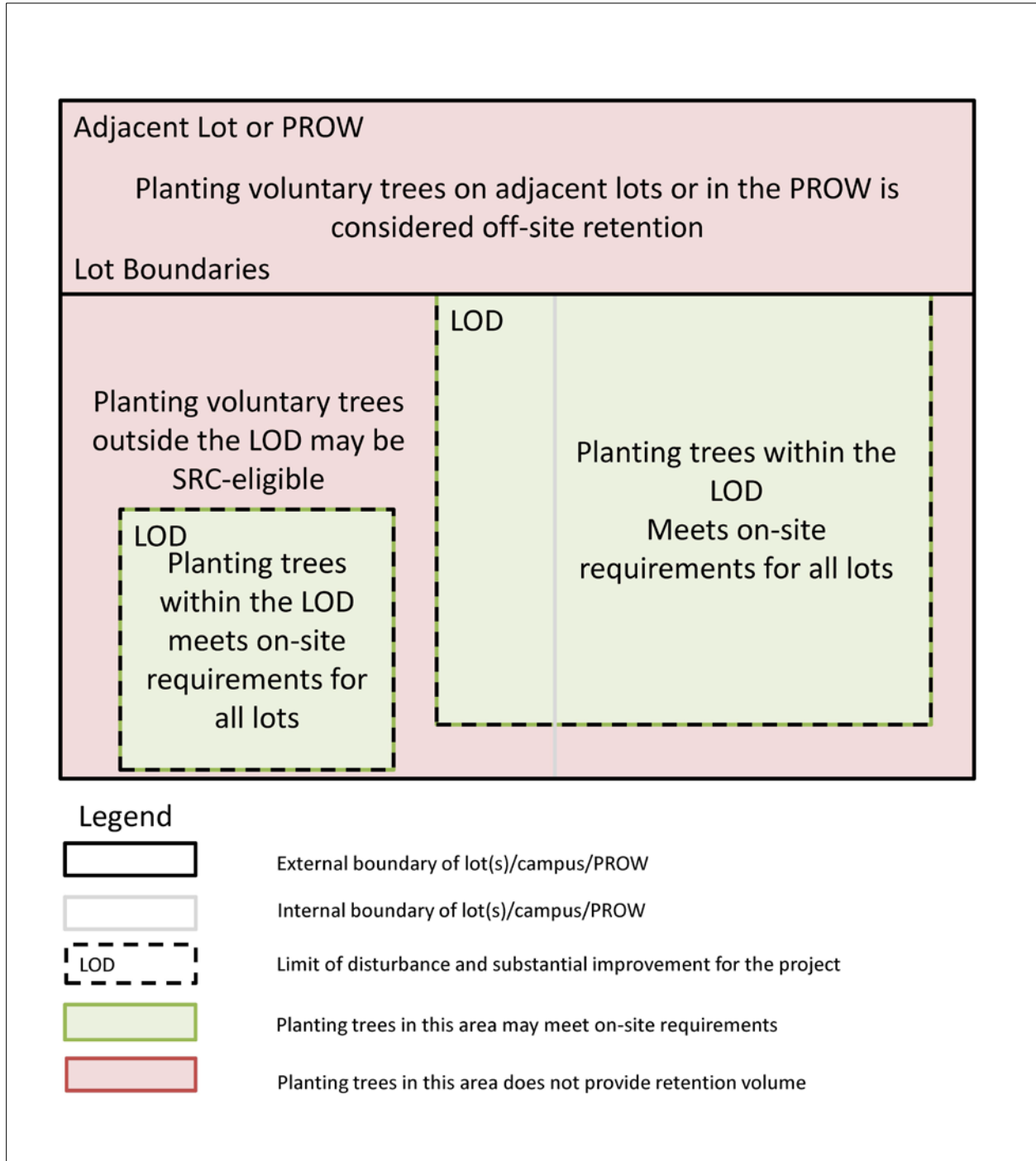
**Figure W.19 Many lots: BMP and CDA are outside primary LOD.**

Figure W.20 shows that if a BMP is installed outside the LOD for a project, but receives runoff from within the LOD, DOEE will also consider the surface of the BMP to be part of the LOD. Performance requirements are calculated for this additional LOD. Any retention or treatment achieved by the BMP may meet on-site requirements.



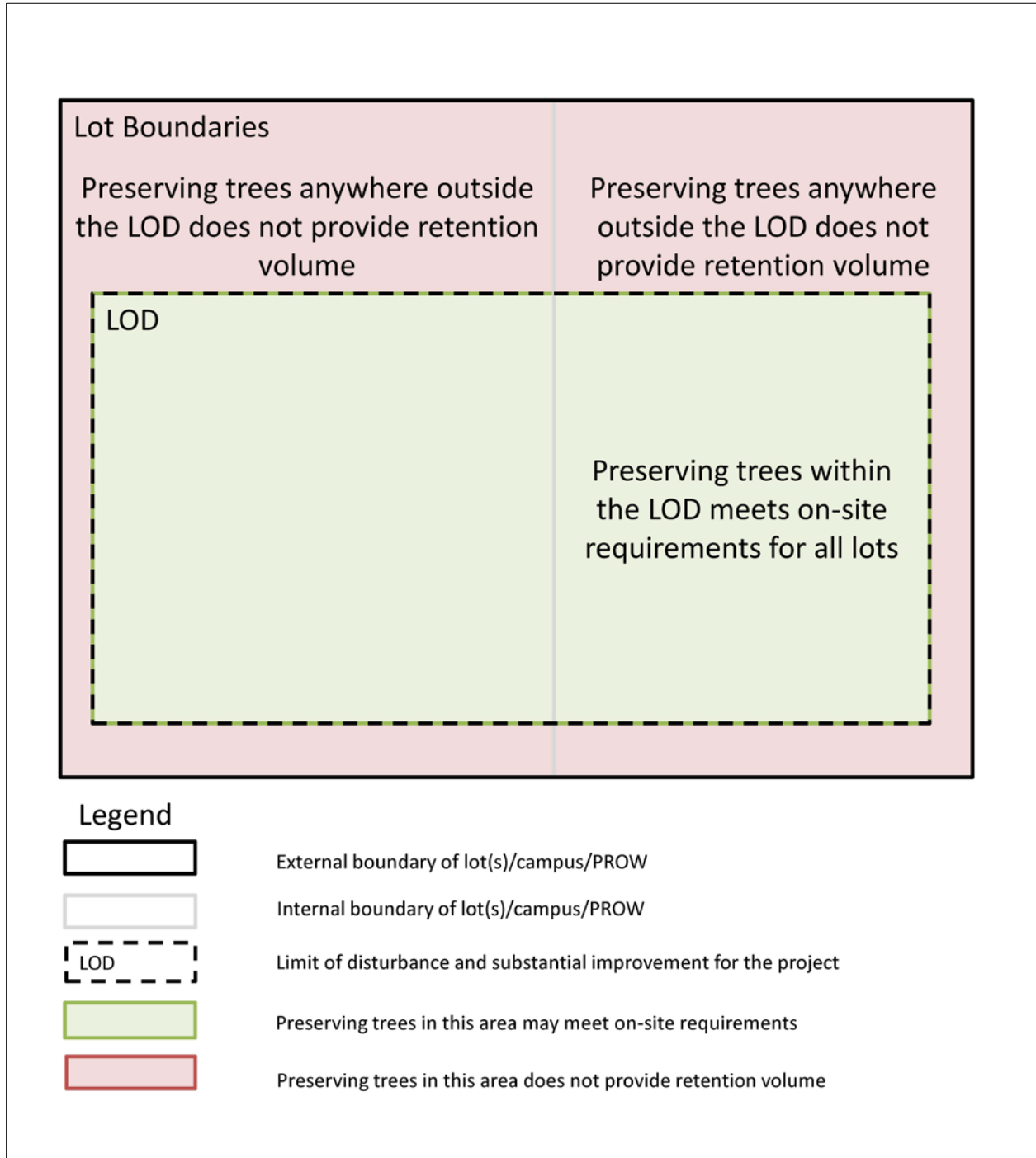
**Figure W.20 Many lots: BMP is outside primary LOD; CDA includes area within primary LOD.**

Figure W.21 shows that planting trees inside the LOD may meet on-site requirements. Land disturbance associated with tree planting is considered part of the LOD for the project. Alternatively, trees may be planted in these areas voluntarily to generate SRCs without increasing the LOD, but these trees will not meet on-site requirements.



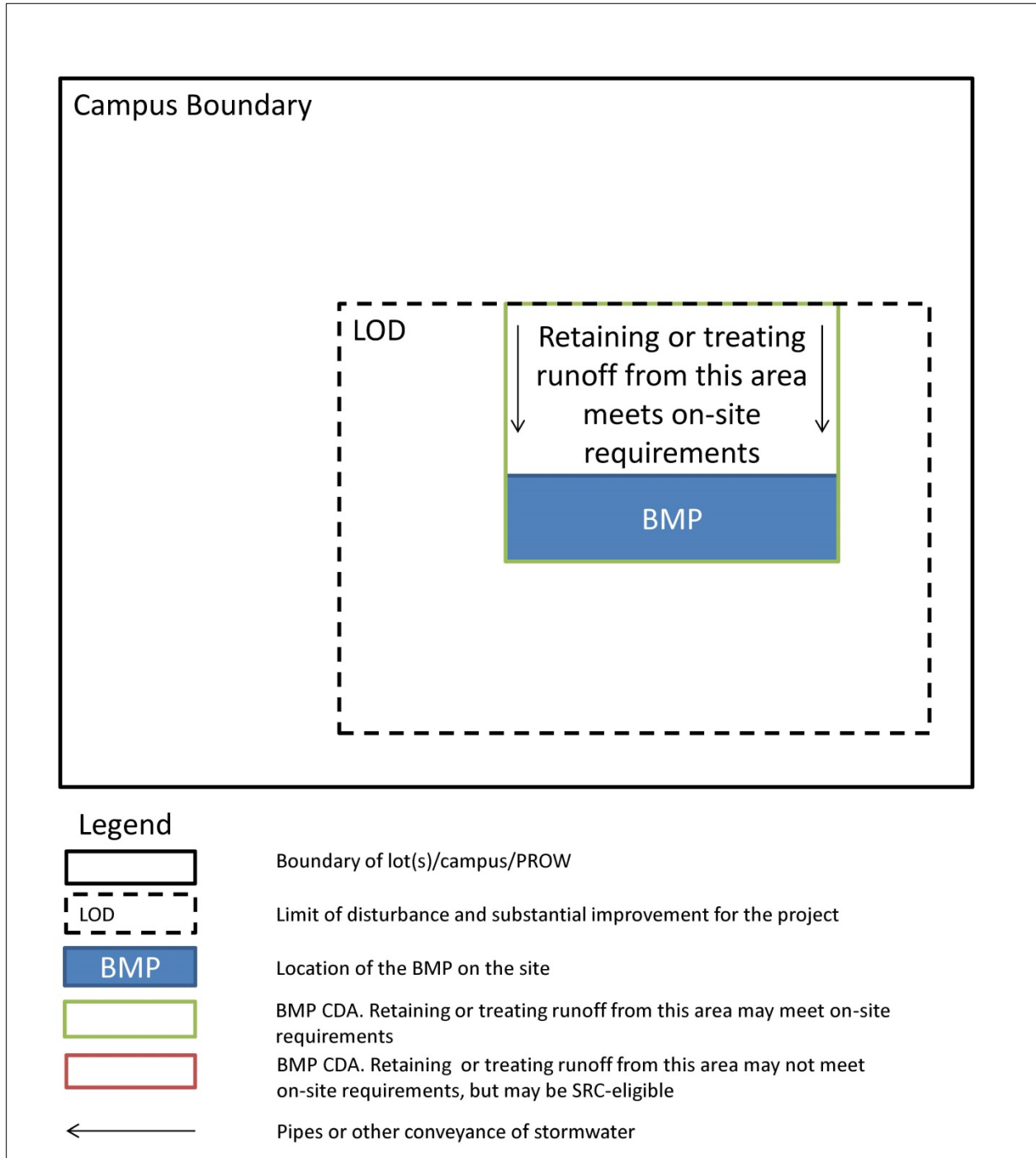
**Figure W.21 Many lots: Tree planting.**

Figure W.22 shows that preserving trees anywhere within the LOD may meet on-site requirements. Generally, preserving trees outside the LOD does not provide a retention volume.



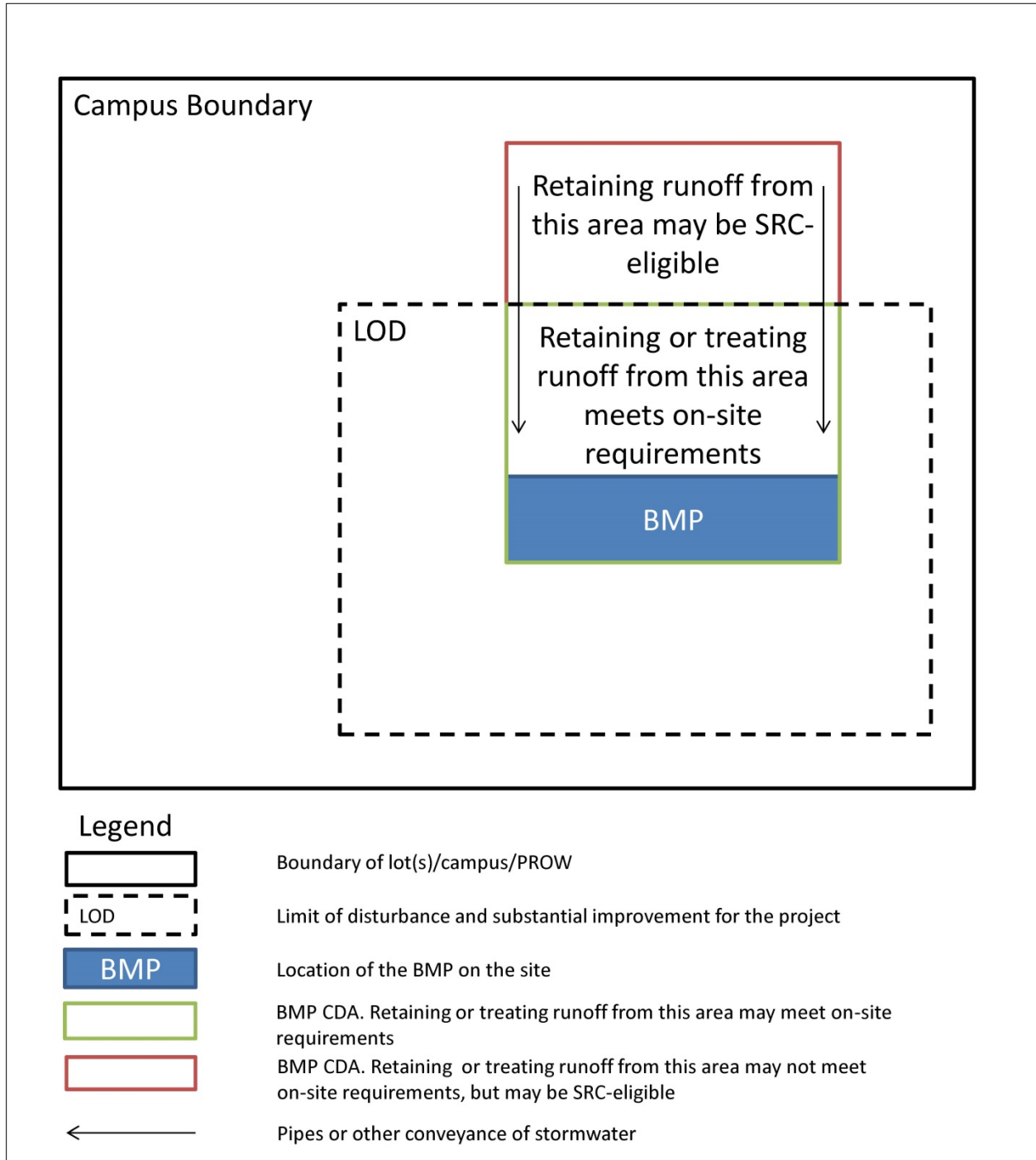
**Figure W.22 Many lots: Tree preservation.**

Figure W.23 shows that if a BMP and its entire CDA are within the LOD, any retention or treatment volume achieved by the BMP may meet on-site requirements.



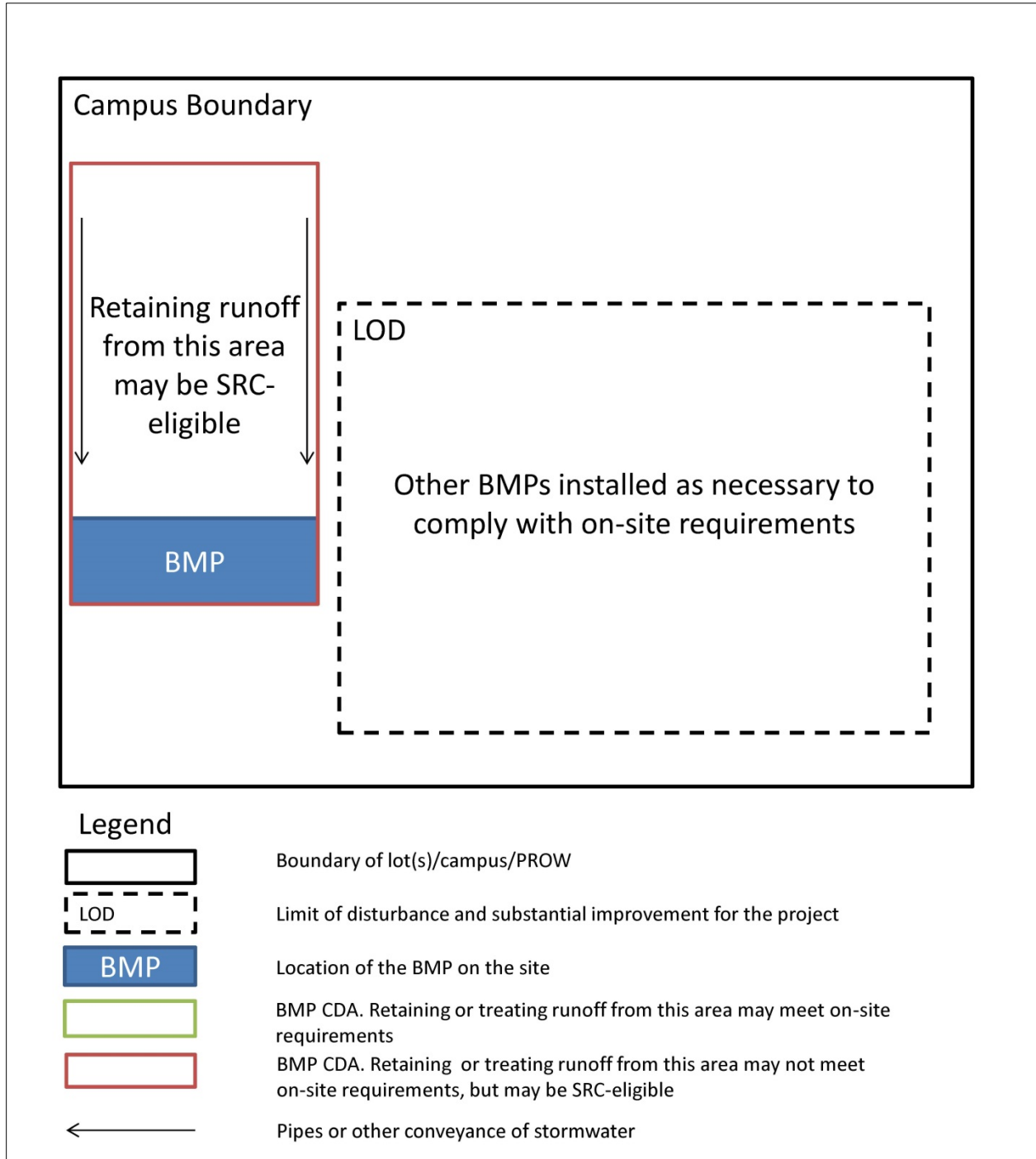
**Figure W.23 Campus: BMP and CDA are entirely within the LOD.**

Figure W.24 shows that if a BMP's CDA includes any area from outside the LOD, any retention or treatment volume achieved by the BMP may partially meet on-site requirements.



**Figure W.24 Campus: CDA is partially outside the LOD.**

Figure W.25 shows that if a BMP is installed outside the LOD, and receives no runoff from the LOD, it may be considered voluntary and generate SRCs. However, no retention or treatment volume achieved may meet on-site requirements. If the applicant wishes to use these BMPs to meet on-site requirements, refer to Figure W.29.



**Figure W.25 Campus: BMP and CDA are entirely outside the LOD.**



Figure W.26 shows that planting trees anywhere within the LOD may meet on-site requirements. Land disturbance associated with tree planting is considered part of the LOD for the project. Alternatively, trees may be planted in elsewhere on the campus, outside the LOD, to voluntarily generate SRCs without increasing the LOD, but these trees will not meet on-site requirements.

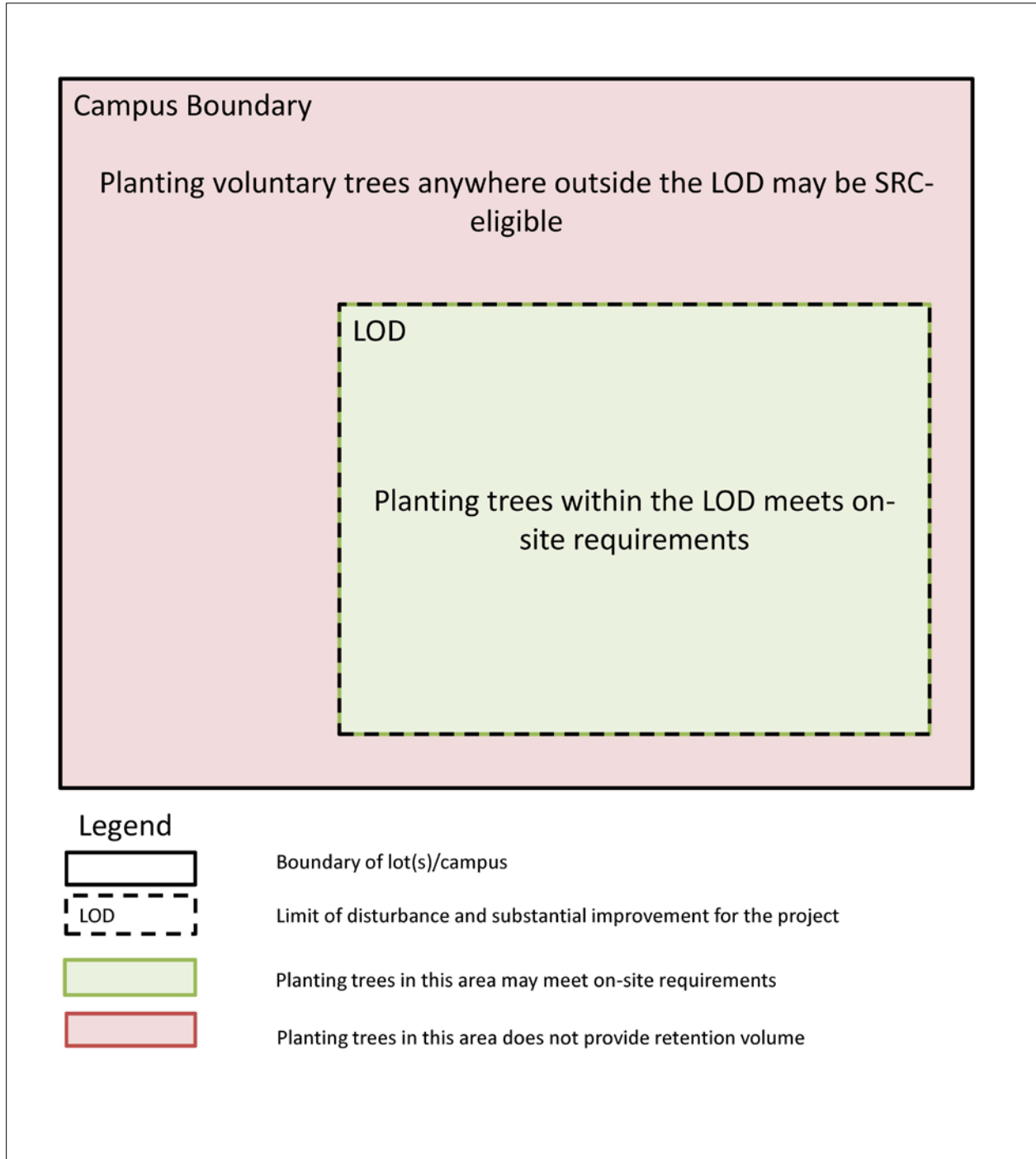
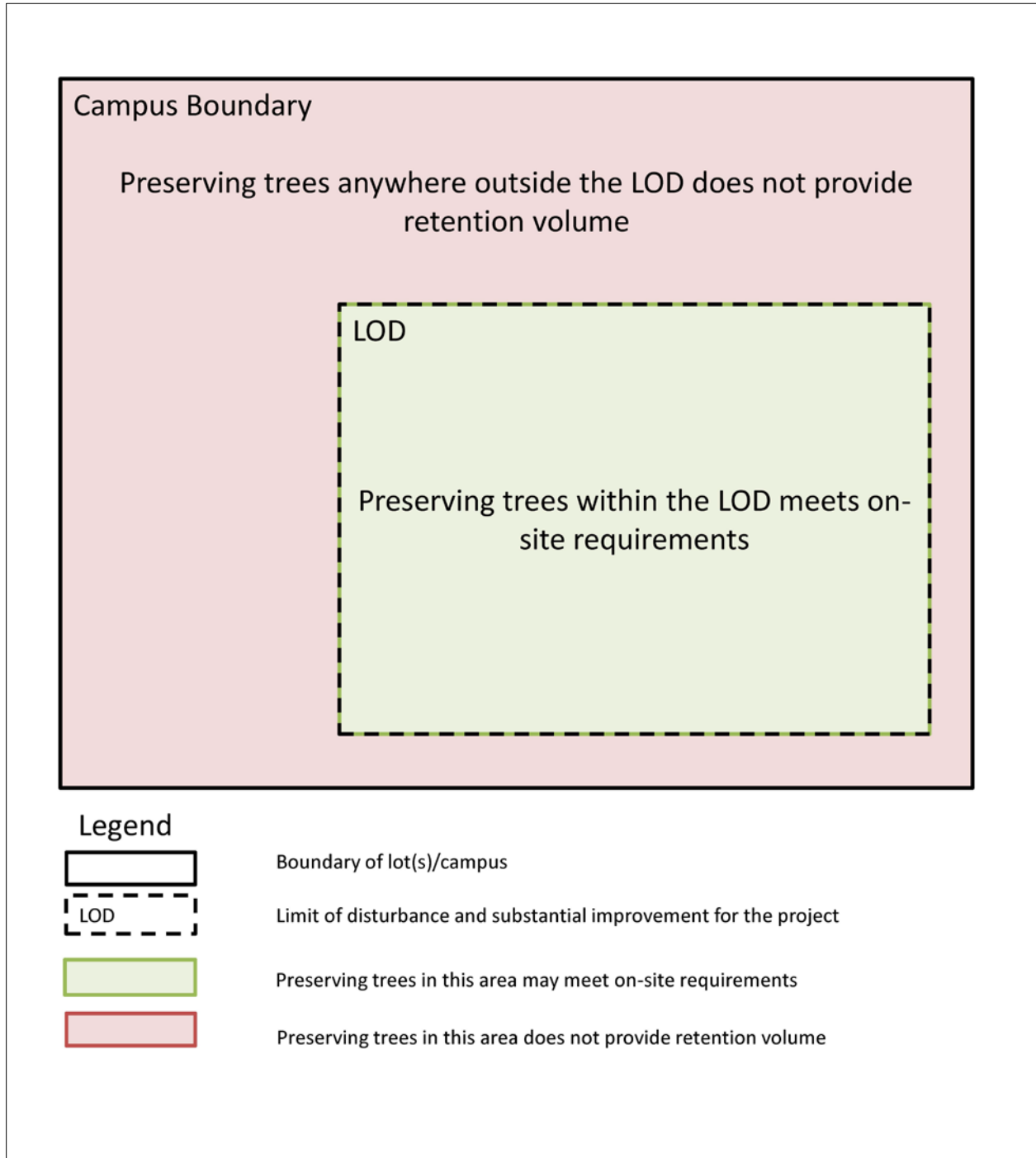


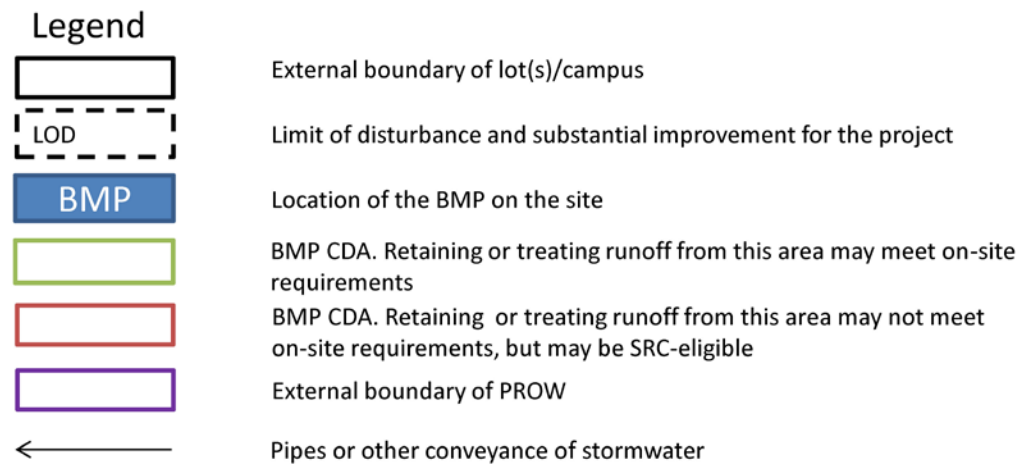
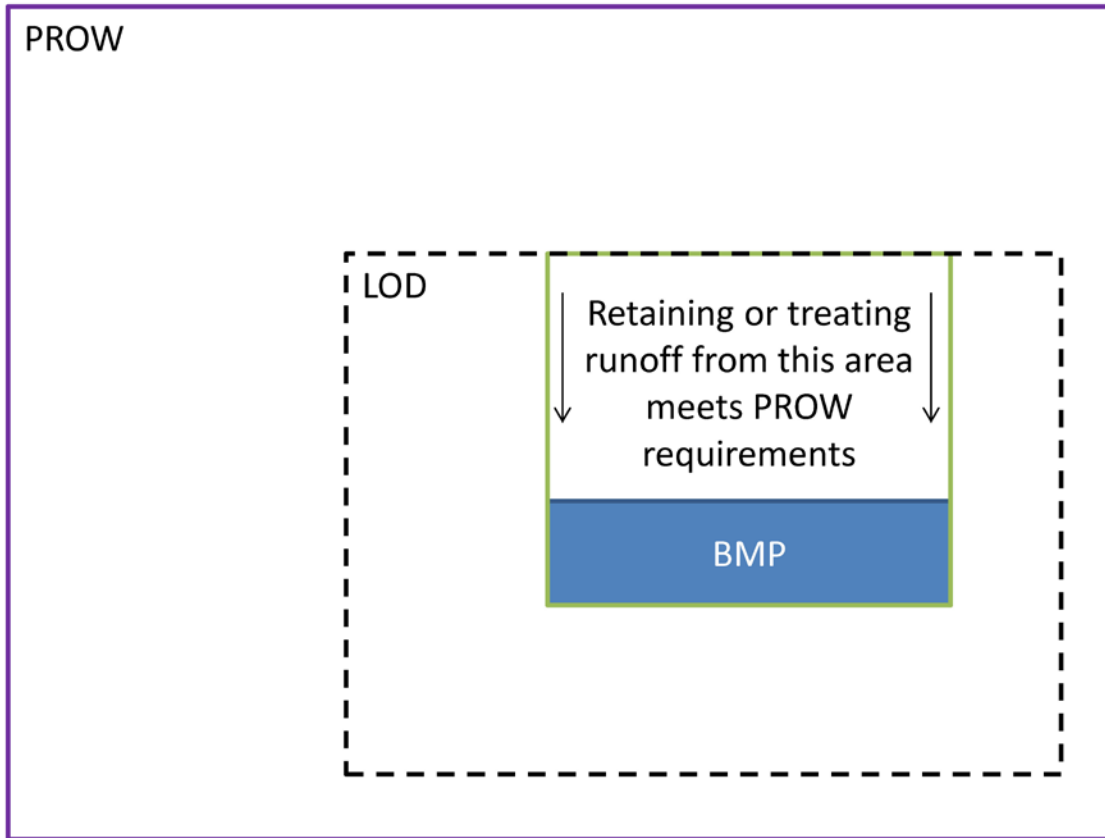
Figure W.26 Campus: Tree planting.

Figure W.27 shows that preserving trees anywhere within the LOD may meet on-site requirements. Generally, preserving trees outside the LOD does not provide a retention volume.



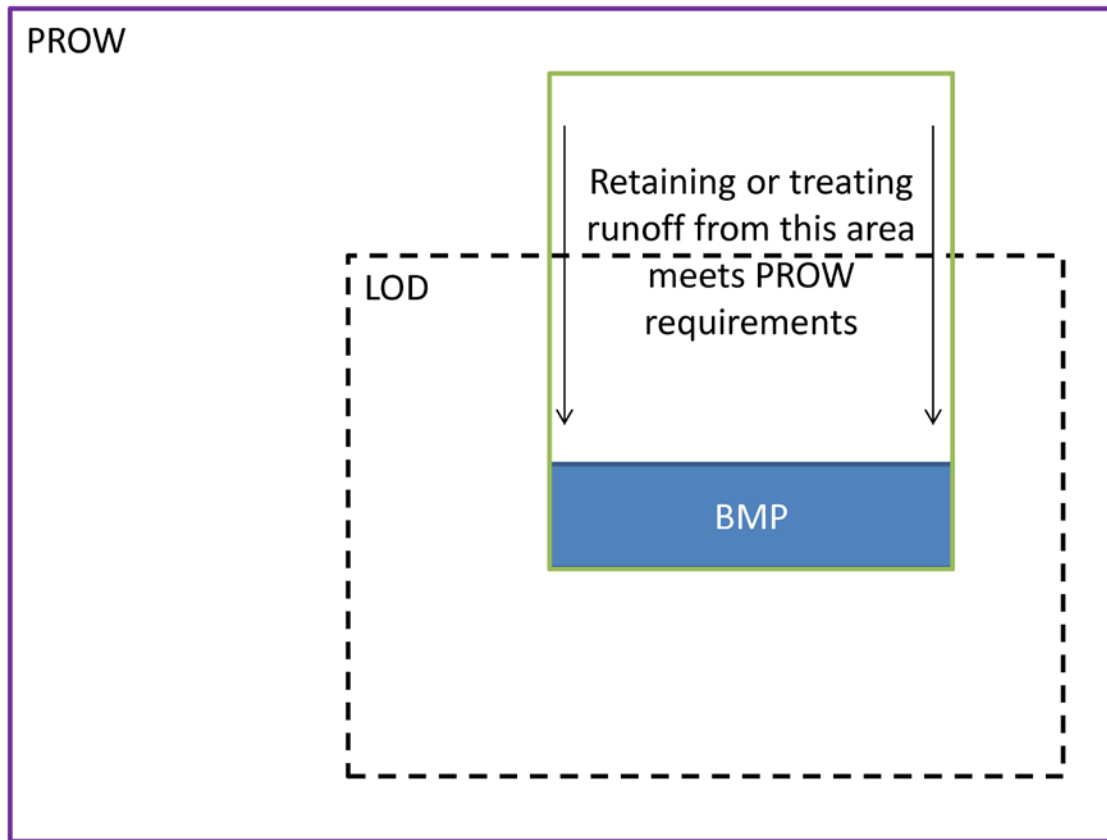
**Figure W.27 Campus: Tree preservation.**


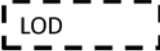





Figure W.28 shows that if a BMP and its entire CDA are within the LOD, any retention or treatment volume achieved by the BMP may meet PROW requirements.



**Figure W.28 PROW: BMP and CDA are entirely within the LOD.**

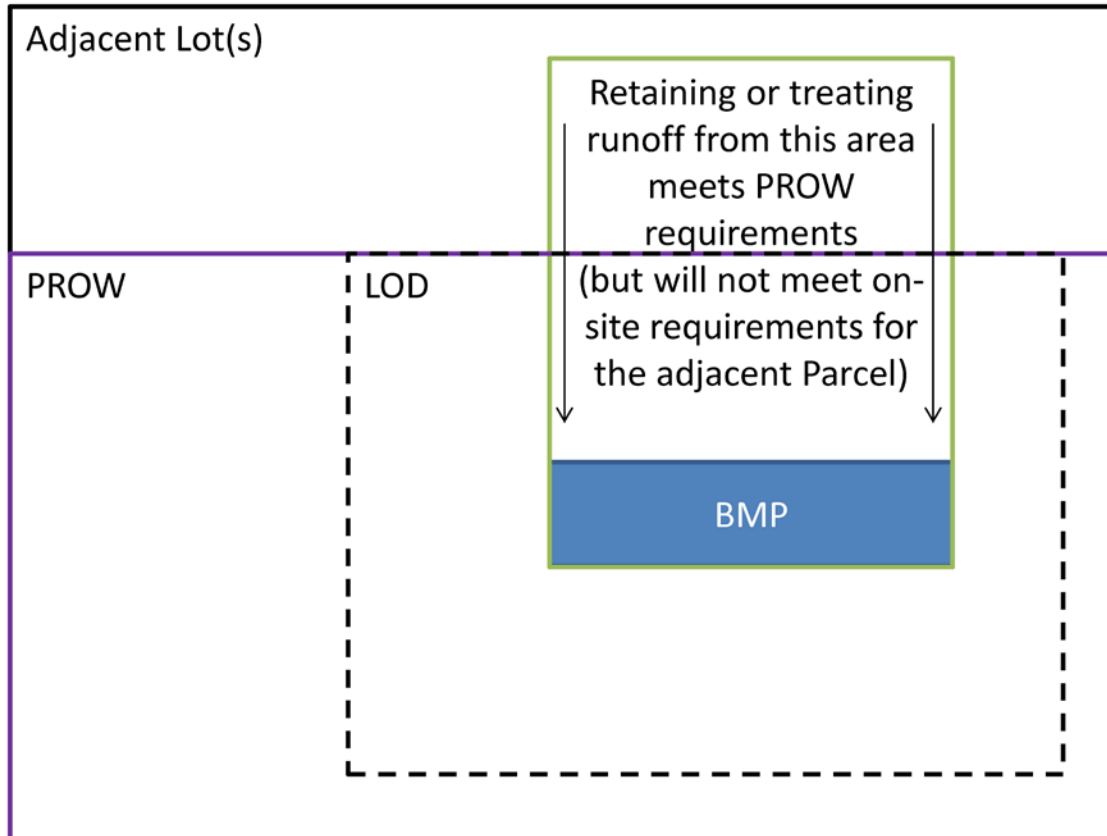
Figure W.29 shows that if the BMP is within the LOD and its entire CDA is within the PROW, any retention or treatment volume achieved by the BMP may meet PROW requirements.


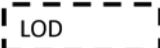







Legend	
	External boundary of lot(s)/campus
	Limit of disturbance and substantial improvement for the project
	Location of the BMP on the site
	BMP CDA. Retaining or treating runoff from this area may meet on-site requirements
	BMP CDA. Retaining or treating runoff from this area may not meet on-site requirements, but may be SRC-eligible
	External boundary of PROW
	Pipes or other conveyance of stormwater

**Figure W.29 PROW: CDA is partially outside the LOD, but within the PROW.**

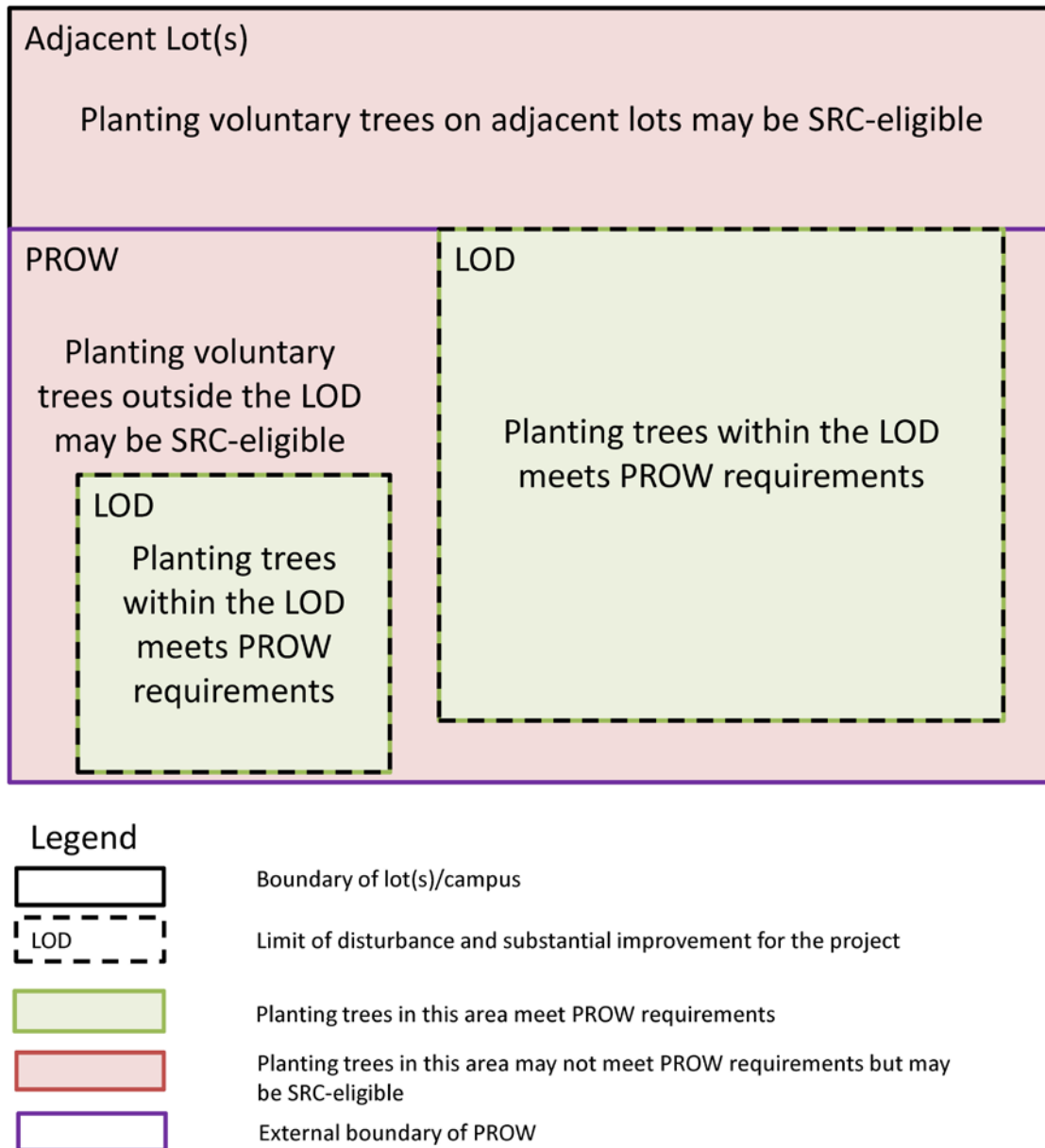
Figure W.30 shows that if the BMP is within the LOD and its CDA includes an adjacent lot, any retention or treatment volume achieved by the BMP may meet PROW requirements. Retention of the 1.2-inch storm from the PROW must be achieved prior to receiving runoff from adjacent lots. BMPs located in the PROW cannot meet on-site requirements for adjacent lots, even if the CDA includes adjacent lot.



- Legend**
-  External boundary of lot(s)/campus
  -  LOD
  -  BMP
  -  BMP CDA. Retaining or treating runoff from this area may meet on-site requirements
  -  BMP CDA. Retaining or treating runoff from this area may not meet on-site requirements, but may be SRC-eligible
  -  External boundary of PROW
  -  Pipes or other conveyance of stormwater

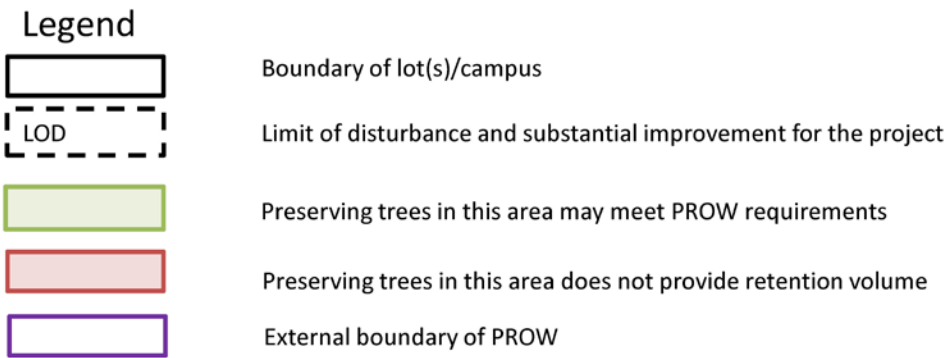
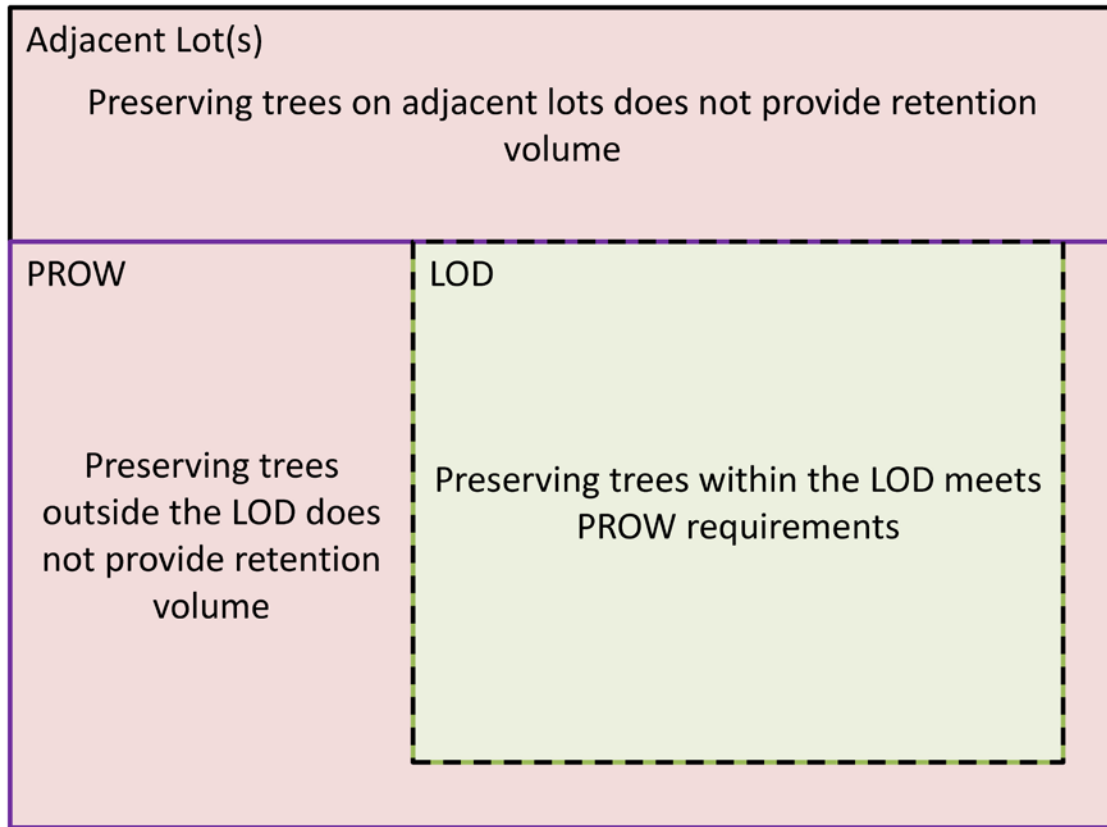
**Figure W.30 PROW: CDA is partially in an adjacent lot.**

Figure W.31 shows that planting trees within the LOD may meet PROW requirements. Land disturbance associated with tree planting is considered part of the LOD for the project. Alternatively, trees may be planted in these areas voluntarily to generate SRCs without increasing the LOD.



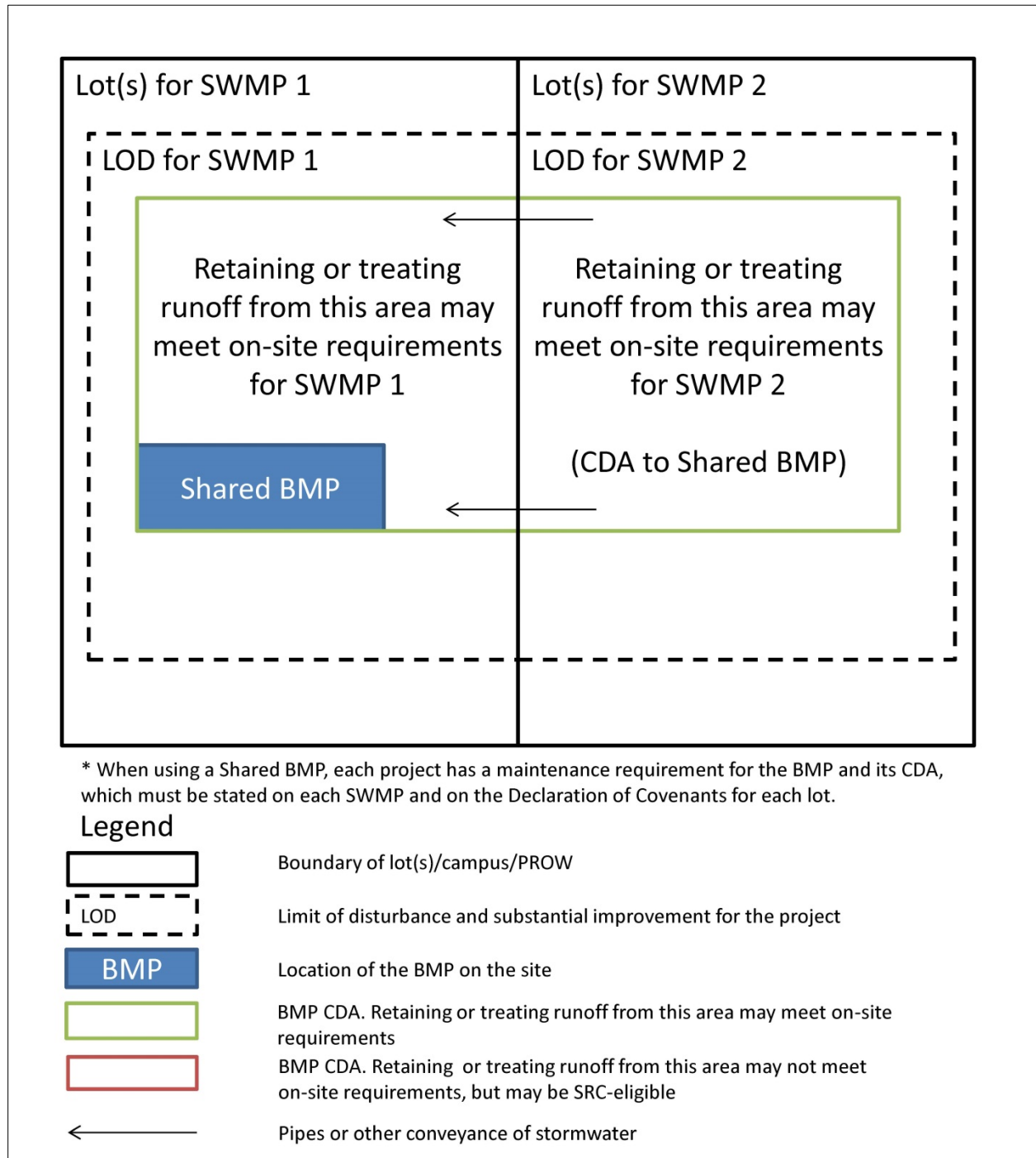
**Figure W.31 PROW: Tree planting.**

Figure W.32 shows that preserving trees within the LOD may meet PROW requirements. Generally, preserving trees outside the LOD does not provide a retention volume.



**Figure W.32 PROW: Tree preservation.**

Figure W.33 shows how the retention or treatment achieved by a shared BMP may meet on-site requirements for many SWMPs.



**Figure W.33 Shared BMPs.**



# Appendix X Resources

The following documents provide more detailed information on many aspects of best management practice (BMP) design than is found in this guidebook. These resources may be useful for those looking to develop greater understanding of individual BMPs or stormwater design in general. Recommendations in these resources may be used to inform BMP designs; however, where conflicts occur between these resources and this guidebook, the requirements of this guidebook prevail.

American Association of State Highway and Transportation Officials (AASHTO). 1993. AASHTO Guide for Design of Pavement Structures, 4th Edition with 1998 Supplement. Washington, D.C.

Arendt, R. G. 1996. Conservation design for subdivisions. A practical guide to creating open space networks. Washington, DC: Island Press. 184 p.

ASTM E2400 / E2400M-06(2015)e1, Standard Guide for Selection, Installation, and Maintenance of Plants for Green Roof Systems, ASTM International, West Conshohocken, PA, 2015, [www.astm.org](http://www.astm.org) Brown, M.L., and R.G. Brown. 1984. Herbaceous Plants of Maryland. Port City Press, Baltimore, MD.

Brown, Melvin L., and R.G. Brown. 1984. Woody Plants of Maryland. Port City Press, Baltimore, MD.

City Press, Baltimore, MD. Cabell Brand Center. 2009. Virginia Rainwater Harvesting Manual, Version 2.0. Salem, VA.  
<https://www.radford.edu/content/dam/departments/administrative/Sustainability/Documents/Rainwater-Manual.pdf>

Cappiella, K., T. Schueler, and T. Wright. 2005. Urban Watershed Forestry Manual. Part 1: Methods for Increasing Forest Cover in a Watershed. NA-TP-04-05. USDA Forest Service, Northeastern Area State and Private Forestry. Newtown Square, PA.

Cappiella, K., T. Schueler and T. Wright. 2006. Urban Watershed Forestry Manual: Part 2: Conserving and Planting Trees at Development Sites. USDA Forest Service. Center for Watershed Protection. Ellicott City, MD.

Center for Watershed Protection. 1998. Better site design: a handbook for changing development rules in your community. Ellicott City, MD. 174 p.

Chollak, T. and P. Rosenfeld. 1998. Guidelines for Landscaping with Compost-Amended Soils. City of Redmond Public Works. Redmond, WA. Available online at:  
<http://www.redmond.gov/common/pages/UserFile.aspx?fileId=14766>

- Claytor, R. and T. Schueler. 1996. Design of Stormwater Filtering Systems. Chesapeake Research Consortium and the Center for Watershed Protection. Ellicott City, MD.  
<https://owl.cwp.org/>
- Das, Braja M. 1990. Principle of Geotechnical Engineering Second Edition. PWS-KENT Publishing Company. Boston, MA.
- District of Columbia Department of Transportation (DDOT). Design and Engineering Manual 2017. <https://ddot.dc.gov/publication/ddot-design-and-engineering-manual-2017>
- District of Columbia Department of Transportation (DDOT). Green Infrastructure Standards 2014. <https://ddot.dc.gov/publication/ddot-green-infrastructure-standards-2014>
- District of Columbia Department of Transportation (DDOT). Public Realm Design Manual 2011. <https://ddot.dc.gov/PublicRealmDesignManual>
- District of Columbia Water and Sewer Authority. 2009. D.C. Project Design Manual Volume 3 Infrastructure Design. Washington DC.  
<https://www.dewater.com/sites/default/files/Project%20Design%20Manual%20Volume%203%20Infrastructure%20Design.pdf>
- Doherty, K.; Bloniarz, D.; Ryan, H. 2003. Positively the pits: successful strategies for sustainable streetscapes. Tree Care Industry 14(11): 34-42.  
<http://www.umass.edu/urbantree/publications/pits.pdf> (Accessed 2006).
- Dunnett, N. and N. Kingsbury. 2004. Planting Green Roofs and Living Walls. Timber Press. Portland, Oregon.
- Environmental Services City of Portland, 2008, Green Streets Construction Guide. Portland, OR.  
<https://www.portlandoregon.gov/bes/article/228860>
- Gilman, E. F. 1997. Trees for urban and suburban landscapes. Albany, NY: Delmar Publishers.
- Hairston-Strang, A. 2005. Riparian forest buffer design and maintenance. Annapolis: Maryland Department of Natural Resources. <http://dnr.maryland.gov/forests/Pages/publications.aspx>
- Hathaway, J.M. and Hunt, W.F. 2006. Level Spreaders: Overview, Design, and Maintenance. Urban Waterways Design Series. North Carolina Cooperative Extension Service. Raleigh, NC. Available online: <http://chesapeakestormwater.net/wp-content/uploads/downloads/2012/01/LevelSpreaders2006.pdf>
- Hightshoe, G.L., 1988. Native Trees, Shrubs, and Vines for Urban and Rural America. Van Nostrand Reinhold, New York, NY.
- Hirschman, D., L. Woodworth and S. Drescher. 2009. Technical Report: Stormwater BMPs in Virginia's James River Basin: An Assessment of Field Conditions & Programs. Center for Watershed Protection. Ellicott City, MD.

- Hunt, W., M. Burchell, J. Wright and K. Bass. 2007. "Stormwater Wetland Design Update: Zones, Vegetation, Soil and Outlet Guidance." Urban Waterways. North Carolina State Cooperative Extension Service. Raleigh, NC.
- Hunt, W.F. III and W.G. Lord. 2006. "Bioretention Performance, Design, Construction, and Maintenance." North Carolina Cooperative Extension Service Bulletin. Urban Waterways Series. AG-588-5. North Carolina State University. Raleigh, NC.
- Jackson, N. 2007. Design, Construction and Maintenance Guide for Porous Asphalt Pavements. National Asphalt Pavement Association. Information Series 131. Lanham, MD.  
<http://www.asphaltpavement.org/index.php> .
- Low Impact Development Center. 2003. Guideline for Soil Amendments.
- Luckett, K. 2009. Green Roof Construction and Maintenance. McGraw-Hill Companies, Inc.
- Maryland—National Capital Park & Planning Commission. 1998. Native Plants of Prince George's County, Maryland 1997–1998. Maryland—National Capital Park & Planning Commission, Riverdale, MD.
- New Jersey Corporation for Advanced Technology (NJCAT) Technology Verification Program and Testing Protocols available at: <http://www.njcat.org/> and <http://www.njstormwater.org/treatment.html>
- New Jersey Department of Environmental Protection (NJDEP), 2009a. Protocol for Manufactured Filtration Devices for Total Suspended Solids Based on Laboratory Analysis Dated August 5, 2009, Revised December 15, 2009. New Jersey Department of Environmental Protection. Available at: [http://www.njstormwater.org/pdf/filter\\_protocol\\_12-15-09.pdf](http://www.njstormwater.org/pdf/filter_protocol_12-15-09.pdf)
- NJDEP, 2009b. Protocol for Total Suspended Solids Removal Based on Field Testing Amendments to TARP Protocol Dated August 5, 2009, Revised December 15, 2009. New Jersey Department of Environmental Protection. Available at: [http://www.njstormwater.org/pdf/field\\_protocol\\_12\\_15\\_09.pdf](http://www.njstormwater.org/pdf/field_protocol_12_15_09.pdf)
- NJDEP 2011 Transition for Manufactured Treatment Devices, July 15, 2011. Available at: <http://www.njstormwater.org/pdf/mtd-certification-process-7-13.pdf>
- North Carolina Division of Water Quality (NCDWQ). 2010. Level Spreader-Vegetated Filter Strip System. Stormwater Best Practices Manual. Raleigh, NC.  
[http://portal.ncdenr.org/c/document\\_library/get\\_file?uuid=5d698f00-caaa-4f64-ac1f-d1561b4fd53d&groupId=38364](http://portal.ncdenr.org/c/document_library/get_file?uuid=5d698f00-caaa-4f64-ac1f-d1561b4fd53d&groupId=38364)
- Palone, R. S.; Todd, A. H., eds. 1998. Chesapeake Bay riparian handbook: a guide for establishing and maintaining riparian forest buffers. NA-TP-02-97. Radnor, PA: USDA Forest Service, Northeastern Area State and Private Forestry.

- Pennsylvania State University. 1999. A guide to preserving trees in development projects. University Park, PA: Penn State College of Agricultural Sciences, Cooperative Extension. 27 p.
- “Precipitation-Frequency Atlas of the United States” NOAA Atlas 14, Volume 2, Version 3.0, G. M. Bonnin, D. Martin, B. Lin, T. Parzybok, M. Yekta, and D. Riley, NOAA, National Weather Service, Silver Spring, Maryland, 2006. <https://hdsc.nws.noaa.gov/hdsc/pfds/>
- Pitt, R., 1994, Small Storm Hydrology. University of Alabama - Birmingham. Unpublished manuscript. Presented at design of stormwater quality management practices. Madison, WI, May 17-19 1994.
- Reed, P.B. Jr., 1988. National List of Species That Occur in Wetlands: Northeast. U.S. Fish and Wildlife Service, St. Petersburg, FL.
- Roa-Espinosa. 2006. An Introduction to Soil Compaction and the Subsoiling Practice. Technical Note. Dane County Land Conservation Department. Madison, Wisconsin.
- Schueler, Thomas R. 1987. Controlling Urban Runoff: A Practice Manual for Planning and Designing Urban BMPs. Department of Environmental Programs. Metropolitan Washington Council of Governments. Prepared for: Washington Metropolitan Water Resources Planning Board. Washington, DC.
- Schueler, Thomas R. 1992. Design of Stormwater Wetland Systems. Metropolitan Washington Council of Governments. Washington, DC.
- Schueler, T. R. 1995. Site planning for urban stream protection. Ellicott City, MD: Center for Watershed Protection. 232 p.
- Schueler, T.; Brown, K. 2004. Urban stream repair practices. Version 1.0. Manual 4 of the Urban Subwatershed Restoration Manual Series. Ellicott City, MD: Center for Watershed Protection.
- Smith, D. 2006. Permeable Interlocking Concrete Pavement-selection design, construction and maintenance. Third Edition. Interlocking Concrete Pavement Institute. Herndon, VA.
- Snodgrass, E. and L. Snodgrass. 2006. Green Roof Plants: a resource and planting guide. Timber Press. Portland, OR.
- Sturm, Paul, Chris Swann, and Deb Caraco. 2000. Impacts of Urbanization on Receiving Waters. Center for Watershed Protection. Ellicott City, MD.
- U.S. Department of Agriculture (USDA). 1954. Handbook of channel design for soil and water conservation. SCS-TP-61. Washington, DC. Available online: [https://www.nrcs.usda.gov/Internet/FSE\\_DOCUMENTS/stelprdb1044529.pdf](https://www.nrcs.usda.gov/Internet/FSE_DOCUMENTS/stelprdb1044529.pdf)
- U.S. Fish and Wildlife Service, 2009. Native Plants for Wildlife Habitat and Conservation Landscaping: Chesapeake Bay Watershed.

<https://www.fws.gov/Chesapeakebay/pdf/NativePlantsforWildlifeHabitatandConservationLandscaping.pdf>

U.S. Fish and Wildlife Service, 2001. Native Plants for Wildlife Habitat and Conservation Landscaping, Maryland: Coastal Plain.

<https://www.fws.gov/chesapeakebay/bayscapes/bsresources/bs-nativeguides.html>

U.S. Fish and Wildlife Service, 2001. Native Plants for Wildlife Habitat and Conservation Landscaping, Maryland: Piedmont Region.

<https://www.fws.gov/chesapeakebay/bayscapes/bsresources/bs-nativeguides.html>

Virginia Department of Conservation and Recreation (VA DCR). 1999. Virginia Stormwater Management Handbook, first edition.

"Washington D.C. Recommended." NPIN: Recommended Native Plants. The University of Texas at Austin, Lady Bird Johnson Wildflower Center, n.d. Web. 11 July 2013.

<https://www.wildflower.org/collections/collection.php?collection=DC> .

Weiler, S. and K. Scholz-Barth. 2009. Green Roof Systems: A Guide to the Planning, Design, and Construction of Landscapes over Structure. Wiley Press. New York, NY.



# Appendix Y Definitions

**Advanced Design (AD)** – Detailed design for an area of a project described explicitly in the following:

- (a) Stage Two (2) planned unit development (PUD) application to the District of Columbia Zoning Commission;
- (b) Application for design review under the Capitol Gateway Overlay District to the District Zoning Commission; and
- (c) Final design submission to the National Capital Planning Commission (NCPC).

**Affordable Housing** – A single-family or two-family house that is built to be offered for sale for residential occupancy below market value and is made available to, and affordable to, a household whose income is equal to, or less than, eighty percent (80%) of the Area Median Income calculation provided by the United States Department of Housing and Urban Development.

**Anacostia Waterfront Development Zone (AWDZ)** - the following areas of the District of Columbia, as delineated on a map in DOEE’s Stormwater Management Guidebook (Figure 2.1):

- (a) Interstate 395 and all rights-of-way of Interstate 395, within the District, except for the portion of Interstate 395 that is north of E Street, S.W., or S.E.;
- (b) All land between that portion of Interstate 395 that is south of E Street, S.W., or S.E., and the Anacostia River or Washington Channel;
- (c) All land between that portion of Interstate 695, and all rights of way, that are south of E Street, S.W. or S.E., and the Anacostia River;
- (d) The portion of Interstate 295 that is north of the Anacostia River, within the District, and all rights-of-way of that portion of Interstate 295;
- (e) All land between that portion of Interstate 295 that is north of the Anacostia River and the Anacostia River;
- (f) The portions of:
  - ◆ The Anacostia Freeway that is north or east of the intersection of the Anacostia Freeway and Defense Boulevard and all rights-of-way of that portion of the Anacostia Freeway;
  - ◆ Kenilworth Avenue that extend to the northeast from the Anacostia Freeway to Eastern Ave; and
  - ◆ Interstate 295, including its rights-of-way, that is east of the Anacostia River and that extends to the southwest from the Anacostia Freeway to Defense Boulevard.

- (g) All land between those portions of the Anacostia Freeway, Kenilworth Avenue, and Interstate 295 described in (f) and the Anacostia River;
- (h) All land that is adjacent to the Anacostia River and designated as parks, recreation, and open space on the District of Columbia Generalized Land Use Map, dated January 2002, except for the land that is:
  - ◆ North of New York Avenue, N.E.;
  - ◆ East of the Anacostia Freeway, including rights-of-way of the Anacostia Freeway;
  - ◆ East of the portion of Kenilworth Avenue that extends to the northeast from the Anacostia Freeway to Eastern Avenue;
  - ◆ East of the portion of Interstate 295, including its rights-of-way, that is east of the Anacostia River and that extends to the southwest from the Anacostia Freeway to Defense Boulevard, but excluding the portion of 295 and its rights-of-way that go to the northwest across the Anacostia River;
  - ◆ Contiguous to that portion of the Suitland Parkway that is south of Martin Luther King, Jr. Avenue; or
  - ◆ South of a line drawn along, and as a continuation both east and west of the center line of the portion of Defense Boulevard between Brookley Avenue, S.W., and Mitscher Road, S.W.;
- (i) All land, excluding Eastern High School, that is:
  - ◆ Adjacent to the land described in (h);
  - ◆ West of the Anacostia River; and
  - ◆ Designated as a local public facility on the District of Columbia Generalized Land Use Map, dated January 2002;
- (j) All land that is:
  - ◆ South or east of that portion of Potomac Avenue, S.E., between Interstate 295 and 19th Street, S.E.; and
  - ◆ West or north of the Anacostia River;
- (k) The portion of the Anacostia River within the District; and
- (l) The Washington Channel.

**Anacostia Waterfront Development Zone Site (AWDZ site)** – A site within the Anacostia Waterfront Development Zone that undergoes a major regulated project that is publicly owned or publicly financed.

**Animal confinement area** – An area, including a structure, used to stable, kennel, enclose, or otherwise confine animals, not including confinement of a domestic animal on a residential property.

**Applicant** – A person or their agent who applies for approval pursuant to this chapter.



**As-built plan** – A set of architectural, engineering, or site drawings, sometimes including specifications that certify, describe, delineate, or present details of a completed construction project.

**Athletic playing fields** – Compacted land cover and synthetic surfaces that are constructed primarily for use for athletic activities at public parks and schools. Compacted land cover and synthetic surfaces for which athletic activities are not the primary use are not considered athletic playing fields, unless these areas are necessary to support use of an adjacent area that is primarily used for athletic activities. Synthetic surfaces must have a minimum surface permeability of at least 10 inches per hour, in accordance with ASTM F2898 Standard Test Method for Permeability of Synthetic Turf Sports Field Base Stone and Surface System by Non-confined Area Flood Test Method.

**Best management practice (BMP)** – Structural or nonstructural practice that minimizes the impact of stormwater runoff on receiving waterbodies and other environmental resources, especially by reducing runoff volume and the pollutant loads carried in that runoff.

**Buffer** – An area along a stream, river, or other natural feature that provides protection for that feature.

**Building permit** – Authorization for construction activity issued by the District of Columbia Department of Consumer and Regulatory Affairs.

**Clearing** – The removal of trees and brush from the land excluding the ordinary mowing of grass, pruning of trees or other forms of long-term landscape maintenance.

**Combined sewer overflow (CSO)** - The discharge of untreated effluent into a water body as a result of the combined volume of stormwater and sanitary water exceeding the capacity of the combined sewer system and wastewater treatment plant.

**Combined sewer system (CSS)** – Sewer system in which stormwater runoff is conveyed together with sanitary wastewater through sewer lines to a wastewater treatment plant.

**Common plan of development** – Multiple, separate, and distinct land-disturbing, substantial improvement, or other construction activities taking place under, or to further, a single, larger plan, although they may be taking place at different times on different schedules.

**Compacted cover** – An area of land that is functionally permeable, but where permeability is impeded by increased soil bulk density as compared to natural cover, such as through grading, construction, or other activity and will require regular human inputs such as periodic planting, irrigation, mowing, or fertilization. Examples include landscaped planting beds, lawns, or managed turf.

**Conservation area** – An area with a natural cover designation set aside to receive stormwater runoff as part of an impervious surface disconnection practice.

**Construction** – Activity conducted for the following:

- (a) Building, renovation, modification, or razing of a structure; or
- (b) Movement or shaping of earth, sediment, or a natural or built feature.

**Contributing drainage area (CDA)** – Area contributing runoff to a BMP.

**Control measure** – Technique, method, device, or material used to prevent, reduce, or limit discharge.

**Critical area stabilization** – Stabilization of areas highly susceptible to erosion, including down-slopes and side-slopes, through the use of brick bats, straw, erosion control blanket mats, gabions, vegetation, and other control measures.

**Critical Root Zone (CRZ)** – The minimum protection area required to preserve the health and stability of a tree during construction. It is measured as a circular area with a radius (in feet) equal to 1.5 times the trunk diameter (in inches)

**Cut** – An act by which soil or rock is dug into, quarried, uncovered, removed, displaced, or relocated and the conditions resulting from those actions.

**Demolition** – The removal of part or all of a building, structure, or built land cover.

**Detention** – Controlling the peak discharge rate of stormwater from a site.

**Dewatering** – Removing water from an area or the environment using an approved technology or method, such as pumping.

**Director** – The Director of the Department of Energy and Environment (DOEE).

**District** – The District of Columbia.

**DOEE's submittal database** – An online platform managed by DOEE and accessible to the public that the Department uses to receive applications and make approval determinations.

**Drip Line** – Extent of the tree canopy.

**Drought Condition** – Areas experiencing drought as identified by the United States Drought Monitor (<https://droughtmonitor.unl.edu/>).

**Easement** – A right acquired by a person to use another person's land for a special purpose.

**Electronic media** – Means of communication via electronic equipment, including the internet.

**Erosion** – The process by which the ground surface, including soil and deposited material, is worn away by the action of wind, water, ice, or gravity.

**Excavation** – An act by which soil or rock is cut into, dug, quarried, uncovered, removed, displaced, or relocated and the conditions resulting from those actions.

**Exposed area** – Land that has been disturbed or land over which unstabilized soil or other erodible material is placed.

**Grading** – Causing disturbance of the earth, including excavating, filling, stockpiling of earth materials, grubbing, root mat or topsoil disturbance, or any combination of them.

**Green Area Ratio (GAR)** – The ratio of the weighted value of landscape elements to land area, as it relates to an increase in the quantity and quality of environmental performance of the urban landscape as defined in the zoning regulation (Chapter 34 of Title 11 of the District of Columbia Municipal Regulations). The GAR Guidebook is available at <https://doee.dc.gov/service/green-area-ratio-overview>.

**Heritage Tree** – A tree with a circumference of 100 inches or more.

**Impervious cover** – A surface area that has been compacted or covered with a layer of material that impedes or prevents the infiltration of water into the ground, examples include conventional streets, parking lots, rooftops, sidewalks, pathways with compacted sub-base, and any concrete, asphalt, or compacted gravel surface and other similar surfaces.

**Infiltration** – The passage or movement of surface water through the soil profile.

**Land cover** – Surface of land that is impervious, compacted, or natural.

**Land-cover change** – Conversion of land cover from one type to another, typically in order to comply with a requirement of this chapter or to earn certification of a Stormwater Retention Credit (SRC).

**Land-disturbing activity** – Movement of earth, land, or sediment that disturbs the land surface and the related use of pervious land to support that movement. Land-disturbing activity includes stripping, grading, grubbing, trenching, excavating, transporting, and filling of land, as well as the use of pervious adjacent land for movement and storage of construction vehicles and materials. Additionally, land-disturbing activity includes excavation and other activities which expose soil within an existing building footprint only if at least one exterior wall is removed fully or in part during construction in order to accommodate movement of construction equipment, workers, or material. Land-disturbing activity does not include repaving or remilling that does not expose the underlying soil.

**Low impact development (LID)** – A land-planning and engineering-design approach to manage stormwater runoff within a development footprint. It emphasizes conservation, the use of on-site natural features, and structural stormwater BMPs to store, infiltrate, evapotranspire, retain, and detain rainfall as close to its source as possible with the goal of mimicking the runoff characteristics of natural cover.

**Maintenance agreement** – See Section 5.4.2, “Maintenance Agreement.”

**Maintenance contract** – See “maintenance agreement.”

**Maintenance responsibility** – See Section, “5.4.1 Maintenance Responsibility.”

**Maintenance plan** – Planned scheduled maintenance for the life of the BMP.

**Maintenance schedule** – See “maintenance plan.”

**Maintenance standards** – Detailed maintenance plan laid out in Exhibit C within declaration of covenants.

**Major land-disturbing activity** – Activity that disturbs, or is part of a common plan of development that disturbs, 5,000 square feet or greater of land area, and either or both:

(a) Any portion of the pre-project land cover is natural; and/or

(b) 2,500 square feet or greater of the post-project land cover is impervious or BMP area.

Multiple distinct areas that each disturb less than 5,000 square feet of land and that are in separate, non-adjacent sites do not constitute a major land-disturbing activity.

**Major regulated project** – A major land-disturbing activity or a major substantial improvement activity.

**Major substantial improvement activity** – Substantial improvement activity and associated land-disturbing activity, including such activities that are part of a common plan of development, for which the combined footprint of improved building and land-disturbing activity is 5,000 square feet or greater, and either or both:

(a) Any portion of the pre-project land cover is natural: and/or

(b) 2,500 square feet or greater of the post-project land cover is impervious or BMP area.

A major substantial improvement activity may include a substantial improvement activity that is not associated with land disturbance.

**Market value of a structure** – Assessed value of the structure for the most recent year, as recorded in the real property assessment database maintained by the District of Columbia’s Office of Tax and Revenue.

**Natural cover** – Land area that is dominated by vegetation and does not require regular human inputs such as irrigation, mowing, or fertilization to persist in a healthy condition. Examples include forest, meadow, or pasture.

**Nonstructural best management practice** – A land use, development, or management strategy to minimize the impact of stormwater runoff, including conservation of natural cover or disconnection of impervious surface.

**Off-site retention** – Use of a stormwater retention credit (SRC) or payment of in-lieu fee in order to achieve an off-site retention volume under these regulations.

**Off-site retention volume (Offv)** – A portion of a required stormwater retention volume or required water quality treatment volume that is not retained on-site.

**On-site retention** – Retention of a site’s stormwater on that site or via conveyance to a shared stormwater BMP on another site.

**On-site stormwater management** – Retention, detention, or treatment of stormwater on-site or via conveyance to a shared stormwater BMP.

**Original Stormwater Retention Credit (SRC) owner** – A person who is indicated as the proposed SRC owner in an application to DOEE for the certification of an SRC. The proposed SRC owner becomes the original SRC owner upon DOEE’s certification of the SRC.

**Owner** – The person who owns real estate or other property, or that person’s agent.

**Peak discharge** – The maximum rate of flow of water at a given point and time resulting from a storm event.

**Permeable athletic track** – A surface, including a surface made of synthetic material, located at a school or public park that is used for athletic purposes including biking, running, and walking, and that allows the infiltration of water into the ground. The track must have a minimum surface permeability of at least 10 inches per hour, in accordance with the ASTM F2898 Standard Test Method for Permeability of Synthetic Turf Sports Field Base Stone and Surface System by Non-confined Area Flood Test Method.

**Permeable playground surface** – A surface, including a surface made of synthetic material, located under a playground area at a school or public park, that allows the infiltration of water into the ground. The playground surface must have a minimum surface permeability of at least 10 inches per hour, in accordance with ASTM F2898 Standard Test Method for Permeability of Synthetic Turf Sports Field Base Stone and Surface System by Non-confined Area Flood Test Method.

**Person** – A legal entity, including an individual, partnership, firm, association, joint venture, public or private corporation, trust, estate, commission, board, public or private institution, cooperative, the Government of the District of Columbia and its agencies, and the federal government and its agencies.

**Pervious Area** – Area with a compacted cover designation set aside to receive stormwater runoff as part of an impervious surface disconnection practice.

**Post-development** – Describing conditions that may be reasonably expected to exist after completion of land development activity on a site.

**Practice** – A system, device, material, technique, process, or procedure that is used to control, reduce, or eliminate an impact from stormwater; except where the context indicates its more typical use as a term describing a custom, application, or usual way of doing something.

**Preconstruction meeting** – The mandatory meeting occurring prior to any construction, including the owner, the designer, the installer, and the DOEE inspector. This meeting must contain an on-site component to evaluate the SWMP against existing site conditions. This should include, at a minimum, a visual examination of land cover types, the tree preservation plan, boundaries of the CDA(s), the existing inlet elevation(s) to ensure they conform to original design.

**Predevelopment** – Describing conditions of meadow land and its relationship to stormwater before human disturbance of the land.

**Pre-project** – Describing conditions, including land covers, on a site that exist before the construction described in a Stormwater Management Plan has begun.

**Publicly owned or publicly financed project** – A project that is defined as follows:

- (a) That is District-owned or District-instrumentality owned;
- (b) Where at least fifteen percent (15%) of a project's total cost is District-financed or District-instrumentality financed; or
- (c) That includes a gift, lease, or sale from District-owned or District instrumentality-owned property to a private entity.

**Public right-of-way (PROW)** – The surface, the air space above the surface (including air space immediately adjacent to a private structure located on public space or in a public right-of-way), and the area below the surface of any public street, bridge, tunnel, highway, railway track, lane, path, alley, sidewalk, or boulevard.

**Public space** – All the publicly owned property between the property lines on a street, park, or other public property as such property lines are shown on the records of the District. This includes any roadway, tree space, sidewalk, or parking between such property lines, but it excludes adjacent parks and other public property that is not associated with the public right-of-way.

**Raze** – The complete removal of a building or other structure down to the ground or to its foundation.

**Responsible person** – Construction personnel knowledgeable in the principles and practices of erosion and sediment control and certified by a Department-approved soil erosion and sedimentation control training program to assess conditions at the construction site that would impact the effectiveness of a soil-erosion or sediment-control measure on the site.

**Retention** – Keeping a volume of stormwater runoff on-site through infiltration, evapotranspiration, storage for non-potable use, or some combination of these.

**Retention capacity** – The volume of stormwater that can be retained by a stormwater BMP or land cover.

**Retention failure** – Failure to retain a volume of stormwater for which there is an obligation to achieve retention, including retention that an applicant promises to achieve in order to receive DOEE-certified SRCs. Retention failure may result from a failure in construction, operation, or maintenance; a change in stormwater flow; or a fraud, misrepresentation, or error in an underlying premise in an application.

**Retrofit** – A stormwater BMP or land cover installed in a previously developed area to improve stormwater quality or reduce stormwater quantity relative to current conditions.

**Runoff** – That portion of precipitation (including snow-melt) that travels over the land surface, and also from rooftops, either as sheetflow or as channel flow, in small trickles and streams, into the main water courses.

**Sediment** – Soil, including soil transported or deposited by human activity or the action of wind, water, ice, or gravity.

**Sedimentation** – The deposition or transportation of soil or other surface materials from one place to another as a result of an erosion process.

**Shared best management practice** – A stormwater BMP, or combination of BMPs, providing stormwater management for stormwater conveyed from another site or sites.

**Single- or two-family house** – An individual house, townhouse, or rowhouse designed and used for occupancy by one or two families. An individual house, townhouse, or rowhouse that has been physically altered for use by more than one or two families is not considered a single- or two-family house.

**Site** – A tract, lot, or parcel of land, or a combination of tracts, lots, or parcels of land for which development is undertaken as part of a unit, sub-division, or project. The mere divestiture of ownership or control does not remove a property from inclusion in a site.

**Site Drainage Area (SDA)** – The area that drains stormwater from the site to a single discharge point or sheet flows from a single area off the site.

**Soil** – All earth material of whatever origin that overlies bedrock and may include the decomposed zone of bedrock that can be readily excavated by mechanical equipment.

**Soil Erosion and Sediment Control Plan** – A set of drawings, calculations, specifications, details, and supporting documents related to minimizing or eliminating erosion and off-site sedimentation caused by stormwater on a construction site. It includes information on construction, installation, operation, and maintenance.

**Soils report** – A geotechnical report addressing all soil erosion and sediment control-related soil attributes, including but not limited to site soil drainage and stability.

**Special Tree** – A tree with a circumference between 44 inches and 99.9 inches.

**Storm sewer** – A system of pipes or other conduits that carries or stores intercepted surface runoff, street water, and other wash waters, or drainage, but excludes domestic sewage and industrial wastes.

**Stormwater** – Flow of water that results from runoff, snow melt runoff, and surface runoff and drainage.

**Stormwater management** – A system to control stormwater runoff with structural and nonstructural stormwater BMPs, including the following: (a) quantitative control of volume and rate of surface runoff and (b) qualitative control to reduce or eliminate pollutants in runoff.

**Stormwater Management Guidebook (SWMG)** – The current manual published by DOEE, and available on DOEE’s website, containing design criteria, specifications, and equations to be used for planning, design, construction, operation, and maintenance of a site and each stormwater BMP on the site.

**Stormwater Management Plan (SWMP)** – A set of drawings, calculations, specifications, details, and supporting documents related to the management of stormwater for a site. A SWMP includes information on construction, installation, operation, and maintenance.

**Stormwater Pollution Prevention Plan (SWPPP)** – A document that identifies potential sources of stormwater pollution at a construction site, describes practices to reduce pollutants in stormwater discharge from the site, and may identify procedures to achieve compliance.

**Stormwater Retention Credit (SRC)** – One gallon (1 gal.) of retention for one (1) year, as certified by DOEE.

**Stormwater Retention Credit ceiling** – Maximum retention for which DOEE will certify an SRC, calculated using the Stormwater Retention Volume equation with P equal to 1.7 inches.

**Stormwater Retention Volume (SWRV)** – Volume of stormwater from a site for which the site is required to achieve retention.

**Stripping** – An activity that removes or significantly disturbs the vegetative surface cover including clearing, grubbing of stumps and rock mat, and top soil removal.

**Substantial improvement** – A repair, alteration, addition, or improvement of a building or structure, the cost of which equals or exceeds fifty percent (50%) of the market value of the structure before the improvement or repair is started.

**Structural stormwater best management practice** – A practice engineered to minimize the impact of stormwater runoff, including a bioretention, green roof, permeable pavement, system to capture stormwater for non-potable uses, etc.



**Supplemental review** – A review that DOEE conducts after the review it conducts for a first resubmission of a plan.

**Swale** – A narrow low-lying stretch of land that gathers or carries surface water runoff.

**Total suspended solids (TSS)** – The entire amount of organic and inorganic particles dispersed in water. TSS is measured by several methods, which entail measuring the dry weight of sediment from a known volume of a subsample of the original.

**Waste material** – Construction debris, dredged spoils, solid waste, sewage, garbage, sludge, chemical wastes, biological materials, heat, wrecked or discarded equipment, rock, sand, cellar dirt, and industrial or municipal waste.

## Y.1 References

ASTM F2898-11, Standard Test Method for Permeability of Synthetic Turf Sports Field Base Stone and Surface System by Non-confined Area Flood Test Method, ASTM International, West Conshohocken, PA, 2011, [www.astm.org](http://www.astm.org)

United States Drought Monitor. <https://droughtmonitor.unl.edu/>